

GIFT OF

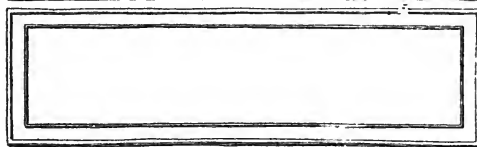

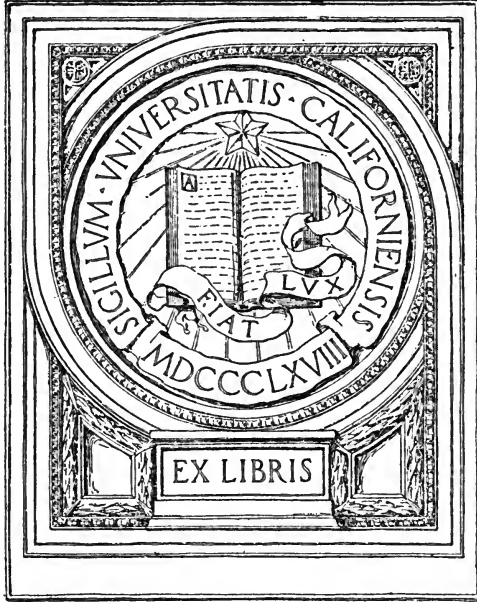

Digitized by the Internet Archive
in 2007 with funding from
Microsoft Corporation

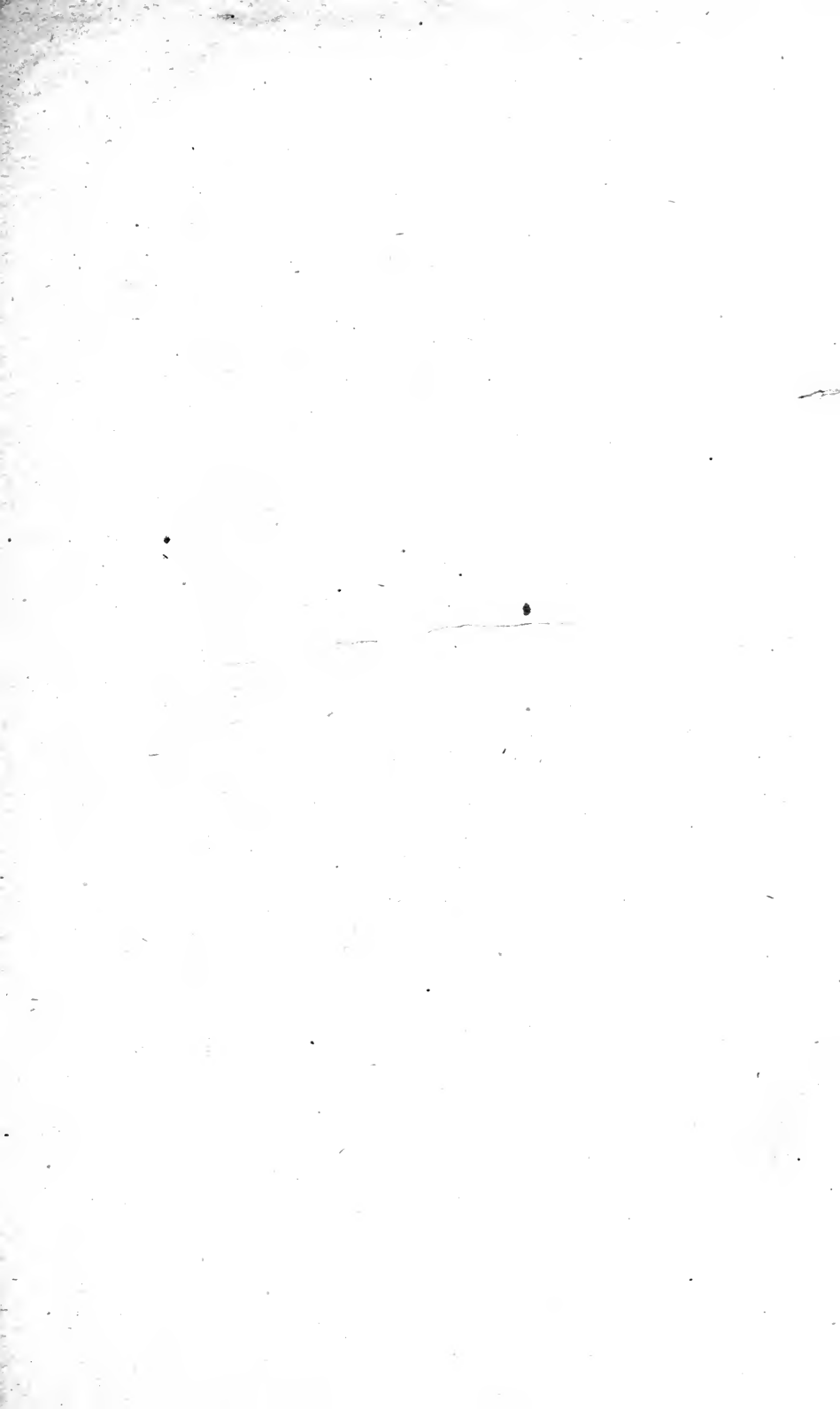



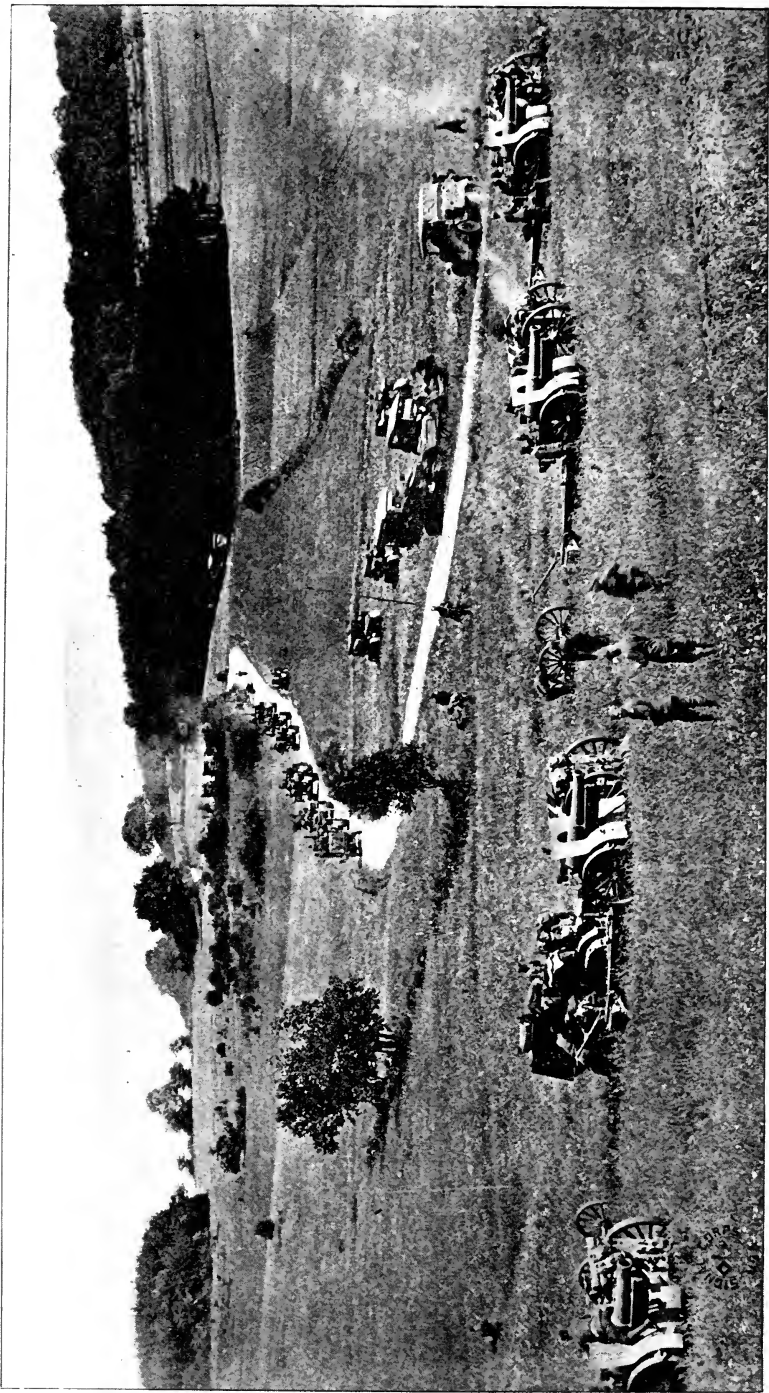

FRONTISPIECE.

HANDBOOK OF ARTILLERY

INCLUDING
MOBILE, ANTI-AIRCRAFT
AND TRENCH MATÉRIEL

PREPARED IN THE OFFICE OF
THE CHIEF OF ORDNANCE

May, 1920



WASHINGTON
GOVERNMENT PRINTING OFFICE
1920

2/5/1

UF153
A3

9/19/1917

ORDNANCE DEPARTMENT
Document No. 2033
Office of the Chief of Ordnance

TO AND
ADDRESS

WAR DEPARTMENT,

WASHINGTON, *May, 1920.*

The following publication, entitled "Textbook of Artillery, Including Mobile, Anti-Aircraft, and Trench Matériel," is published for the information and guidance of all students of the Ordnance training schools, and other similar educational organizations. The contents should not be republished without authority of the Chief of Ordnance, War Department, Washington, D. C.

BY ORDER OF THE SECRETARY OF WAR.

PEYTON C. MARCH,

General, Chief of Staff.

OFFICIAL:

P. C. HARRIS,

The Adjutant General.

(3)

432322

PREFACE.

The data in this book is compiled for use in the Ordnance training schools and other educational organizations where a short, yet comprehensive, survey of the existing calibers and types of guns and carriages now in use by the United States Army is desired. On this basis, the descriptions and drawings have been made simple and technicalities have been reduced to a minimum, bringing out the differences and similarities of the various types of artillery matériel. This publication has been prepared in the mobile gun carriage section of the Artillery Division. The general discussion on the design and characteristics of mobile artillery is intended for the instruction of student officers and enlisted specialists schools.

The first edition of this book is to be distributed to various educational institutions for a trial use in their classes and the results of this trial should be productive of many constructive criticisms so that the second edition will more fully meet the varied needs of the schools and training units. The intention is to revise this book periodically, therefore suggestions and criticisms are cordially invited. Communications should be addressed to the Chief of Artillery Division, Office of the Chief of Ordnance, Washington, D. C.

Murray H. Resni Coff.

LIST OF CONTENTS.

	Page.
List of illustrations.....	7
Table of equivalents.....	14
Brief history of guns and artillery matériel.....	15
Artillery, classes of.....	21
Mobile artillery, types of.....	21
Guns, their functions and construction, including breech mechanisms.....	24
Mounts for mobile artillery.....	28
Recoil brakes and methods of counterrecoil.....	31
Aiming devices and sighting methods.....	39
Accompanying vehicles.....	45
37-millimeter gun matériel, model of 1916.....	50
37-millimeter (1 pounder) gun carriage (Bethlehem).....	56
2.95-inch Vickers-Maxim mountain gun matériel (with pack outfit).....	59
75-millimeter gun matériel:	
Model of 1916 matériel.....	65
Model of 1916 MI matériel.....	78
Model of 1897 MI (French) matériel.....	80
Model of 1917 (British) matériel.....	94
Gun carriage limber, model of 1917 (British).....	106
Gun carriage limber, model of 1918.....	110
Gun caisson, model of 1918.....	113
Gun caisson limber, model of 1918.....	116
3-inch gun matériel.....	118
Guns, models of 1902, 1904, and 1905, and carriage, model 1902.....	120
Gun limber, model of 1902.....	130
Gun caisson, model of 1902.....	132
Gun caisson, model of 1916.....	134
Gun limber, model of 1916.....	137
Battery wagon, model of 1902.....	138
Battery wagon, model of 1902 MI.....	139
Store wagon, model of 1902.....	140
Store wagon, model of 1902 MI.....	141
Forge limber, model of 1902.....	143
Store limber, model of 1902.....	146
Forge limber, model of 1902 MI.....	145
Store limber, model of 1902 MI.....	146
Battery and store wagon, model of 1917.....	147
Battery reel, model of 1907.....	150
Reel, model of 1909 MI.....	152
Cart, model of 1918.....	155
Wheels:	
56-inch (steel tired).....	158
57-inch by 3.5 inch (rubber tired).....	158
Reel, model of 1917, for caissons.....	159
Automatic pole support.....	160

	Page.
4.7-inch gun matériel.....	131
Gun and carriage, model of 1906.....	166
Gun carriage limber, model of 1905.....	175
Gun caisson, model of 1908.....	178
Gun limber, model of 1908.....	180
Gun caisson, model of 1916.....	182
Gun caisson, model of 1917.....	186
5-inch, 60-pounder gun matériel (British).....	189
Gun, Mark I, and carriage, Mark II.....	193
Gun carriage limber, Mark II.....	196
Ammunition wagon, Mark II.....	199
Ammunition wagon limber, Mark II.....	203
155 howitzer matériel, model of 1917 (Schneider).....	207
155 howitzer matériel, model of 1918 (Schneider).....	211
Howitzer and carriage, model of 1918.....	216
Howitzer carriage limber, model of 1918.....	223
Howitzer caisson, model of 1918.....	225
155 gun matériel (Filloux).....	229
Gun and carriage, model of 1918.....	234
Gun carriage limber, model of 1918.....	242
6-inch gun matériel, model of 1917 (British).....	245
7-inch naval tractor mount, Mark V.....	249
8-inch howitzer matériel (Vickers).....	259
Howitzers, Mark VI and VIII½, and carriages, Marks VI and VII.....	268
Howitzer carriage limber, model of 1917 (Vickers).....	278
Firing platform and wagon, model of 1917 (Vickers).....	281
9.2-inch howitzer matériel (Vickers).....	283
Howitzer and carriages, Marks I and II.....	288
Howitzer transport wagon.....	296
Howitzer carriage transport wagon.....	298
Howitzer platform transport wagon.....	299
240-millimeter howitzer matériel (Schneider).....	300
Howitzer and carriage, model of 1918.....	307
Accessories.....	312
Transport wagons and limbers.....	318
Antiaircraft artillery.....	322
3-inch antiaircraft gun matériel, model of 1918.....	326
3-inch antiaircraft gun mount, model of 1917.....	340
75-millimeter antiaircraft truck mount, model of 1917.....	354
French warfare matériel.....	365
3-inch Stokes' trench mortar, Mark I.....	369
6-inch Stokes' trench mortar, Mark I.....	373
Prospectus.....	378

LIST OF ILLUSTRATIONS.

	Page.
Frontispiece.	
Sixteenth-century artillery	16
French artillery, 1800-1850	18
Recoil brakes and methods of counterrecoil:	
Hydraulic brake (throttling bar)	32
Hydraulic brake (valve)	32
Hydraulic brake (central throttling)	33
Counterrecoil mechanism (spring, concentric columns)	34
Counterrecoil mechanism (spring, telescopic)	34
Hydro-spring recoil system	34
Hydro-pneumatic recoil system with floating piston	35
Hydro-pneumatic recoil system with fluid in direct contact with the air	35
Counterrecoil mechanism (hydro-pneumatic, central buffing)	36
Aiming devices:	
Elevating systems	40
Panoramic sight	41
Gunner's quadrant	42
Accompanying vehicles:	
Tractors hauling artillery	46
75 mm. gun carriage, mounted on trailer	47
37-millimeter gun matériel, model of 1916:	
Rear view of carriage in battery position	49
Carriage and ammunition cart, limbered	50
Left side view of tripod mount in battery position	51
Tripod mount in firing position	53
Gun disassembled on the march (wheels and axles left in the rear)	54
Gun and personnel on the march (ammunition cart left in the rear)	55
37-millimeter (1-pounder) gun carriage (Bethlehem):	
Side view of carriage	57
Rear view of carriage	58
2.95-inch Vickers-Maxim mountain-gun matériel (with pack outfit):	
Carriage in firing position	60
Pack outfit on mule back	61
Rear view of carriage in battery	62
Detailed view of gun	63
Side view of carriage in battery	64
75-millimeter gun matériel, model of 1916:	
Right side elevation of carriage	66
Front view of carriage	66
Plan view of carriage	67
Rear view of carriage	68
Left side view of carriage	69
Breech mechanism	72
Longitudinal section of recoil and counterrecoil mechanism	73
Gun at maximum elevation	74
Elevating mechanism	75
Carriage and limber in traveling position	76
Traversing mechanism	77

	Page.
75-millimeter matériel, model of 1897 M1 (French):	
Left rear view of carriage.....	81
Front view of carriage.....	82
Longitudinal section of gun and carriage.....	84
Breech mechanism.....	85
Right side elevation of carriage.....	87
Traversing and brake operating mechanism.....	88
Left side view of carriage.....	89
Abatage positions of carriage.....	90
Plan view of carriage.....	91
Sight, model of 1901.....	92
75-millimeter gun matériel, model of 1917 (British):	
Front view of carriage.....	94
Left side elevation of carriage.....	95
Rear and front elevations of carriage.....	96
Rear view of carriage.....	97
Breech mechanism.....	99
Recoil-controlling system.....	101
Elevating and range gear.....	103
Traversing gear.....	104
75-millimeter gun carriage limber, model of 1917 (British):	
Front view of limber.....	106
Right side elevation of limber.....	107
Rear and front elevations.....	108
Rear view of limber.....	109
75-millimeter gun carriage limber, model of 1918:	
Rear view of limber.....	111
Front view of limber.....	111
Assembled views of limber.....	112
75-millimeter gun caisson, model of 1918:	
Front view of caisson.....	113
Assembled views of gun caisson.....	114
Gun caisson and gun caisson limber, limbered.....	115
75-millimeter gun caisson limber, model of 1918:	
Front view of caisson limber.....	116
Assembled views of gun caisson limber.....	117
3-inch gun matériel, model of 1902:	
Front view of carriage.....	119
Rear view of carriage.....	119
Left side elevation of carriage.....	121
Gun, models 1902, 1904, and 1905.....	122
Breech mechanism.....	123
Recoil-controlling mechanism.....	125
Carriage and limber, hauled by tractor.....	126
Carriage and limber in traveling position.....	126
Range quadrant.....	127
Rear sight.....	128
3-inch gun limber, model of 1902:	
Rear view of limber.....	130
3-inch gun caisson, model of 1902:	
Front view of caisson.....	132
3-inch gun caisson, model of 1916:	
Front view, showing door swung upward exposing ammunition.....	134
Front and side elevations of caisson.....	135

	Page.
3-inch gun caisson limber, model of 1916:	
Side and rear elevations of caisson limber.....	136
Battery wagon, model of 1902 M1:	
Rear view of battery wagon.....	138
Store wagon, model of 1902:	
Side view of store wagon.....	140
Side view showing store wagon and limber, limbered..	142
Forge limber, model of 1902 M1:	
Top view showing interior of forge limber.....	143
Assembled views of forge limber.....	144
Store limber, model of 1902 M1:	
Top view showing interior of store limber.....	146
Battery and store wagon, model of 1917:	
Rear right side view of battery and store wagon.....	147
Assembled views of battery and store wagon.....	148
Battery reel, model of 1917:	
Left side view of battery reel.....	150
Reel, model of 1909 M1:	
Rear view of reel.....	152
Assembled views of reel.....	153
Front view of reel.....	154
Cart, model of 1918:	
View showing reel and cart, limbered.....	155
Rear view of cart.....	155
Assembled views of cart.....	156
56-inch wheel:	
Side view of wheel.....	158
Reel, model of 1917, for caissons:	
View showing reel mounted on caisson.....	159
Front and side elevations of reel.....	160
Automatic pole support:	
Sectional diagram of pole support.....	160
4.7-inch gun matériel, model of 1916:	
View showing carriage and limber in traveling position.....	161
Left side view of carriage in battery.....	162
Assembled views of carriage equipped with band brakes.....	163
Left front view of carriage equipped with band brakes.....	164
Assembled views of carriage equipped with tire brakes.....	165
Front view of carriage equipped with tire brakes.....	166
Breech mechanism.....	166
Firing mechanism.....	167
Longitudinal section of gun and carriage.....	168
Front view of carriage equipped with band brakes.....	169
Rear right view of carriage.....	170
Elevating and traversing mechanisms.....	170
Range quadrant.....	171
Rear view of carriage equipped with band brakes.....	172
Rear sight.....	173
Front view of carriage equipped with tire brakes.....	174
4.7-inch gun carriage limber, model of 1905:	
Front view of limber.....	175
Assembled views of limber.....	176
4.7-inch gun caisson, model of 1908:	
Right side view of caisson.....	178

	Page.
4.7-inch gun limber, model of 1908:	
View showing gun caisson and limber, limbered	180
4.7-inch gun caisson, model of 1916:	
Right front view showing chest doors open exposing diaphragms	182
Assembled views of gun caisson	183
Front view of gun caisson	184
4.7-inch gun caisson, model of 1917:	
Assembled views of gun caisson	187
5-inch (60-pounder) gun matériel (British):	
Rear left view of carriage in battery	189
Carriage and limber in traveling position	190
View showing trail connected to limber	191
Rear right view of carriage	194
5-inch (60-pounder) gun carriage limber, Mark II (British):	
Front view of carriage limber	196
Rear view of carriage limber	197
5-inch (60-pounder) ammunition wagon, Mark II (British):	
Front view of ammunition wagon	199
Rear view of ammunition wagon	200
Ammunition wagon and ammunition wagon limber, limbered	202
5-inch (60-pounder) ammunition wagon limber, Mark II (British):	
Front view of ammunition wagon limber	203
Rear view of ammunition wagon limber	204
155-millimeter howitzer matériel, model of 1917 (Schneider):	
Right side view of carriage in traveling position	207
Carriage in battery position (rear view)	208
Front view of carriage in battery position	209
Side view of carriage en route	209
155-millimeter howitzer matériel, model of 1918 (Schneider):	
Traveling position of carriage and limber	210
Assembled views of traveling position	212
Detail view of howitzer	214
Breech mechanism	215
Firing mechanism	217
Recoil and counterrecoil mechanism	218
Longitudinal section of howitzer and carriage	220
Quadrant sight	221
155-millimeter howitzer carriage limber, model of 1918 (Schneider):	
Plan and right side elevations	224
155-millimeter caisson, model of 1918 (Schneider):	
Rear view of caisson	225
General assembled views	226
Front view of caisson	228
155-millimeter gun matériel, model of 1918 (Filloux):	
Traveling position (right side)	229
Left-side view of carriage and limber in traveling position	230
Rear view of carriage in battery position	231
Carriage in traveling position (rear view)	231
Longitudinal section of gun and carriage	232
Maximum elevation of gun	234
Breech mechanism	235
Breech mechanism and counterbalance cylinder	236
Carriage in firing position	237
Rear view of carriage in traveling position	238
Accessories and caterpillar wheel shoes	239
Elevating and traversing mechanism	240

	Page.
155-millimeter gun carriage limber, model of 1918 (Filloux):	
Front view of limber.....	242
Front view of limber, showing caterpillar wheel shoes, mounted on wheels..	243
Detailed view of limber.....	244
6-inch gun matériel, model of 1917 (British):	
Plan view of carriage.....	246
Left-side elevation of carriage.....	247
7-inch naval tractor mount, Mark V:	
Carriage and limber in traveling position (front view).....	249
Rear view of carriage.....	250
Left-side view of carriage in battery.....	251
Carriage and limber in traveling position (rear view).....	253
Top carriage and axle details.....	254
Assembled view of hydraulic brake.....	255
View of axle mounted in track layer.....	256
Side elevation of track layer.....	257
Carriage in battery position, showing maximum elevation of gun.....	258
8-inch howitzer matériel (Vickers):	
Carriage in battery position (Mark VI).....	259
Carriage and limber in traveling position (rear view).....	260
Carriage in battery position (Mark VII).....	262
Rear view of carriage, showing maximum elevation of howitzer.....	263
Right-side view of carriage in battery.....	264
Left-side elevation of Mark VI carriage.....	267
Rear right-side of carriage in firing position.....	268
Detailed view of howitzer (Mark VI).....	269
Breech mechanism of Mark VI howitzer.....	270
Breech block.....	271
Firing mechanism.....	272
Front view of howitzer carriage.....	273
Elevating and traversing mechanism.....	274
Howitzer carriage mounted on firing platform.....	275
Sight assembled.....	276
8-inch howitzer carriage limber, firing platform and wagon, model of 1917 (Vickers):	
Limber in traveling position (front view).....	279
Matériel én train and in battery.....	280
9.2-inch howitzer matériel (Vickers):	
Left-side elevation of carriages assembled.....	284
Front view showing maximum elevation of howitzer.....	285
Loading position, showing shell on tray.....	286
Longitudinal section of carriage.....	287
Rear view of carriage, showing howitzer at maximum elevation.....	288
Breech mechanism (Mark I).....	289
Breech mechanism (Mark II).....	290
Gear regulating recoil.....	291
Method of loading, showing loading gear mechanism in action.....	292
Right-side view of carriage in battery.....	292
Traversing gear.....	293
Sight assembled.....	294
9.2-inch howitzer transport wagon (Vickers):	
Method of mounting howitzer.....	296
Matériel én train.....	297

	Page.
240-millimeter matériel, model of 1918 (Schneider):	
Front view of carriage, showing maximum elevation of howitzer.....	300
Matériel én train.....	301
Carriage in loading position.....	302
Method of loading the howitzer with rammer car.....	304
Left elevation of carriage with howitzer at maximum elevation.....	305
Breech mechanism.....	306
Mounting the cradle.....	308
Recoil and recuperator mechanism.....	309
Elevating and quick-loading gear mechanism.....	310
Mounting the top carriage.....	311
Method of lowering platform.....	312
Sight assembled.....	313
Erecting frame in position.....	314
Left-side view of carriage.....	316
Mounting the howitzer.....	317
240-millimeter howitzer transport limbers and wagons:	
Howitzer transport wagon.....	318
Cradle transport wagon.....	318
Top carriage transport wagon.....	319
Platform transport wagon.....	319
Antiaircraft artillery:	
Antiaircraft artillery in action.....	323
3-inch antiaircraft gun matériel, model of 1918:	
Carriage in traveling position.....	325
Carriage in battery position (front view).....	327
View showing outriggers folded.....	328
Longitudinal section of carriage.....	329
Breech mechanism.....	330
View showing right rear outrigger with jack spade and float removed.....	332
Side view of carriage in battery position.....	333
Assembled view showing carriage in firing position.....	335
Front view of trailer.....	336
Sight on left side of carriage.....	337
Sight on right side of carriage.....	338
3-inch antiaircraft gun mount, model of 1917:	
View showing mount in action.....	340
Longitudinal section of gun mount.....	341
Right side elevation of gun mount.....	342
View showing right side of mount.....	343
Breech mechanism.....	345
Vertical section showing breech open.....	346
Elevating and traversing mechanisms.....	349
Left side elevation of gun mount.....	350
75-millimeter antiaircraft truck mount, model of 1917:	
Truck in traveling position (right side view).....	354
Plan view of truck mount.....	355
Sectional elevation of gun mount.....	356
View showing truck mount in action.....	357
Gun mount showing gun at maximum elevation.....	360
Truck in traveling position (left side view).....	361
Firing and stability jacks.....	363
Truck mount in battery position.....	364

	Page.
Trench warfare matériel:	
Trench warfare.....	366
Arrangement of trenches.....	367
3-inch Stokes's trench mortar, Mark I:	
Mortar in action.....	369
Front view of trench mortar.....	370
Rear view of trench mortar.....	371
6-inch trench mortar, Mark I:	
Diagrams showing preparation of trench mortar for action.....	374
Left side view of mortar.....	375
Method of loading trench mortar.....	376
Rear view of mortar.....	377
Self-propelled caterpillar Mark II:	
Plan view.....	379
Traveling position, front view.....	380
Traveling position, rear view.....	381

TABLE OF EQUIVALENTS.

1 mil.....	3.37 minutes.
1 degree.....	17.777 mils.
1 meter (m).....	39.37 inches.
1 centimeter (cm).....	0.3937 inch.
1 millimeter (mm).....	0.03937 inch.
1 kilogram (kg).....	2.2046 pounds.
1 dekagram (dk).....	0.3527 ounce.
1 gram.....	15.432 grains.
1 liter.....	1.05671 quarts (U. S.).
1 quart (U. S.).....	0.9463 liter.
1 inch.....	2.54 centimeters.
1 foot.....	0.3048 meter.
1 yard.....	0.9144 meter.
1 square inch.....	6.452 square centimeters.
1 kilogram (kg) per square centimeter.....	14.223 pounds per square inch.
1 cubic inch.....	16.39 cubic centimeters.
1 cubic foot.....	0.02832 cubic meter.
1 cubic yard.....	0.7645 cubic meter.
1 ounce.....	28.35 grams.
1 pound.....	0.4536 kilogram.

A BRIEF HISTORY OF GUNS AND ARTILLERY MATÉRIEL.

In taking up the study of guns, the student should know something of their history, the development of guns and gun carriages, and the reason for the various changes in ordnance matériel which have taken place from time to time.

The first use of guns or cannon as a medium for hurling projectiles by means of gunpowder is buried in obscurity; we have knowledge of Chinese using a form of gunpowder, not, however, for military purposes, but for pyrotechnics, at a period long before the Caucasians.

From the earliest times man has felt the want of arms that would kill at a distance, and the ingenuity of the talented has successively been taxed to produce such weapons. The readiest means at first was the throwing of stones or spears with the hand; but the effect of the missile proved so often insufficient that at once a desire arose to assist the muscles by the aid of some mechanical force. The sling was probably the first weapon used for hurling missiles. Its invention is attributed to the Phoenicians or the inhabitants of the Balearic Isles, who were extremely expert in its manipulation. The sling was used for many centuries as a military weapon, and its last appearance was at the Huguenot War of 1572.

The bow was probably invented about the same time as the sling, and for many centuries was considered the most effective offensive weapon in warfare. Great skill was attained by the ancients in its use, and many accounts are to be found relative to the extraordinary force and precision with which an arrow might be projected. The long-bow has always been more essentially the universal weapon, the cross-bow being a comparatively modern invention, and its use confined almost entirely to Europe. The cross-bow was greatly used for sporting as well as military purposes; and it must have been a cross-bow that William Tell employed in his notable feat. The Genoese and Gascons were the most famous cross-bow men in the armies of Europe. The cross-bow of the fourteenth and fifteenth centuries were sometimes made with sights affixed to them. Some specimens possessed a back sight having three or more peepholes, one over the other, which were evidently intended as guides for elevation.

The invention of gunpowder is possible to trace back to many centuries prior to the Christian era. Most writers upon this subject seem agreed that it was known to the Chinese and Indians, but the

descriptions given are so vague that it is difficult to make the various accounts coincide. The earliest mention we have of gunpowder is in the Gentoo Laws, where it is mentioned as applied to firearms. This particular code is believed to have been coeval with the time of Moses.

Gunpowder has been known in India and China far beyond all periods of investigation. There are many ancient Indian and Chinese words signifying weapons of fire, "heaven's thunder," "devouring fire," "ball containing terrestrial fire," and such like expressions.

The ancient Indians made great use of explosives, including gunpowder, in pyrotechnical displays. The introduction of powder into Europe took place early in the Christian era; some believe it was brought by the Moors into Spain and others that it came through the Greeks at Constantinople. Both may be correct, but certain it is that it, or a substance closely akin to it, was used at the siege of Constantinople in A. D. 668.

The Arabs, or Saracens, are said to have used it in A. D. 690, at the siege of Mecca.

The earliest mention of guns we have is that Seville was defended in 1247 by cannon throwing stones; Mibela in Spain was also defended by a machine resembling cannon, when besieged in 1259;

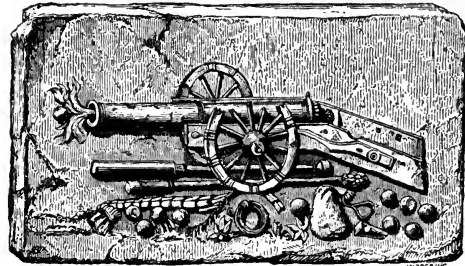

ARTILLERY OF THE SIXTEENTH CENTURY.

in 1273, Abou Yousof made use of cannon throwing stone balls at the siege of Sidgilmessa; and in 1308, Ferdinand IV of Castile, at the siege of Gibraltar, employed guns (or Marquinas de Truenas); and in 1311, Ismail attacked Bazas, a town of Granada, with machines throwing balls of fire with a noise resembling thunder. These seem to confirm the opinion that the use of cannon and powder was known to the Arabs or Moors and introduced by them into Spain, from whence it spread over Europe.

In the chronicle of the town of Ghent for 1313 it is stated that the town was possessed of a small cannon; and in the records of the Florentine Republic mention is made in the year 1325 of two officers being ordered to manufacture cannon and iron bullets for the defense of the castles and villages belonging to the Republic. The first German cannon belonged to the town of Amberg, and bears the date of 1301. The English appear to have imported them from Flanders, for King Edward III in 1327 employed some Hainaulters who used them in his war with the Scotch. In 1331 cannon were used by the King of Granada against Alicante, in 1339 at the siege of

Puy-Guillem, and in the same year at the siege of Cambray by Edward III, in 1340 by Lequesnoy before Mirepoix, in 1345 before Monsegur, and in 1346 at Crecy; we have many instances of cannon being used in the second half of the fourteenth century. About 1350 the North German knights had iron guns, and a little later the Free Hanse Towns armed themselves in the same way. In the year 1356 appear large amounts in the accounts of the town of Nuremberg as having been spent in purchasing cannon and guns; and in 1365 Duke Albert of Brandenburg defended Einbeck very effectually "with fire boxes."

The first records show that the Huns used artillery at the siege of Cividale, Italy, in 1331. The matériel was, of course, very crude and its effectiveness at that time depended largely upon the smoke and noise produced. The barrels, or cannons, in those days were constructed of wood, wrapped with wire or iron bands, and the projectiles were of stone. These guns were not mobile guns in any sense; they were transported with the utmost difficulty, and were subject to capture by sudden raids of the enemy.

The British were the first to actually bring the guns out into the field of warfare. They appeared at the Battle of Crecy in 1346, much to the dismay of the enemy. They shot anything that would go into the barrels of the guns, even bundles of arrows. The ordnance department of Edward III consisted of 340 men, with but 12 artillerymen, showing that at that time not much attention was paid to what is now an indispensable arm of the service. In 1415 the numbers had increased to 25 "master-gunners" and 50 "servitour-gunners." The gunner was the gun captain and had general charge of the gun and stores. In action he laid the piece and did the actual firing.

The early cannon of Europe were known by various names in the different countries. In Italy they were known as bombardes, probably derived from "a bombo et ardore" on account of the great noise which the firing of them occasioned. The French called them "quenon" or "cannon," the Germans "buchsen" or "boxes," and the Netherlanders "vogheleer" or "veugliares." Besides these terms there were many others applied to the various models, but it was not until the commencement of the fifteenth century that cannon were classified and named according to their size. Cannon was not adopted or manufactured in France until 1338, and even for many years afterwards the French looked upon those nations who used them as barbarians. The early cannon were made of wrought not cast metal, the first account we have of cast cannon being in 1378, when a founder named Aran, at Augsburg, in Germany, cast 30 of a metal composed of copper and tin. In 1413 Mahomed II, at the siege of Constantinople, had an enormous cast cannon. The bore

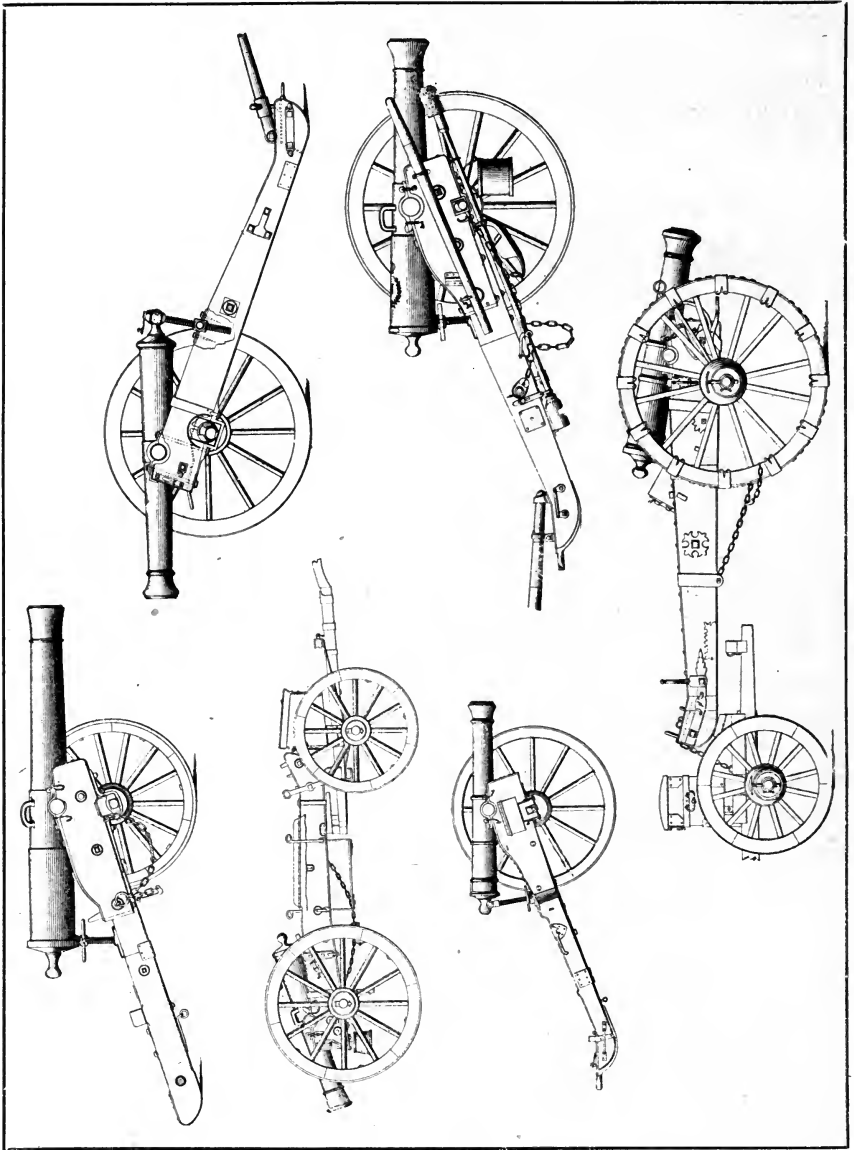

FRENCH ARTILLERY, 1800-1850.

is said to have been 48 inches in diameter and the stone bullet to have weighed 600 pounds.

The greatest example of artillery in the fifteenth century was at the siege of Constantinople in 1453, by the Turks. They used a type of mortar that hurled huge stones, some weighing 700 pounds. Some of these guns survived to engage the British in 1807; the majority of artillery at that date was for siege work. Barons who had quarrels with their neighbors would rent ordnance and go out and batter down their castles.

In the Italian wars waged by Charles VIII of France, artillery played a conspicuous part. However, they lacked the necessary mobility and, consequently, were captured and recaptured several times in a single engagement. At that, artillery had done some excellent work before small arms had attained any prominence. Although field artillery was introduced in the Hussite Wars, 1419 to 1424, it was not until the Thirty-Years War that they really displayed a mobile nature. The French had invented the limber, and the connection between it and the gun trail was made with a rope. The first gun that was moved by horsepower was mounted on an oblong frame, the gunner sitting directly behind the piece. The forepart of the oblong was mounted on two wheels and the rear end was supported by the horse which was inside of the oblong frame. The majority of the guns were 4-pounders, for as yet no way had been devised for the proper transportation of the heavier guns.

About the middle of the eighteenth century, guns were either 24, 12, 6, or 3 pounders; the units were divided into brigades of 4, 5, and 6 guns respectively, and began to be separated into heavy and light units. Each field gun was drawn by four horses with a cannoneer on each of the lead horses. The ammunition carried was 100 rounds of solid shot.

The howitzer, needed for its high angle of fire, put in its appearance in 1785, being introduced by the French Army. Horse artillery appeared in the French Army in 1791. In 1800 the horses were paired off with a driver on each near horse as is done to-day. In 1808, at Vimera, the first shrapnel came into use. It was known as case shot and the type used by Napoleon had a fuze that could be used for two different ranges. Napoleon also introduced the idea of massing artillery along a long front. Between 1860 and 1870 rifling appeared; this caused sighting to be given greater consideration, as a rifled gun shoots very accurately. During our Civil War the smoothbore was generally used, although rifled guns had made their appearance toward the close of the conflict. Direct laying was the only method of fire employed at this time. With the breechblock came the quick-firing gun. This called for a recoil mechanism, in order that the lay of the piece would not be seriously disturbed as a result of

firing. The vast amount of smoke produced with the powder then in use hid the target from the gunner and, unless quite a wind was blowing, the shooting was slow, but with the development of smokeless powder in the late nineties, this latter fault was done away with and rapid firing was possible. The first shields were put on the guns about this time also, protecting the gun personnel and making the piece more difficult to put out of commission.

The recent great struggle in Europe has brought about conditions and problems which heretofore have never existed in warfare. To meet these, sweeping changes have been made in almost every arm of the service, but probably the greatest and most radical change has been the motorization of the artillery.

Heretofore successful advances by the troops were limited to comparatively short distances, due to the impossibility of advancing artillery, ammunition, and supplies over grounds which are often muddy, full of shell holes, and otherwise difficult to maneuver with enough rapidity to keep up with the advancing infantry troops. The problem of transporting army equipment in the field led to the introduction of tractors and motor trucks.

The development of the caterpillar tractor used for hauling field artillery, which is able to negotiate almost any kind of terrain on the battle field, led to the question of the possibility of mounting guns directly on a self-propelled vehicle equipped with caterpillar treads. Early in 1918, an 8-inch howitzer was mounted on a self-propelled caterpillar and was fired at angles of elevation varying from 0° to 45° with very satisfactory results. This experimental caterpillar was tested, and it was found to be practical, easy to maneuver, and able to withstand the firing strain of the howitzer. As a result of this test, several types of experimental self-propelled caterpillar units are being built with armaments varying from 75-millimeter guns to 240-millimeter howitzers.

ARTILLERY.

Artillery has come to mean all firearms not carried or used by hand, excepting machine guns. Artillery is divided into two general classifications: Artillery of position and mobile artillery.

Artillery of position is that which is permanently mounted in fortifications.

Mobile artillery consists of two classes: First, the artillery designed to accompany an army in the field; second, railway artillery, which requires tracks for its transportation. The first type only is discussed in this book.

MOBILE ARTILLERY.

In designing any gun intended for use in the field, there are two important requirements—power and mobility. Granting that a general type of gun has been decided upon, it is evident that any increase in either of these two factors is at the expense of the other. It is necessary to balance the two, keeping in mind the specific purpose of the gun under consideration. We thus find it necessary to have several distinct classes of guns, ranging from the very powerful and almost immobile, to the very mobile and comparatively weak. The general classification is heavy field, light field, mountain guns or pack howitzers, trench mortars, and infantry accompanying guns and howitzers.

Besides this classification, based upon power, there is a second, based upon the shape of the trajectory. For the attack of targets that can be reached by it, flat trajectory fire is preferred on account of its power and accuracy. Cases frequently arise, however, where such fire is useless, either the gun or its target being so concealed and sheltered by intrenchments or the condition of the terrain that higher angles of departure and fall become necessary.

To provide for both cases, there are two or three types of weapon—the long gun for flat trajectory, the shorter howitzer for curved trajectory, and sometimes the still shorter mortar for high-angle fire. We thus subdivide our original classes and distinguish, for example, the light field howitzer, the heavy field gun, etc. Evidently the number of separate calibers that might be adopted to make up a complete series of types is very large. But it is important to reduce this number to a minimum, both from considerations of economy and also to avoid complication in ammunition supplies.

Guns were ordinarily intended for attack of targets that can be reached by direct fire; that is, by fire at angles of elevation not exceed-

ing about 15° . For the attack of targets that are protected against direct fire and for use in positions that are so sheltered that direct fire can not be utilized, curved fire—that is, fire at elevations exceeding 15° —is necessary. There is, therefore, provided the howitzer, a short gun designed to fire at comparatively large angles of elevation.

Field guns are now designed which permit fire at elevations as high or higher than is permitted by the howitzers. This is particularly true of anti-aircraft guns and those designed for use against entrenched positions. This development is an improvement in the effectiveness of the field gun, but it will not eliminate the use of howitzers of equal mobility, as the latter use projectiles of much greater weight than that of same caliber gun matériel.

The original American plan of field artillery design provided for each caliber of gun a howitzer of equal degree of mobility. In furtherance of this idea and to reduce to a minimum the number of calibers of mobile artillery and thus simplify as far as possible the supply of ammunition, the calibers of the guns and howitzers were so selected that while both guns and howitzers fulfilled the requirements as to weight and power for each degree of mobility the caliber of each was the same as that of the gun of the next lower degree of mobility. That is, the howitzer corresponding in mobility to one of the guns is of the same caliber as the next heaviest gun. The recent developments in American artillery, as well as the introduction of artillery of foreign design into the American service, have sustained this principle.

Under ordinary conditions the 3-inch field gun with its weight of about 3,900 pounds behind a six-horse team, is about as powerful a gun as can follow an army in motion. For this reason a gun of approximately this caliber has been adopted by most nations as the principal field gun.

The artillery of all military powers now comprises what are known as "rapid-fire" or "quick-firing" guns. This designation is too firmly established to be changed, although it can not be considered as accurately descriptive since rapidity of fire is characteristic of nearly all modern types. The real distinguishing mark of a rapid-fire gun is that its carriage does not move materially in firing; instead, the gun recoils on the carriage and is returned to the firing position by springs or their equivalent. There are a number of other features, some of which are found in all rapid-fire models; but these are of secondary significance and either old ideas which could not be worked out practically before the development of the gun-recoil carriage or else improvements developed since in the effort to get the best results out of it. For example, it is useless to attach shields to a rigid carriage, for, since the cannoneers have to stand clear to avoid the recoil, they can not take advantage of them. Mechanism for traversing the

piece on its carriage is unnecessary with the rigid system, but becomes necessary as soon as we adopt a carriage that remains more or less firmly anchored to the ground. Fixed ammunition and instruments for indirect laying are not essentially a part of either a rigid or a gun-recoil system; they are sometimes used with the former and occasionally, but rarely, omitted from the latter; but they have their full value only in rapid-fire material.

Our mobile artillery is divided into the following classes:

(a) Divisional artillery, such as the 3-inch, 75 millimeter guns, and 155 millimeter howitzers.

(b) Corps artillery, such as the 4.7-inch and 155 millimeter guns.

(c) Army artillery, such as the 8-inch and 240 millimeter. Any caliber may, if required, be assigned to army artillery corps.

(d) Mountain or pack matériel transported on the backs of mules. For mountain service the system composed of gun and carriage must be capable of rapid dismantling into parts, none of which forms too heavy a load for a pack mule. The weight of the load including the saddle and equipment should not exceed 350 pounds. The mountain gun in our service is the 2.95-inch.

(e) Infantry accompanying guns, such as 37 millimeter.

(f) Trench mortars.

GUNS.

THEIR FUNCTIONS AND CONSTRUCTION.

“A gun is a machine by which the force of expanding gas is used for the purpose of propelling a projectile in a definite direction.”

The gun consists of a metal tube, closed at one end, of sufficient strength to resist the pressure of the expanding gases, in which is placed a projectile designed to move through the tube. The force of the expanding gases acting on the base of the projectile causes it to start on its flight in a definite direction. When the charge is ignited, the explosion or rapid combustion of the powder gives rise by its decomposition to a large amount of gas, which tends to expand and to occupy a space greater than that in which the powder was originally contained; consequently, it exerts a pressure in all directions, and the energy developed is utilized in forcing the projectile from the tube. The major portion of the energy is distributed as follows:

- (a) Energy of translation of the projectile.
- (b) Energy of rotation of the projectile.
- (c) Energy of translation, in recoil, of the gun.
- (d) Energy of translation of the unburnt charge and gases.
- (e) Energy consumed in overcoming the passive resistance of the projectile. This resistance arises from the friction of the projectile against the walls of the bore, and of the rotating band against the driving edges of the lands. In the first stages it also arises from the cutting of grooves in the rotating band by the lands.

The balance of the energy is expended by being lost as heat to the gun and that which remains in the gas as sensible or latent heat

It may be readily understood that during the travel of the projectile through the bore of the gun, from the instant of ignition of the charge until it has left the muzzle, tremendous rending stresses are set up in the tube. In the earlier days of ordnance construction, these stresses were met by sheer weight of metal; but as the weight of projectiles increased, with consequent increase in powder charges, this weight of metal became so great as to impede the desired mobility of the material. Consequently, forgings of refined and alloyed steels took the place of the castings or forgings of iron or simple steels.

As explosives increased in power, the plain tube, even though built of alloyed steels, became incapable of containing the chamber pressures, even though of excessive weight. This problem was finally met through the construction of built-up and wire-wrapped guns.

A gun is subjected to two fundamental stresses—a circumferential tension tending to split the gun open longitudinally, and a longitudinal tension tending to pull the gun apart lengthwise. The longitudinal strength of a gun is usually greatly in excess of any requirements. It is easy to demonstrate that any homogeneous gun, i. e., a gun made of solid material and not built up, soon reaches the limit of thickness beyond which additional thickness is practically useless in giving strength to resist circumferential stress. This is due to the fact that the stress on the metal near the bore is far higher than that on the outer portion and soon reaches its maximum resistance, which additional thickness of metal does not materially increase. The gun can, however, be arranged to withstand a considerably higher pressure by building it up on the principle of initial tensions. The inner layers of the metal are thereby compressed so that the gas pressure has first to reverse this compression and then extend the metal. The gun barrel (or tube) supported by the contraction of the outer hoops will then be able to endure a gas pressure which can be expressed as proportional to the initial *compression* plus the *extension*, whereas in the old type of solid gun it was proportional to the *extension* only.

In the built-up system, the outer jackets are shrunk one over the other so that the inner tube is placed in compression and the outer ones in tension.

In place of one or more of the jackets, a thin wire or ribbon of steel is sometimes wound around the tube and has exactly the same effect as shrinking thin jackets one over the other. This type is known as the wire-wound gun.

Guns may be composed of two, three, or more cylinders; though in practice guns are hardly ever built of more than four cylinders. All Army guns, except small howitzers or mortars, are of the built-up or wire-wrapped type.

Rifling consists of a number of helical grooves cut in the surface of the bore. The soft metal of the rotating band of the projectile is forced into these grooves and causes the projectile to take up the motion of rotation as it passes through the bore.

Rotation of the projectile around its longer axis is necessary for stability in flight. By twist of rifling is meant the inclination of one of the grooves to the element of the bore at any point. Rifling is of two kinds:

(a) Uniform twist, or that in which the twist is constant throughout the bore.

(b) Increasing twist, or that in which the twist increases from the breech toward the muzzle end of the bore.

The twist of rifling is usually expressed in number of calibers length of bore in which it makes one complete turn; this is called the twist in calibers. The twist actually required at the muzzle to maintain

the stability of the projectile in flight varies with the kind of projectile and with the muzzle velocity.

If a uniform twist is used, the driving force on the rotating band will be a maximum when the pressure in the gun is at maximum, or near the origin of rifling. The increasing twist serves to reduce the maximum driving force on the band, thus lessening the danger of stripping it with resultant loss of rotation of the projectile. This is its principal advantage over the uniform twist, though it also reduces slightly the maximum pressure in the gun. The principal disadvantage of increasing twist is the continued change of form necessary in the grooves pressed in the rotating band as the projectile passes through the bore. This results in increased friction and a higher value for the passive resistance than with a uniform twist. If the twist increases from zero at the breech, uniformly to the muzzle, the rate of change in the tangent to the groove is constant. A twist in this form would offer less resistance than the uniform twist to the initial rotation of the projectile. But to still further diminish this resistance, a twist that is at first less rapid than the uniformly increasing twist and later more rapid has been adopted for some rifled guns.

The breech mechanism comprises the breech block, the firing mechanism, and the mechanism for the insertion and withdrawal of the block. There are two general methods of closing the breech. In the first method the block is inserted from the rear. The block is provided with screw threads on its outer surface which engage in corresponding threads in the breech of the gun. In order to facilitate insertion and withdrawal of the block, the threads on the block and breech are interrupted. The surface of the block is divided into an even number of sectors and the threads of the alternate sectors are cut away. Similarly, the threads in the breech are cut away from those sectors opposite the threaded sectors on the block. The block may then be rapidly inserted nearly to its seat in the gun, and when turned through a comparatively small arc, say one-eighth or one-twelfth of a circle, depending upon the number of sectors into which the block is divided, the threads on the block and in the breech are fully engaged and the block is locked.

In the second method, a wedge-shaped block is seated in a slot cut in the breech of the gun at right angles to the bore and slides in the slot to close or open the breech.

Variations of these two methods will be noted in the detailed descriptions of the guns which follow:

The most notable variation from the above two types is the Nordenfeld type of breech mechanism, a rotating block construction found on the French 37-millimeter and 75-millimeter, described more fully and illustrated in the description of these guns.

The breechblock is usually supported in the jacket of the gun or in a breech ring screwed into the jacket. The seat in the jacket being of greater diameter than could be provided in the tube, the bearing surface of the screw threads on the block is increased and the length of the block may be diminished.

The slotted screw breechblock is used to a great extent in our service. Its advantages are uniform distribution in the gun of the longitudinal stress produced by the powder pressure and lightness permitted in the construction of the breech end of the gun. In the model of 1917, 3-inch anti-aircraft gun, however, and in the American 75-millimeter gun, the sliding block operating vertically has been adopted for the reason that it permits of simpler mechanism for semiautomatic operations.

Howitzers differ only slightly from guns in their construction. They are shorter in length and insomuch as the chamber pressures differ materially the necessity for the long jacket is eliminated. A shorter jacket, extending only a part of the length of the tube, shrunk on in the same manner, is generally used.

Interior ballistics treats of the motion of the projectile while still in the bore of the gun. It includes the study of the mode of combustion of the powder, the pressure developed, and the velocity of the projectile along the bore of the gun.

By means of the formulas developed, a study of interior ballistics has made it possible to design the granulation of the powder for a given gun so as to obtain the highest possible muzzle velocity with a given weight of projectile, while keeping the pressure along the bore within the limits imposed by the strength of the walls of the gun, and the weight of the charge low enough for convenient loading.

After the calculation of curves of velocity and pressure are made, the walls of the gun are calculated to withstand the expected pressure at each point from breech to muzzle.

MOUNTS FOR MOBILE ARTILLERY.

A modern gun carriage is expected to stand steady on firing, so that in the first place it requires no running up, and in the second place it maintains the direction of the gun so that only a slight correction in elevation and direction is required after each round. The carriage is maintained in position by the spade, which sinks into the ground, and by the friction of the wheels upon the ground. If the force of the recoiling gun were communicated directly to the anchored carriage the effect would be to make it jump violently, which would not only disturb the lay, but would prevent the cannoneers from maintaining their position. The hydraulic recoil brake is therefore interposed between gun and carriage.

If the gun were rigidly attached to the carriage the latter would be forced back a short distance at each round, and the whole of the recoil energy would have to be absorbed in that short motion. Instead of this, the gun alone is allowed to recoil several feet and although the recoil energy is in this case greater than it would be if gun and carriage recoiled together, yet it is so gradually communicated to the carriage that instead of a violent jerk we have a steady, uniform pull, the only effect of which is to slightly compress the earth behind the spade. In a well-designed carriage the amount of this pull is always less than that required to lift the wheels off the ground by rotating the carriage about the spade.

The only motion of the carriage which takes place is that due to the elastic bending and rebound of its parts under the cross strain set up in discharge. These strains are inevitable since the direction of recoil can not be always exactly in the line of the resistance of the earth behind the spade. This movement of the axis is known as jump and must be determined by experiment for the individual piece in its particular mounting.

The principal parts of the typical gun carriage are the cradle; a device for mounting the cradle—called in the different models a rocker, pintle yoke, or top carriage; the trail; the wheels and axle. The gun slides in recoil on the upper surface of the cradle and the cradle contains the recoil controlling parts.

In the design of the carriage the constructional difficulty lies not so much in preventing the carriage from recoiling, but in preventing the wheels from rising off the ground on the shock of discharge. The force of the recoil of the gun, acting in the line of motion of the center of gravity of the recoiling parts, tends to turn the carriage

over backwards about the point of the trail or center of the spade. This force is resisted by the weight of the gun and carriage, which tends to keep the wheels on the ground. The leverage with which the overturning force acts varies with the distance of its line of action above the center of the spade; the leverage with which the restraining force acts varies with the horizontal distance of the center of gravity of the gun and carriage from the center of the spade.

It follows that the steadiness of the carriage for a given muzzle energy may be promoted by four factors.

(a) Increasing the weight of the gun and recoiling parts. This reduces the recoil energy.

(b) Increasing the length of recoil allowed. This reduces the overturning pull.

(c) Keeping the gun as low as possible, either by reducing the height of the wheels or by cranking the axle downwards. This reduces the leverage of the overturning force.

(d) Increasing the length of the trail. This increases the leverage of the steadying force.

The well-designed gun carriage is one that combines these factors in a practical way, so as to give the greatest possible steadiness to the carriage, at the same time keeping within the limits of weight imposed by the necessity of mobility.

Gun carriages are so constructed as to permit movement of the piece in either a vertical or horizontal plane. These motions may be simultaneous if so desired, and by a proper combination of the two motions, the axis of a gun may be aligned in any desired direction within the limits of motion of its mount. The two kinds of motion are designated as follows: Rotation of the piece about a vertical axis, its inclination with the horizontal remaining unchanged, is called "traversing"; movement of the piece in a vertical plane, the horizontal projection of the axis of its bore remaining unchanged, is called "elevating."

Gun carriages are provided with mechanisms for giving the pieces accurately controlled motion in both azimuth and elevation. Two types of elevating mechanisms are in common use. The first is the telescopic screw. This gives a considerable length of screw for a short assembled length and gives a rapidity of action (since the movement of the inner screw is equal to the sum of the pitches of the outer and inner screw for each turn of the pinion), combined with the nicety of adjustment of a single screw of fine pitch.

In the second type the motion is communicated to rockers, attached to the bottom of the cradle, through the engagement of worms or pinions, with teeth cut on the circumference of the rockers.

This method is in use on all howitzers, and a great many guns. It allows for a very high angle of elevation, and when fitted with a quick-loading gear, allows for the rapid placing of the piece in loading position after firing.

Movement of the gun in azimuth is accomplished in several ways; one is to pivot the cradle of the gun in a saddle which itself pivots on a horizontal transom of the trail. Another is to mount the gun and elevating gear on some form of top carriage, and pivot this top carriage over the axle. Still another is to traverse the whole piece along the axle, pivoting on the spade. This is a method used by the French in some of their designs. It has the disadvantage of only allowing for a small angle of traverse.

The above principles of design are, of course, modified considerably in the case of semipermanent mounts which fire from platforms and for anti-aircraft guns which have special mountings suited to their special use.

RECOIL.

RECOIL BRAKES AND METHODS OF COUNTERRECOIL.

The stresses to which a gun carriage is subjected are due to the action of the expanding powder gases on the piece. Gun carriages are constructed either to hold the piece without recoil or to limit the recoil to a certain convenient length. In the first case, the maximum stress on the carriage is readily deduced from the maximum pressure in the gun. In the second case it becomes necessary to determine all the circumstances of recoil in order that the force acting at each instant may be known and the parts of the carriage designed to withstand this force and to absorb the recoil in the desired length.

Assume the gun to be so mounted that it may recoil horizontally and without resistance. On explosion of the charge, the parts of the system acted upon by the powder gases are the gun, the projectile, and the powder charge itself; the latter including at any instant both the unburned and the gaseous portion. While the projectile is in the bore, if we neglect the resistance of the air, none of the energy of the powder gases is expended outside the system. The center of gravity of the system is therefore fixed, and the sum of the quantities of motion in the different parts is zero. The movement of the powder gases will be principally in the direction of the projectile. By formula, the weight of the gun, projectile, and charge being known, the complete relations between the velocity, time, and length of free recoil may be established.

Thus far we have neglected all resistances and have considered the movement of the gun in recoil as unopposed. However, when the gun is mounted on a carriage the recoil brakes, of whatever character, begin to act as soon as recoil begins, and consequently the velocity of recoil is less at each instant of travel than when unopposed. It is evident that the higher the resistance offered by the recoil brakes, the shorter will be the total length of recoil. A little consideration will show that if the total resistance to recoil is made constant throughout the recoil, its value will be less than the maximum value of a variable total resistance which will stop the gun in the same length of recoil. For a given length of recoil, the constant resistance will therefore produce less strain in the carriage, and for this reason is usually adopted, except where stability can be increased by using a variable pull.

The recoil system of a gun carriage consists of a recoil brake for controlling the recoil and limiting its length, a counter-recoil mechanism for returning the gun to the firing position and keeping it there, and a counter-recoil brake or buffer to soften the shock as the gun runs into the firing position.

Recoil brakes of the friction type were formerly used. Pneumatic brakes were also used to some extent. Both have been entirely superseded by the hydraulic recoil brake.

A hydraulic recoil brake consists of a cylinder filled with liquid and a piston. Relative movement is given to the cylinder and piston by the recoil, and provision is made for the passage of the liquid

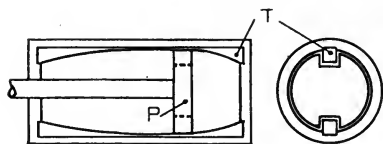

FIG. A.

from one side of the head of the piston to the other, by apertures cut into the piston or in the walls of the cylinder. The power of the brake lies in the pressure produced in the cylinder by the resistance offered by the liquid to motion

through the apertures. If the area of the apertures is constant, it is evident that the resistance to flow will be greater as the velocity of the piston or the velocity of recoil is greater. Therefore, the pressure in the cylinder, which measures the hydraulic resistance offered, will vary with the different values of the velocity of recoil. If, however, the apertures are constructed in such a manner that the area of aperture increases when the velocity of the piston increases, and diminishes when that velocity diminishes, the variation in the area of aperture may be so regulated, that the pressure in the cylinder will be constant, or will vary in such a manner as to keep the total resistance to recoil constant, or it may be made to vary in any manner desired.

In figure A is shown one type of hydraulic brake. It consists of a cylinder on the inner circumference of which are formed bars of varying cross sections, called throttling bars (T), piston (p), and piston rod.

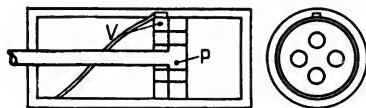

FIG. B.

Either the piston rod is secured to the carriage, the cylinder moving to the rear with the gun, or the cylinder is secured to the carriage, the piston moving to the rear inside of the cylinder. Through the piston head are cut slots or apertures through which the liquid is forced from one side of the piston to the other as the cylinder, or piston, moves in recoil. Each slot has the dimensions of the maximum section of the throttling bar with just enough clearance to permit operation. The area of orifice open for the flow of liquid at any position of the piston is therefore equal to the area of the slots minus the area of cross section of the throttling bars, and

is so determined that the resistance to the flow of the liquid, or the pressure in the cylinder, is made constant or variable, as desired.

In another type of hydraulic brake the throttling bars are not used, but the varying apertures are obtained by cutting grooves of varying width or depth on the interior of the cylinder.

Figure B represents another method of varying the throttling grooves. The piston (P) is held rigidly from turning and the valve (V) is rotated by means of a spiral groove cut in the cylinder walls, in which the lugs of the valve slide during recoil, thus rotating the valve and varying the size of the openings through the valve and piston. This method is used to a considerable extent in British design.

Figure C illustrates a method of central throttling. The throttling rod (R) has a varying diameter; this causes the amount of liquid, which flows between it and the hole in the piston (P), to vary in the manner necessary for correct throttling. This method is used in some French designs.

Counterrecoil, or the return of the gun to battery after completion of the recoil, may be effected by springs or by compressed air cylinders; the latter, in connection with the recoil brake, forming the hydro-pneumatic recoil system.

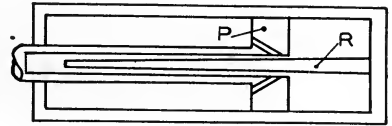

FIG. C.

The spring method of effecting counterrecoil may be used in all gun carriages on which the gun recoils in the direction of its axis. These include pedestal mounts, barbette carriages, turret mounts, and all wheeled carriages as shown in figures F and G.

In the smaller carriages of these types the springs, initially compressed to the desired amount, may be placed between the piston and the rear end of the hydraulic brake cylinder which is lengthened for that purpose.

In some carriages of this type the hydraulic brake cylinder moves with the gun in recoil, the piston being stationary. In such constructions the springs are usually placed around the hydraulic brake cylinder, and are compressed between a flange on that cylinder in front and some fixed part of the carriage in the rear.

In larger carriages the springs are arranged in separate cylinders with pistons of their own, two to four of these spring cylinders being required, see figures F and G.

Figure D shows a spring counter-recoil mechanism (spring recuperator) consisting of two concentric columns of springs.

It is sometimes necessary to use telescopic springs as shown in figure E, when a single column would not allow sufficient recoil.

These and other arrangements of counterrecoil springs will be further discussed in the description of the carriages to which they pertain.

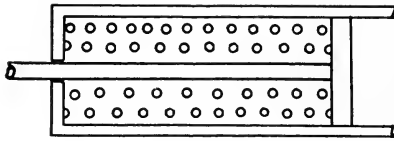

FIG. D.

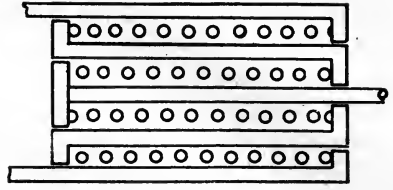

FIG. E.

Compressed gas (either air or nitrogen) is now very generally used to effect counterrecoil. Figures H, J, K, and L are diagrams of two designs of hydro-pneumatic recuperators.

In Figures H and J the recuperator piston (P) forces the oil from the recuperator cylinder into the gas reservoir through the port (A) when the gun recoils. Thus the gas is compressed and the necessary energy stored up to return the gun to battery. The piston may be attached to the gun and move with it, the cylinder being fastened to the carriage, or the cylinder may move and the piston

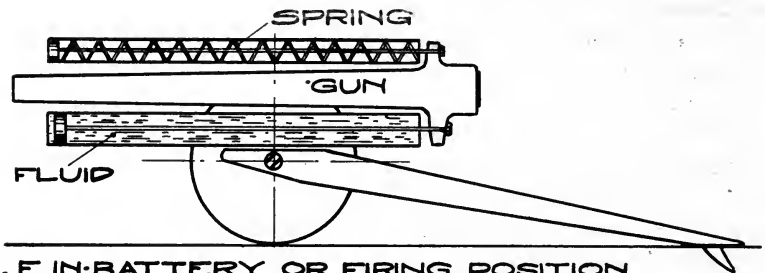

FIG. F IN BATTERY OR FIRING POSITION

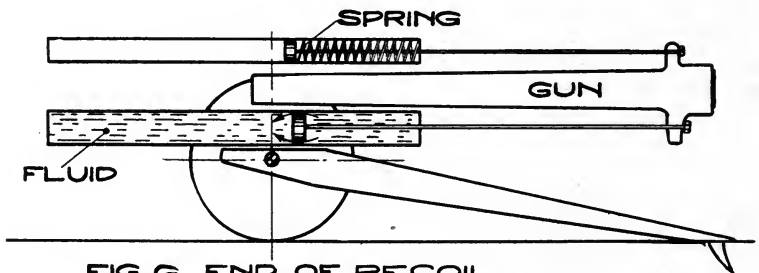

FIG. G END OF RECOIL

HYDRO-SPRING RECOIL SYSTEM

rod be fastened to the carriage. The gas is given sufficient initial compression to hold the gun in battery at all elevations.

The type of recuperator shown in figures K and L is similar in operation to that of figures H and J, but in the latter design the oil is separated from the gas by the floating piston (FP).

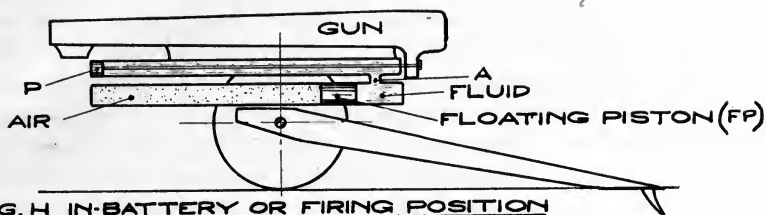

FIG. H IN-BATTERY OR FIRING POSITION

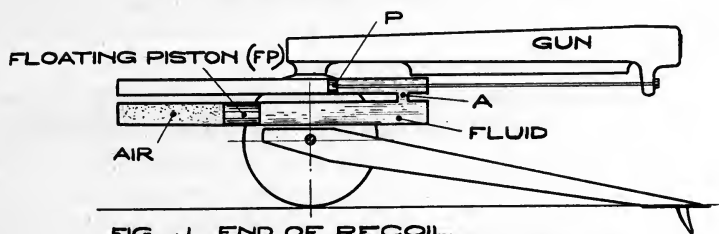

FIG. J END OF RECOIL

HYDRO-PNEUMATIC RECOIL SYSTEM WITH FLOATING PISTON

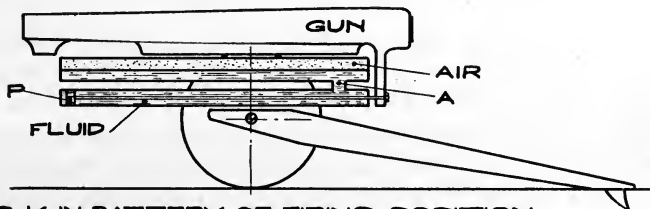

FIG. K IN-BATTERY OR FIRING POSITION

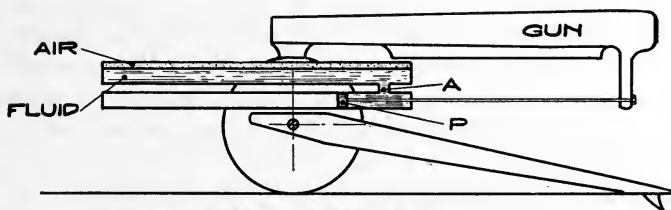

FIG. L END OF RECOIL

HYDRO-PNEUMATIC RECOIL SYSTEM WITH FLUID IN DIRECT CONTACT WITH THE AIR

The hydropneumatic recuperator (or counterrecoil mechanism) may be separated from the recoil brake or the two may be combined in one unit.

The principal advantages of air cylinders over spring cylinders for counterrecoil are the reduction in weight and longer life. These advantages are especially important in long-recoil field guns or howitzers designed to be fired at high angles of elevation. If springs are used the columns are long and heavy, being liable to breakage; while if air cylinders are used, the additional pressure needed when the guns are fired at high angles of elevation can be obtained by pumping more air into the cylinders.

It is evident that the energy, in whatever way obtained, which effects counterrecoil, forms a part of the total energy of recoil. The total resistance to recoil is composed of the resistance offered by the brake, the resistance due to friction, the resistance—either plus or minus—due to the inclination of the top of the chassis or the recoil

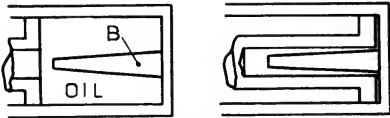

FIG. M.

slides, and the resistance due to the counterrecoil springs or air cylinders, if there are such included in the recoil system.

The counterrecoil buffer is provided for reducing the shock to the carriage as the gun is returned to the firing position by the counterrecoil mechanism.

In figure M is shown a type of buffer which is used to some extent. It consists of a rod (B) which acts inside the hollow piston rod of the recoil cylinder. A similar method to this is to provide a separate cylinder in which a projection of the recoil piston acts during the last few inches of recoil. It may consist of a dash pot formed at the end of the recoil cylinder.

The use of the counterrecoil buffer increases the stability of mobile artillery carriages by preventing their forward motion as the gun runs into battery.

Modern field guns and howitzers are mounted so as to have a long recoil on their carriages when fired horizontally. When certain types of these guns are fired at high angles of elevation it is necessary to reduce the length of recoil to prevent the breech of the gun from striking the ground. This reduction is effected by a mechanism which automatically reduces the size of the orifices in the hydraulic brake as the gun is elevated. This is known as variable recoil.

If no counterrecoil buffer is provided, the velocity of the gun when going into the firing position under the action of the counterrecoil springs or air cylinders is at a maximum just as it reaches that position. If an arrangement is made to automatically fire the gun when it has this maximum forward velocity, it is evident that the maximum

velocity of free recoil will be reduced by the amount of the forward velocity, and hence either the total resistance or the corresponding length of recoil, or both, can be materially reduced. Systems based upon this principle have been used abroad for small guns, such as mountain guns. The gun is caught by a pawl in the extreme recoil position and is loaded in that position. When it is desired to fire, the pawl is tripped, the gun runs forward, and is automatically fired as it reaches the firing position. The principal objections to this system, which is known as the differential recoil system, are the unsteadiness of the gun at the moment of firing and the possibility of the gun being turned over in a forward direction by the shock of counterrecoil if a misfire should occur.

In artillery of position, the gun carriage is rigidly bolted to a fixed platform. Its mechanism is such as to allow the gun and the attached parts to recoil on firing. The hydraulic brake cylinder and its piston are attached, respectively, to the moving and fixed parts of the carriage, or vice versa, in such a way as to cause the piston to be drawn through the cylinder as the gun recoils. When constant total resistance is to be exerted by the recoil system, which is always the case in artillery of position, either the total resistance or the length of recoil may be assumed, and the other determined. While the assumption of a very long recoil would reduce the resistance and consequently the strain on the carriage and permit its parts to be made lighter, the necessary increase in the length of the recoil slides might overbalance the saving in weight.

In carriages, such as mortar, anti-aircraft gun, and the latest type barbette carriages, all of which permit the firing of the gun at high angles of elevation, a very long recoil can not be used, because the distance from the breech of the gun to the supporting platform will not permit it. Furthermore, the use of a long recoil would necessitate the use of long and heavy columns of counter recoil springs. Lack of space also prevents the use of a long recoil on turret mounts.

In disappearing carriages, the length of recoil is determined more by the necessity of giving the gun the proper movement in recoil than by limitation of the strains brought upon the carriage.

With the exception of the disappearing and the older type of barbette carriages, the recoil for artillery of position is comparatively short.

The construction of all modern wheeled carriages is such as to allow the gun to recoil in the direction of its axis. The resistance to recoil developed by the recoil system pulls forward on the gun and backward on the carriage, tending to move the latter to the rear. Actual motion of the carriage to the rear is prevented by a spade sunk in the ground at the end of the trail of the carriage and so constructed as to present a broad surface to the ground in the rear.

Under ordinary conditions the ground will resist a pressure of 40 pounds per square inch of spade surface, and knowing the pressure developed by the pull of the piston rod, which is the only force acting on the carriage, the size of spade can be determined.

Another effect produced by the resistance to recoil is a tendency to rotate the carriage around the point of support of the trail, or to cause the wheels to jump from the ground. Such a movement is very undesirable, as it interferes with the rapid aiming and firing of the piece. In order to prevent the wheels from jumping off the ground when the gun is fired, it is necessary that the product of weight of the carriage including its recoiling parts and the horizontal distance of the vertical through their center of gravity from the point of support of the trail, should at any instant be greater than the product of the force opposing recoil and the perpendicular distance from its line of action to the point of support of the trail. The value of the total resistance to recoil, that will be just insufficient to cause the wheels to rise from the ground when the gun is in the firing position, is obtained by equating moments which will show that a value of this resistance small enough to prevent jump of the wheels in the early part of the recoil might still cause jump toward the end of the recoil, as the moment of the weight of the recoiling parts becomes less.

It is evident that safety against jump can be maintained and the necessary length of recoil shortened if, instead of assuming a constant total resistance, we assume it as decreasing to such an extent as to remain parallel to a line showing the maximum permissible values of the total resistance to recoil and plotted as a function of the length of recoil. If the length of recoil is such as to provide a factor of stability when the gun is fired at horizontal, the carriage will be stable at all higher elevations, as the lever arm of the total resistance of recoil decreases as the gun is elevated. For this reason, reduction of the length of recoil with increase of elevation in howitzer carriages does not affect their stability.

The initial strength of the counterrecoil spring columns or air cylinders is the force which they exert against the gun in the firing position. This force must be great enough to hold the gun in that position at the highest angle of elevation at which it is to be fired, as well as to overcome the friction on the recoil sides as the gun runs forward to the firing position.

AIMING DEVICES AND SIGHTING METHODS.

Sights will be discussed briefly in this pamphlet merely to indicate their application to field, anti-aircraft, and trench matériel.

In order that a projectile from any gun may hit the target, the gun must be fired at a certain angle of elevation depending on the range, the ballistic characteristics of the gun, and upon the relative level of the gun and target. It must be given such a direction to the right or left of the target as to offset the deviation of the projectile due to drift and wind. The sights of the gun provide means of determining when the axis of the gun has the predetermined direction.

When the piece is sighted, both in elevation and direction by sighting directly on the target, the method is known as direct laying. This is precisely the same operation as sighting a shoulder rifle or pistol. The line of sight may be fixed in one of two ways. The first method is to use plain or open sights, the rear one of which has a peep, or notch, capable of adjustment in a vertical or horizontal direction. This rear sight is equipped with an arc reading in fractions of the range, or degrees, by which the necessary elevation can be set off. In some cases the rear sight is designed to automatically correct for drift; if not, the drift must be set off on a scale provided for this purpose on the rear sight. It is always well to bear in mind that the projectile follows the movement of the rear sight, going higher as the sight is raised, and to the right or left as the sight is moved to the right or left.

The second method for direct laying is to use a telescope with cross hairs which takes the place of the open sights although its principle of operation is the same.

The angle of elevation of a gun must be measured in the vertical plane through the axis of the piece. It frequently happens that a mobile piece must be fired under conditions in which the axis about which it turns in elevation (trunnion axis) is not level, thereby throwing the sight plane out of the vertical. If this is the case, the sight arm must be revolved about an axis parallel to the axis of the gun until the sight arm is vertical. Most wheeled mounts have such a provision made on their sights.

Independent Line of Sight.

In order to relieve the gun pointer from the responsibility of setting the elevation on the sight standard and elevating the piece, some guns are provided with what is known as the independent line of sight. It will be noted that the actual quadrant elevation of the piece consists of two parts:

(a) The elevation necessary to reach the target if it were on the same level as the gun.

(b) The correction to this elevation required by the difference of level of the gun and target (angle of site).

With the independent line of sight the two parts of the quadrant elevation are applied to the gun independently. An intermediate rocker and two elevating systems, A and B, are provided as shown in Figure N.

The sight is fixed to the rocker, and for direct fire the gun pointer manipulates the lower elevation system A, which moves the rocker as well as the gun in elevation. In this way the angle of site is automatically corrected, when the line of sight is brought upon the target.

The other elevating mechanism, B, is between the rocker and the gun and is manipulated by another cannoneer who elevates the gun until the proper range appears on a range scale.

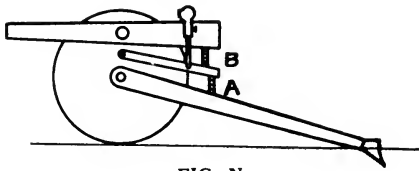

FIG. N.

The change in range does not affect the setting of the lower elevating mechanism, and the gun pointer is thus free to devote his whole time to keeping his line of

sight upon the target and is not compelled to take his eye from the telescope. The above method has the objection, however, that it is difficult to make the necessary correction in the range drum for difference in level of trunnion axis.

Various modifications of this general method of securing the independent line of sight are in use and will be discussed with the guns to which they pertain.

The gun is said to be laid indirectly when it is laid by means other than aiming directly through the sights at the targets.

The fire from modern field pieces is so accurate and destructive that it is always necessary to establish field batteries in position out of the view of the enemy for the sake of protection. Indirect sighting becomes then of necessity, the usual method of sighting such guns.

The panoramic sight affords the means of aiming the gun in indirect laying by directing the line of sight on any object in view from the gun; at the same time it affords the advantage of a telescopic sight in direct or indirect aiming.

This panoramic sight is a telescope so fitted with a rotating head, reflectors and prisms, that a magnified image of an object anywhere in view may be brought to the eye without change in the position of the observer's eye.

The panoramic sight is often mounted in connection with the range-sighting mechanism, but in some cases in order to divide the duties of laying for direction and elevation, the panoramic sight is mounted on a shank on the left side of the cradle and used in laying for direction, while the range quadrant for laying in elevation

is placed on the right side of the cradle and used by another cannoneer.

In connection with the range quadrant a range level is provided, which is a special form of clinometer. It is used in setting off the angle of site, thereby correcting for difference in level of the gun or target. The range quadrant is graduated in degrees or in fractions of the range (mils). In the case of howitzers, the different zones of fire are sometimes shown.

While the use of the range quadrant separates the duties of the cannoneers in aiming, it does not comply with the conditions for the independent line of sight. The sight and range quadrant being attached to the cradle, both move in elevation with the gun. The independent line of sight permits of the gun being moved and set in elevation without any change in position of the sight used for direction aiming.

Leveling plates or similar surfaces are provided on all guns and howitzers on which a gunner's quadrant (see p. 42) can be used in obtaining or checking the elevation.

It is not the intention to go into detail in this handbook regarding the fire-control equipment employed for directing the fire of anti-aircraft matériel, but as the development is so new, and they are so closely involved with artillery during operations, it is quite necessary to devote some space to the fire-control equipment.

Many of the terms and instruments used in connection with anti-aircraft artillery are similar to those employed with field artillery matériel, but the methods of application in most cases differ.

In the direct fire of anti-aircraft artillery the following angles resulting in the laying of the gun to the predicted future position of the target are involved.

1. Present azimuth and elevation. These are obtained by direct sighting upon the target.
2. Principal lateral and vertical deflections.
3. Secondary lateral and vertical deflections.
4. Superelevation.

In the determination of the principal lateral and vertical deflections, two methods of fire control have been established:

1. Linear speed.
2. Angular speed.



PANORAMIC SIGHT, MODEL OF 1917.

Each method assumes rectilinear travel of the target, i. e., that the pilot of the aircraft will fly a straight course at unchanging speed and constant altitude during the time required for the determination of the fuse range, setting of the fuse, loading and firing the gun, and for the projectile to reach its point of burst. Each method is based upon sound mathematical reasoning and involves automatic apparatus of rather complex, but easily operated, mechanical and electrical design, in order to resolve the data required in the laying of the gun.

In the first method the quantities required in the resolution of the formulæ are:

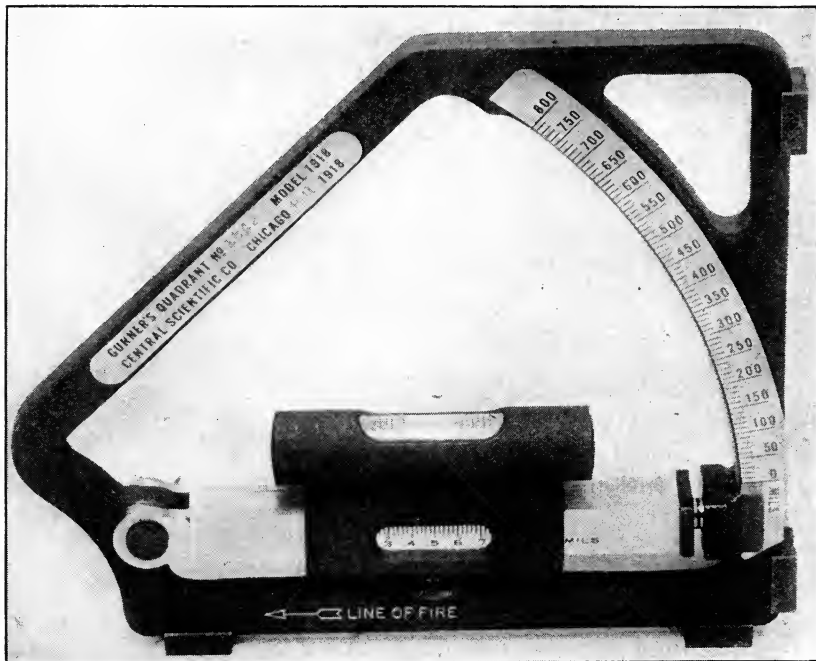

GUNNER'S QUADRANT, MODEL OF 1918.

(a) Presentation (angle of approach), i. e., the horizontal projection of the angle made between the vertical plane of sight and the axis of the fuselage of the airplane.

(b) Engine speed of the target.

(c) Altitude of the target.

(d) Time of flight of the projectile to the future position of the target.

The resolution of the formulæ deriving the lateral and vertical deflection corrections is accomplished upon a device known as "Anti-aircraft artillery deflection computer." The readings ultimately obtained from this instrument are given in mils. They are transmitted telephonically or by direct announcement to the gun layers who immediately lay the gun to its future position, while the

telescope pointers remain sighted upon the present position of the target.

The great advantage of this method lies in the fact that the presentation and engine speed can be estimated with reasonable accuracy. The altitude of the airplane is determined from altimetry stations, and the time of flight is known when fuse range has been determined from a telemeter.

In the angular speed method the lateral and vertical angular velocity of the target is measured. These are multiplied by the total element of time mentioned in the aforesaid and gives the respective displacements. The fact that the angular velocity of an airplane in ordinary flight is never uniform makes this method more difficult of apprehension but as applied in our instrument design gives results appreciably better than the linear speed method and is consequently used more generally. The instruments resolve the lateral and vertical deflection corrections in mils and also the fuse range. These are telephoned to the gun layers who function the sighting system mechanisms.

The element fuse range is required for two main purposes in anti-aircraft gunnery: (a) For the setting of the fuse, and (b) as a function in automatically giving superelevation to the gun—i. e., the angle between the line of sight to the predicted future position of the target and the axis of the bore of the gun when ready to fire.

Secondary deflections are required in making allowances for wind-age, ballistics, drift, etc. These are set by giving secondary movement to mechanisms of the sighting system.

When firing, "indirect" or at night, which essentially is indirect fire, three elements pertaining to the predicted future position of the target are transmitted from this apparatus at the fire-control station in order to accomplish the laying of the gun and setting of the fuse:

1. Azimuth.
2. Quadrant elevation.
3. Fuse range.

Secondary deflections involve, in addition to those common to direct firing, corrections for parallax when firing "indirect."

At night the alliance of listening apparatus and searchlights assist in accomplishing the resolution of the gun-laying elements at the fire-control station.

Altimetry, which is a basic factor in the computation of the principal and secondary deflection corrections, is obtained in one of two ways:

(a) *Monostatic.*

The monostatic or one-station instrument is an optical device that determines the altitude by automatic triangulation through the coincidence of light rays along a self-contained base.

(b) *Bistatic.*

This is a system in which two stations are set up and oriented along a base line of known length, frequently as great as 4,000 yards. The height or vertical distance of the target above the base line is then determined geometrically by projecting its altitude horizontally into the vertical plane passing through this base line.

When altitude has been determined, telemetry, which involves the functions, angle of site, to the future position of the target and altitude, is readily accomplished with the aid of automatic devices.

When firing against airplanes at night, searchlights are used to illuminate the objective. When it is able to find it and keep it in its field, firing can be conducted in the same manner as in daytime. Many sound detecting instruments have been made; one of the recent types is the "Paraboloid." A surface in the shape of a paraboloid, movable in azimuth and site, focuses the sound waves when its axis is placed in their direction; they swing from one side of the focus to the other when the axis of the instrument is turned. The sound is received by trumpets placed on either side of the focus and joined in pairs to the ears of two observers who adjust the instrument, the one for azimuth, the other for site.

Briefly, the foregoing describes the fundamentals of anti-aircraft artillery fire-control methods. Being the most precise form of gunnery, anti-aircraft artillery involves material capable of the highest degree of facility and accuracy in the automatic measurement of deflections and the maneuvering of its gun-laying mechanisms in order that effective fire may be conducted against a target whose movements are subject to such large displacements.

ACCOMPANYING VEHICLES.

In addition to the piece itself, a number of vehicles are necessary in batteries, sectors, and regimental organizations of field artillery for maneuvering and serving the piece. The type of vehicles vary with the different guns and the various organizations. Some of the more common vehicles such as limbers, caissons, etc., are described in a general way in this chapter, while their special features are described in detail with the matériel with which they are issued. Other special vehicles such as reels, store and battery wagons, etc., are also described with the matériel to which they pertain.

The caisson is essentially a conveyance for the transportation of ammunition in the field. It generally consists of a chest for ammunition mounted on two wheels and axle. In front it is fitted with a short pole having a lunette for attachment to other vehicles and in the rear with a pintle, to which additional vehicles may be attached. Various tools are usually carried on the caisson, and seats are provided for the accommodation of the personnel.

The limber is a two-wheeled vehicle designed primarily to increase the mobility and facilitate the maneuvering and deployment of field artillery. There are several types of limbers in use, the principal ones being the carriage and caisson limbers.

The carriage limber is attached to the trail of the piece when traveling. For light field pieces, a chest for ammunition is provided on the carriage limber. In the case of heavy pieces, the chest is dispensed with and the trail of the piece rests on the top section of the limber. A pole is provided at the front for horse or motor traction, and the rear is equipped with a pintle for attachment of the carriage.

The caisson limber is used for hauling the caisson and is provided with a chest for carrying ammunition.

The forge and store limbers are designed to carry supplies and equipment, the forge limber carrying the tools and supplies for the farriers shop. The battery wagon and the store wagon are two-wheeled vehicles equipped with chests for tools, supplies, and spare parts.

With batteries of heavier field artillery, some of the vehicles are dispensed with, especially the caissons, battery wagons, forge, and store limbers, the ammunition being carried in motor trucks, in which most of the spare parts and supplies are also carried.

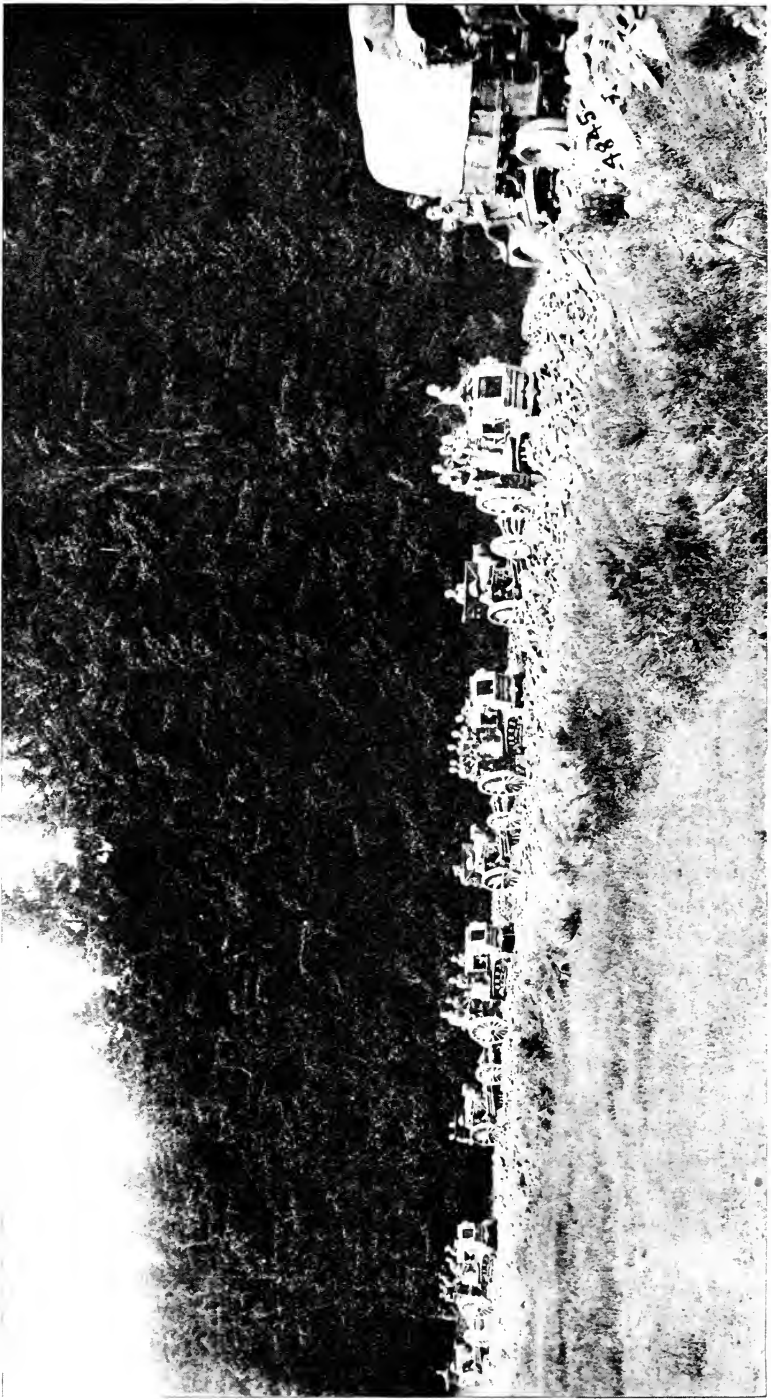

TRACTORS HAULING ARTILLERY.

Light field artillery is usually drawn by horses although some of these batteries are now motorized, i. e., hauled by either caterpillar tractors or motor trucks.

In addition to this, provisions are made for a limited number of trailers for use in carrying light guns at high speed behind motor vehicles. These trailers are rubber tired and for high-speed conditions; the complete gun, with carriage, may be placed on this trailer instead of being transported on its own wheels.

The recent struggle in Europe brought about problems which heretofore have never existed in warfare; and to meet these changes have been made in every arm of the service, but the greatest and

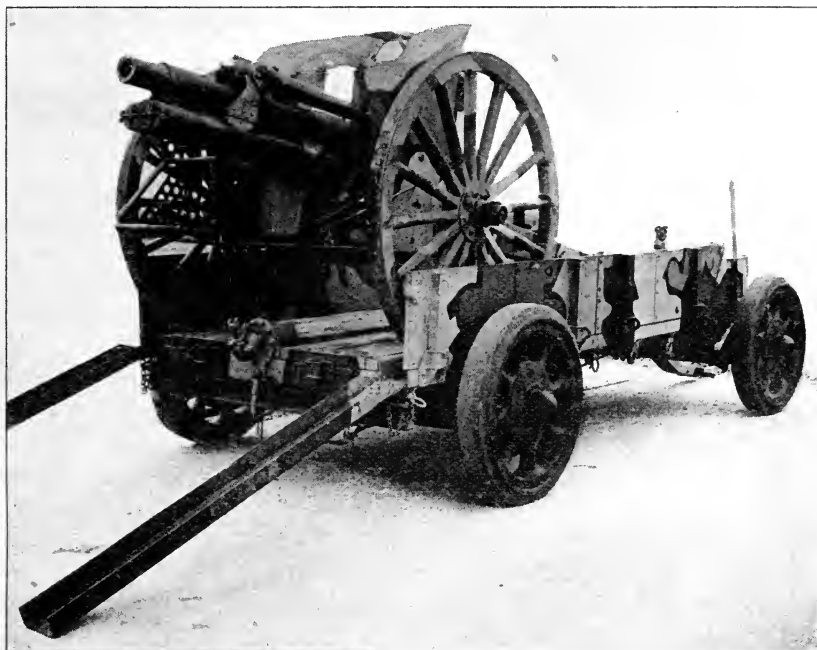

75-MILLIMETER GUN CARRIAGE MOUNTED ON A 3-INCH FIELD GUN TRAILER.

most radical change being the motorization of artillery. Mechanical transport is at this time in such a state of development that there is no need of dwelling upon its numerous advantages over animal draft.

The original heavy artillery was limited to guns emplaced in permanent fortifications and guns of large caliber which were only moved with great difficulty. Light horse-drawn guns and howitzers comprised the mobile artillery for use in the field. This type of artillery was ideal for quick action at short ranges.

As the artillery became a more important factor, large caliber long-range guns were required. The movements of this heavy artillery in

the field could only be accomplished in one way—by motorizing it. The result is the development of the extremely mobile heavy artillery.

In applying motor transportation to artillery, types of motor vehicles of widely varying capacity and duty are required. In most cases commercial cars and trucks are used, but in a few instances special types have been developed. Motor equipment is still undergoing changes, all tending to produce apparatus of unfailing dependability and maximum mobility and flexibility.

Motor apparatus of the following types have been selected as the most suitable for accomplishing this motorization: First, passenger cars, both light and heavy; second, motor cycles with and without side cars; third, trucks; fourth, four-wheeled trailers; and fifth, tractors of the caterpillar type.

Passenger cars are furnished when on the march and when occupying a position on the lines. Batteries are supplied with light touring cars, staff cars, and motorcycles with side cars. Battalion and regimental headquarters are also supplied with light touring cars and Westfield military bicycles. A motorcycle is ideal for liaison and work of similar nature requiring rapid transportation for one or two individuals. The motorcycle is particularly useful when traveling in convoy and for keeping the various units of an organization in close touch with each other.

Motor trucks are necessary for carrying supplies and ammunition from the depots and distributing them to the various units. A great many trucks are required to insure unfailing supplies when artillery is in action. Because of the uncertain conditions of the roads back of the lines sturdy trucks that can pull through under the most unfavorable conditions are employed.

In bringing the guns into position it is often necessary to cross ground plowed by exploded shells, to go through mud and deep sand, and to ford streams which can not be negotiated by a wheeled type of motor vehicle, thus the type of apparatus adapted for this purpose is the caterpillar tractor.

The problem of the care and maintenance of motor equipment in the field is met by issuing the repair and artillery supply trucks to each battery supply and headquarters company of motorized artillery.

The artillery supply truck is really a motorized store wagon carrying spare parts, tools, etc., for the particular kind of unit to which it is assigned.

The artillery repair truck consists of a small machine shop mounted on wheels. Its equipment is complete, including a lathe, drill press, air hammer, forge, etc. Electric power is supplied by a small generator driven by an individual gasoline motor mounted on the truck.

The equipment is designed to make all repairs in the field, both to artillery matériel and motor vehicles.

The motor equipment makes transportation a comparatively easy matter, permitting it to be moved with rapidity, either on the offensive or defensive. The value of this equipment becomes more apparent

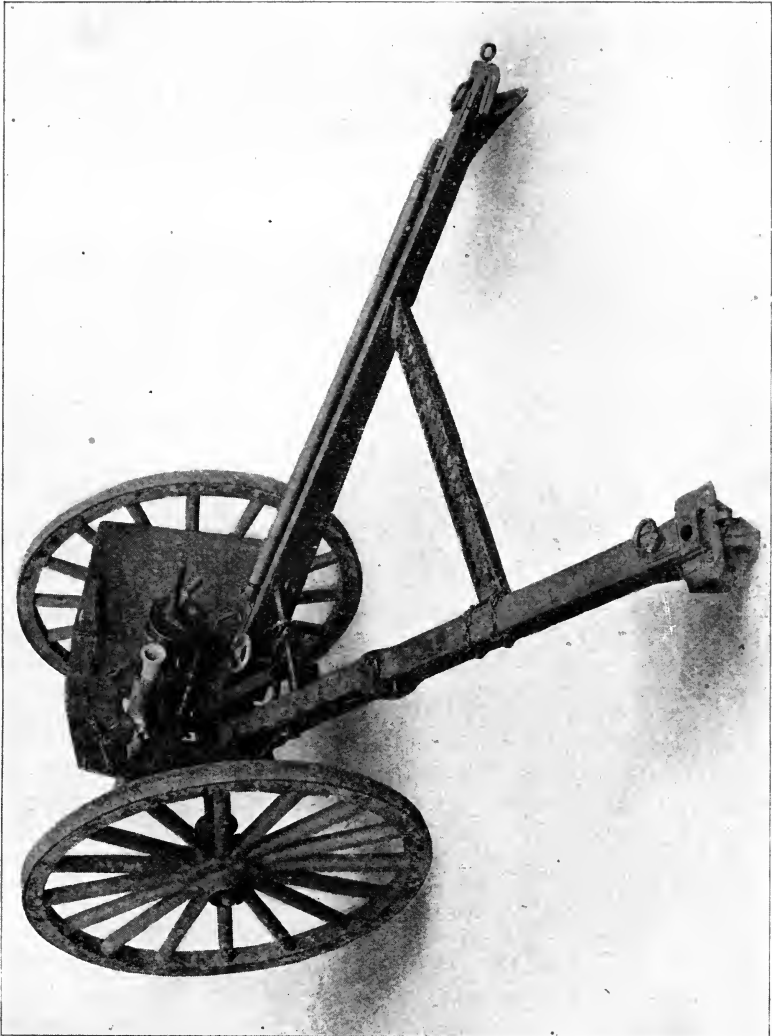

REAR VIEW OF 37-MILLIMETER GUN CARRIAGE, MODEL OF 1916, IN BATTERY POSITION.

as the nature of warfare changes from that of position to that of movement.

Detailed descriptions of the above motor vehicles are given in separate handbooks pertaining to motor equipment matériel.

37-MILLIMETER GUN MATÉRIEL, MODEL OF 1916.

Experience has shown that the infantry can not carry out its mission, by its own weapons, except at prohibitive loss of personnel. Our automatic rifle is practically useless for ranges greater than 500 meters, and then only against personnel. The individual rifle does not offer the necessary volume of fire, while the rifle grenade, and even more so, the hand grenade, is a close combat weapon. Hence the taking of a machine-gun nest by a unit (consisting of an automatic rifle squad, hand bombers, and rifle grenadiers) attacking the flanks, will not prove very successful, particularly if machine-gun nests are echeloned to considerable depth, and executing cross fire.

Such conditions calls for some form of artillery, effective at from 400 to 1,500 meters, against both personnel and matériel, and

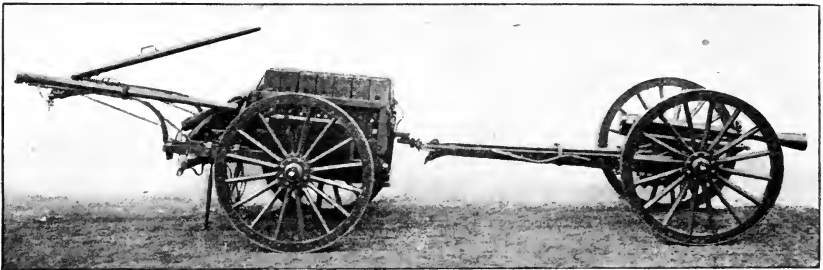

37-MILLIMETER GUN CARRIAGE AND AMMUNITION CART, LIMBERED.

capable of immediate action. The field artillery is not available because of difficulty of communication and length of time necessary to get into action. The heavy artillery is not sufficiently mobile. Its dispersion is too great for small, definite targets, thereby calling for vast amount of ammunition, extremely difficult to transport.

The necessity of providing an accompanying gun for certain units of infantry has led to the adoption of a 37-millimeter gun (developed by the French Army).

The 37-millimeter gun, also known as the 1-pounder or infantry accompanying gun, is the smallest weapon of the field-gun type in use by the American Army. It is used by advancing infantry outfits, chiefly for destroying concrete machine-gun emplacements, outposts, and other points of resistance. Recent developments and modifications of this weapon have found wide application for

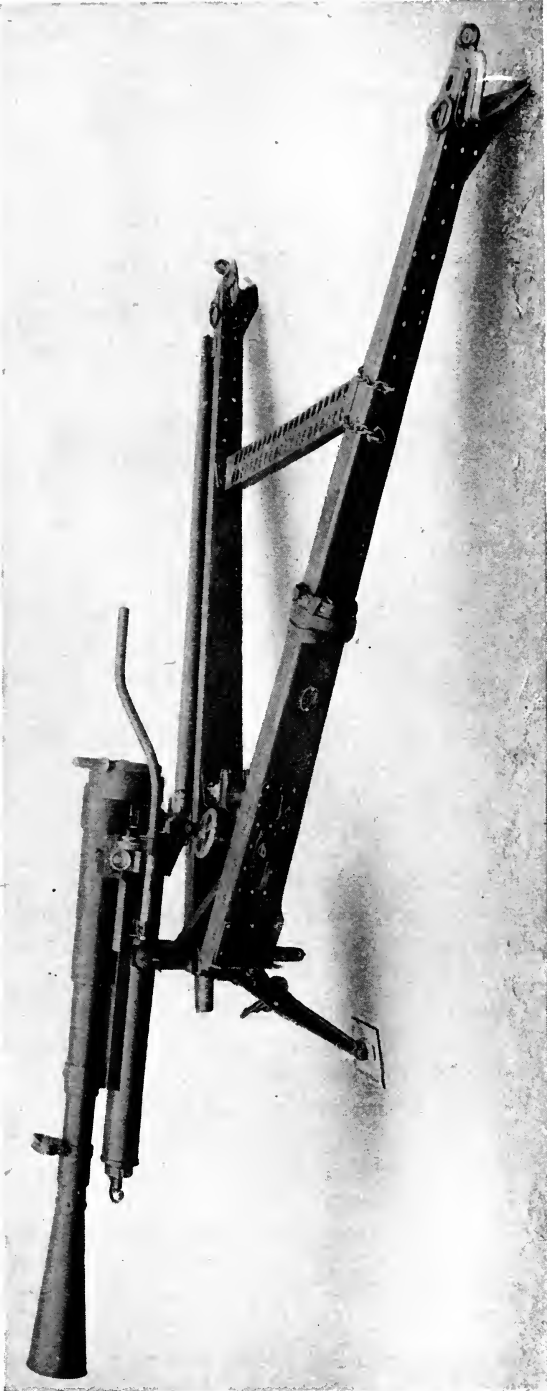

LEFT SIDE VIEW OF TRIPOD MOUNT IN BATTERY POSITION.

its use and, due to its extreme portability, this gun is adaptable for tanks, tractors, and aircraft.

As this gun is intended to follow infantry over any kind of ground, its construction is designed to give great mobility. The personnel is organized for rapid fire; the possible rapidity of fire is 35 shots per minute.

Each gun unit is composed essentially of two elements:

- (1) The gun on a tripod mount, capable of being set on wheels.
- (2) A light wagon serving as a limber and carrying ammunition, spare parts, and accessories.

The gun and limber when joined are normally hauled by one horse or mule, but near the enemy they are separated and moved by man.

In action the gun is operated by two men, one keeping it on the aiming point and the other loading and firing. The gun must be cocked by hand in order to load for the first round, but thereafter the counterrecoil of the barrel cocks the piece, and it is only necessary to open the breech mechanism, which ejects the case, insert a new cartridge, close the breech, and fire.

When used as a tripod mount, it is separated into portable groups for transportation and each unit is carried by two men. One group, weighing 104 pounds, consists of the gun and cradle and the other of the trails, weighing 84 pounds. With the combination tripod mount, the gun is transported on a wheeled carriage which is limbered to a two-wheeled ammunition cart, drawn by one mule or horse.

Weights, dimensions, and ballistics.

Weight of gun and recoil mechanism (with flash hider and sight)	pounds..	104
Weight of recoil group	do.	34
Weight of barrel group	do.	38
Weight of breech group	do.	18
Weight of flash hider	do.	2.5
Length of gun	calibers..	20
Range (H. E. Shell Mark II)	meters..	3,650
Muzzle velocity	feet per second..	1,204
Weight of projectile	pounds..	1.234
Length of recoil	inches..	7-10
Maximum angle of elevation	degrees..	21
Maximum angle of depression	do.	14
Amount of traverse to right	do.	22
Amount of traverse to left	do.	16
Weight of axle, complete	pounds..	36.25
Weight of wheels, each	do.	68
Weight of trails (including pintle and float)	do.	84
Diameter of wheels	inches..	37.75
Width of track	do.	33
Weight of gun and carriage, complete	pounds..	360
Over-all length of vehicle	inches..	75
Over-all height of vehicle	do.	37.75
Over all width of vehicle	do.	57

The gun is composed mainly of a steel alloy barrel. A front clip of bronze and an aluminum jacket serve as supports and guides for the whole barrel. The breech housing is screwed to the rear end of the barrel and forms a receptacle for the breechblock.

The breechblock is of the Nordenfeld type and with the exception of size is practically the same as that used on the French 75 millimeter field gun. It screws into the breech housing and is opened and closed by being rotated 156 degrees about its axis, which movement is limited in each direction by a stop. The breechblock is cylindrical in form, rotates in a threaded seat and is operated by a handle which when moved to the left causes the eccentric hole in the block to register with the bore and also operates the extractor thus ejecting the empty cartridge case. Pulling the lever to the right rotates the block so that the port in the block is drawn away from the bore and a solid surface containing the firing pin backs up to the base of the cartridge.

The action of the powder gases on the breechblock at the moment of discharge produces the recoil of the united barrel and breechblock.



TRIPOD MOUNT IN FIRING POSITION.

The purpose of the recoil mechanism is to control and limit the recoil and to return the barrel to the firing position, at the same time preventing a sudden return which might disturb the aim of the gun.

The recoil cylinder consists of a cylinder containing a piston, piston valve, counter recoil spring in three sections, and counterrecoil buffer. The piston rod, which is hollow and open at the piston end, is pierced with holes for the passage of oil both during recoil and counterrecoil. The piston is fitted with four holes for the passage of oil during recoil. This oil is allowed to pass through two parts of the piston; first, through the hollow portion of the piston rod, and second, through the holes in the piston head. The oil passages in the piston head are closed by the piston valve. The valve is held against the front face of the piston by a spring, closing the oil holes in the head during the counterrecoil stroke, thus slowing up the forward motion of the gun. The counterrecoil buffer is screwed into the front cylinder cap and eases the movement of the gun into battery, thus preventing excessive shock. The capacity of recoil cylinder is 2.75 pints and the extreme travel of piston is 11 inches.

The mount may be used either in the form of a tripod or with the axle and wheels attached. In the former case a front leg having a float adjustable to two heights at its lower end is used to support the front end of the mount, and the spread trails in rear equipped with spades form the other points of support. In the case of the wheels being used, the front leg is swung up and secured, and both trails are spread out to support the rear.

The pintle, or gun mount, is in the form of a yoke, the upper end being fitted to receive the cradle trunnions. Each trail head is equipped with lugs which pivot on bearing surfaces in the lower end of the pintle. The trails, when spread, are kept in position by a removable transom, which also serves as a seat for the gunner.

A Y-shaped frame, pivoted and secured to the pintle at its upper and lower ends, extends to the rear in the form of a fork and engages the nut housing on the traversing screw. The nut is turned in its housing by a small handwheel attached thereto, which causes the



GUN DISASSEMBLED ON THE MARCH (WHEELS AND AXLES LEFT IN THE REAR).

nut and housing to move along the screw, thereby traversing the gun. The screw is pivoted in the left trail and moves in and out through a bushing pivoted in the right trail when the trails are being spread or closed. When the trails are to be closed, the gun is traversed to the extreme right.

The elevating mechanism is located on the frame in front of the traversing mechanism. A screw fitting into a nut pivoted in the frame is raised and lowered by a handwheel attached to its upper end. Above the elevating handwheel is a hook engaging a pin fitted to the underside of the cradle, thus the rear end of gun is secured to the trail and the elevation accomplished when the cradle is mounted in the trunnion bearings.

A conical sheet metal flash hider is secured to the muzzle of the gun. Some of these carriages are equipped with an armor plate shield, suitably reinforced by stiffeners. The shield consists of three plates hinged together, and is mainly employed to protect the gunners from shrapnel and flying fragments.

The gun is provided with a telescopic sight for use in direct fire and a quadrant sight for indirect or masked fire, either of which is mounted on the left side of the gun and in a bracket which is part of the striker rod housing.

The wheels are 37.75 inches in diameter and have steel tires 1.875 inches in width.

The ammunition is of the fixed type having a steel projectile weighing 1.097 pounds containing high explosive, and detonated by a base percussion fuse. A complete round of ammunition weighs 1.47 pounds and is composed of projectile, brass case, primer, and powder charge.



GUN AND PERSONNEL ON THE MARCH (AMMUNITION CART LEFT IN THE REAR).

AMMUNITION CART FOR THE 37-MILLIMETER GUN.

The 37-millimeter gun limber (of the machine gun ammunition wagon type) is essentially a frame resting on two shafts having a movable bolt and rear fittings by means of which it can be joined to the gun mount.

The limber carries 14 ammunition boxes, each containing 16 cartridges packed in a fiber packing strip. There are also provided 2 wooden boxes for carrying spare parts, tools, accessories, etc.

37-MILLIMETER 1-POUNDER GUN CARRIAGE MARK A, MODEL I (BETHLEHEM).

The 1-pounder semiautomatic gun and carriage was primarily intended for landing purposes, but it has been used in trench warfare and to accompany infantry troops. This equipment is well adapted to the latter uses, due to the fact that its weight is such, as to permit it to be readily transported from place to place by man power.

The gun is made of nickel steel, with the gun body and breech end being forged in one piece. The breech mechanism is of the Bethlehem semiautomatic type in which the breech is opened, the case ejected, and the firing pin cocked on counterrecoil. The block is closed by a spring which is compressed during counterrecoil and held in that position by the extractor until tripped by the insertion of another round.

The carriage is of the long recoil type and consists essentially of a cradle, pivot yoke, trail, wheels, and axle. The cradle supports the gun, forms a housing for the recoil mechanism, and is itself supported by trunnions bearing on the pivot yoke. The recoil mechanism is located above the gun and consists of a hydraulic cylinder and counterrecoil springs. No elevating and traversing mechanisms are provided as the laying can be readily accomplished by means of a shoulder guard and grip.

Open sights are furnished and a bullet proof armor plate shield affords protection for the cannoneers.

Fixed ammunition is used, and is packed for transportation in steel boxes containing 60 rounds each. A hand cart for carrying four boxes, 240 rounds, is issued, the front and lid of this cart, being bullet proof.

Weights, dimensions, and ballistics.

Length of gun.....	inches..	68.2
Length of rifling.....	do....	61.7
Number of grooves.....		12
Muzzle velocity.....	feet per second..	2,100
Maximum range.....	yards..	4,100
Weight of charge.....	pounds..	.16
Weight of projectile.....	do....	1.07
Weight of complete round.....	do....	1.5
Weight of gun and breech mechanism.....	do....	173
Breech block.....	Vertical sliding, semiautomatic..	
Recoil (constant).....	inches..	10
Weight of carriage in battery position.....	pounds..	800
Range of elevation.....	degrees..	-5 to +15
Amount of traverse.....	do....	45
Width of track.....	inches..	35
Line of sight.....	Dependent..	
Height of axis of bore.....	inches..	29
Diameter of wheels.....	do....	42

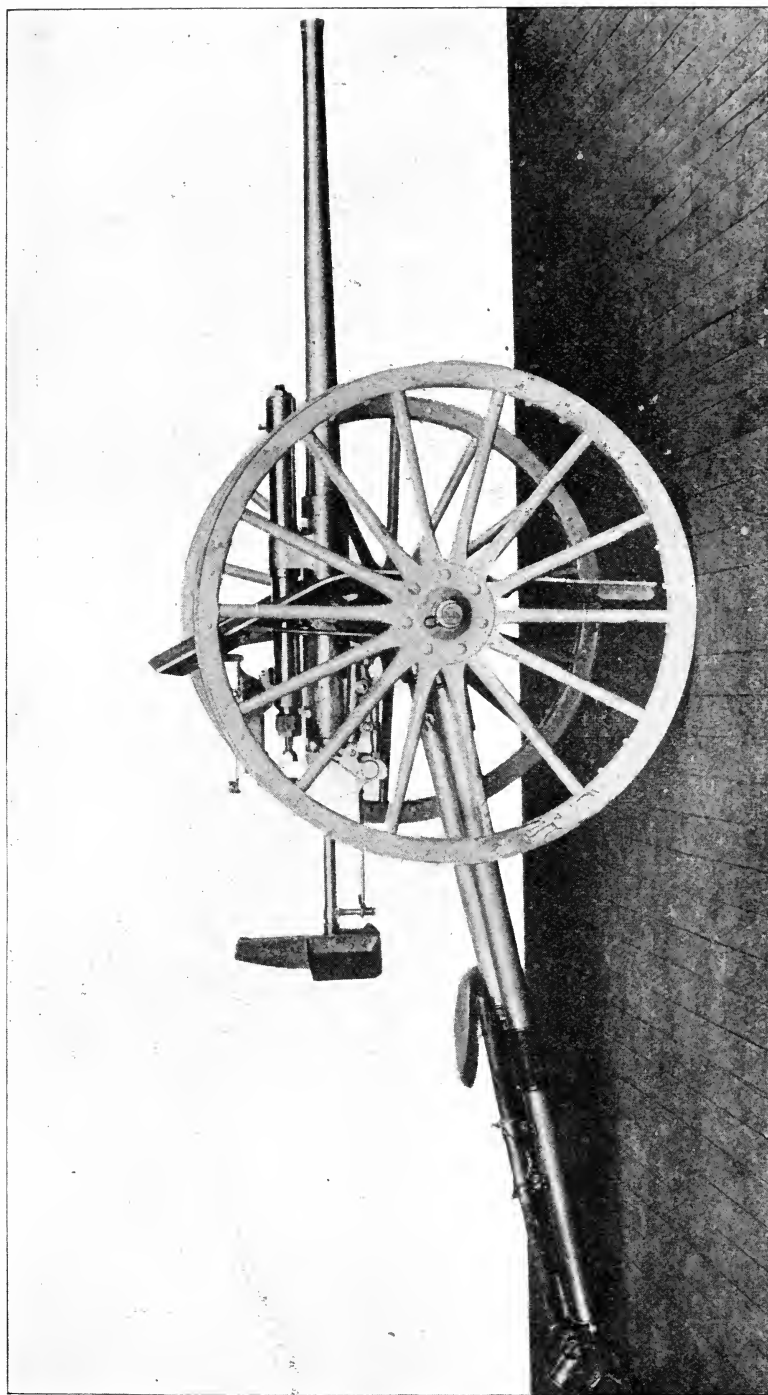

37-MILLIMETER (1-POUNDER) GUN CARRIAGE, MARK A, MODEL I (BETHLEHEM).

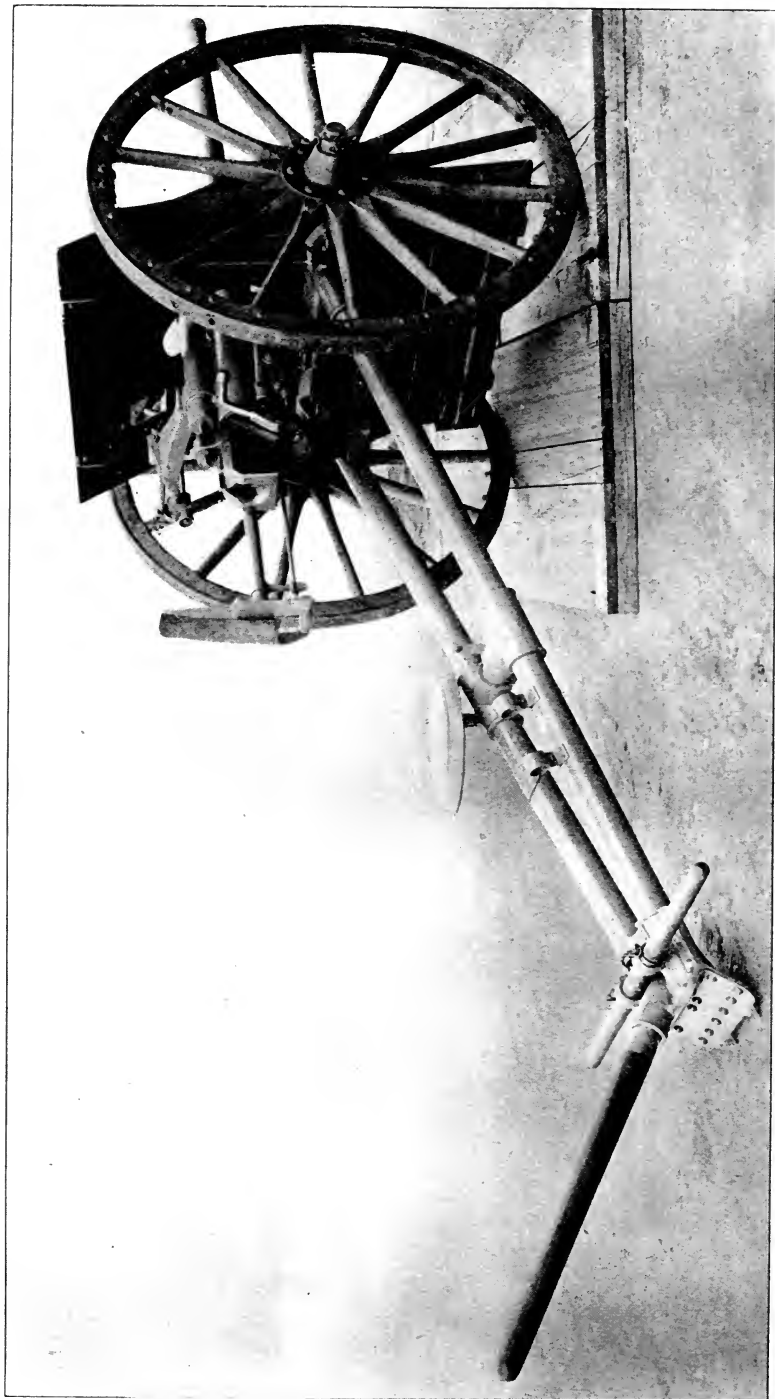

37-MILLIMETER (1-POUNDER) GUN CARRIAGE, MARK A, MODEL I (BETHLEHEM).

2.95-INCH VICKERS-MAXIM MOUNTAIN GUN MATÉRIEL.

WITH PACK OUTFIT.

The 2.95-inch Vickers-Maxim mountain gun matériel, is of Vickers design and American and British manufacture. This matériel is intended for transportation by pack animals; for this reason it is a light, compact weapon, separating very quickly and easily into four loads for packing.

The cradle is carried as one load, the wheels and axles as another, the trail another, and the gun as the fourth. Four other pack animals carry the pioneer tools, blacksmith's tools, supply chest, and signal tools, respectively. Additional pack animals are employed to carry the ammunition for the battery. Suitable pack frames with all the necessary attachments are provided for holding the load compactly and in proper place on the animal.

Weights, dimensions, and ballistics.

Caliber.....	inches..	2. 953
Length of gun.....	do....	35. 85
Weight of gun, including breech mechanism.....	pounds..	236
Rifling uniform, 1 turn in 25 calibers, right-hand twist.		
Weight of projectile.....	do....	12½
Weight of powder charge.....	ounces..	8
Muzzle velocity.....	feet per second	920
Maximum range.....	yards..	4, 825
Length of recoil of gun.....	inches..	14
Height of axis of gun above ground.....	do....	26
Maximum angle of elevation.....	degrees..	27
Maximum angle of depression.....	do....	10
Amount of traverse of gun on carriage.....	do....	0
Diameter of wheels.....	inches..	36
Width of track.....	do....	32
Weight of carriage only.....	pounds..	595
Weight of gun and carriage.....	do....	830

The gun barrel is a one-piece steel forging, cylindrical in form. On either side of the breech end two lugs are provided to which the piston rods are secured when the gun is mounted in the cradle. Forward of these lugs is a finished surface of uniform diameter which constitutes a bearing for the gun. This surface is supplemented at the forward end of the gun by two collars of equal diameter, thereby insuring a firm bearing for the gun in the cradle, either in recoil or in battery. At the bottom of the barrel is a guide which slides in a

corresponding groove in the cradle, thus keeping the gun in proper position and preventing it from turning when in action.

The breech mechanism is of the interrupted-screw type. A handle which swings from left to right turns and swings the block clear with

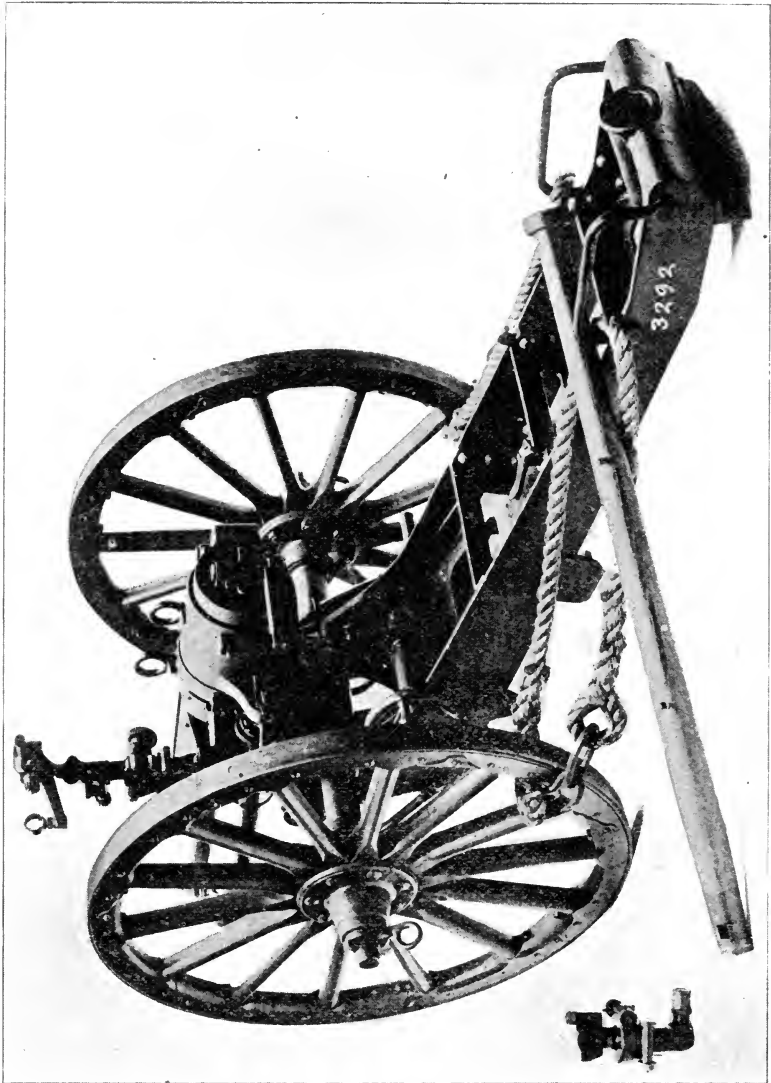

2.95-INCH VICKERS-MAXIM MOUNTAIN GUN, IN FIRING POSITION.

one motion. The firing pin is operated by means of a trigger which is pulled by the firing lanyard. A safety device is incorporated to prevent firing when the breech is not closed. The breech is equipped with an extractor which ejects the empty cartridge case after firing.

The recoil mechanism is of the hydrospring type. It is known as the short-recoil type in which the gun is permitted a length of recoil upon the carriage, sufficient to diminish the movement of the carriage on the ground but not sufficient to render the carriage stable. To

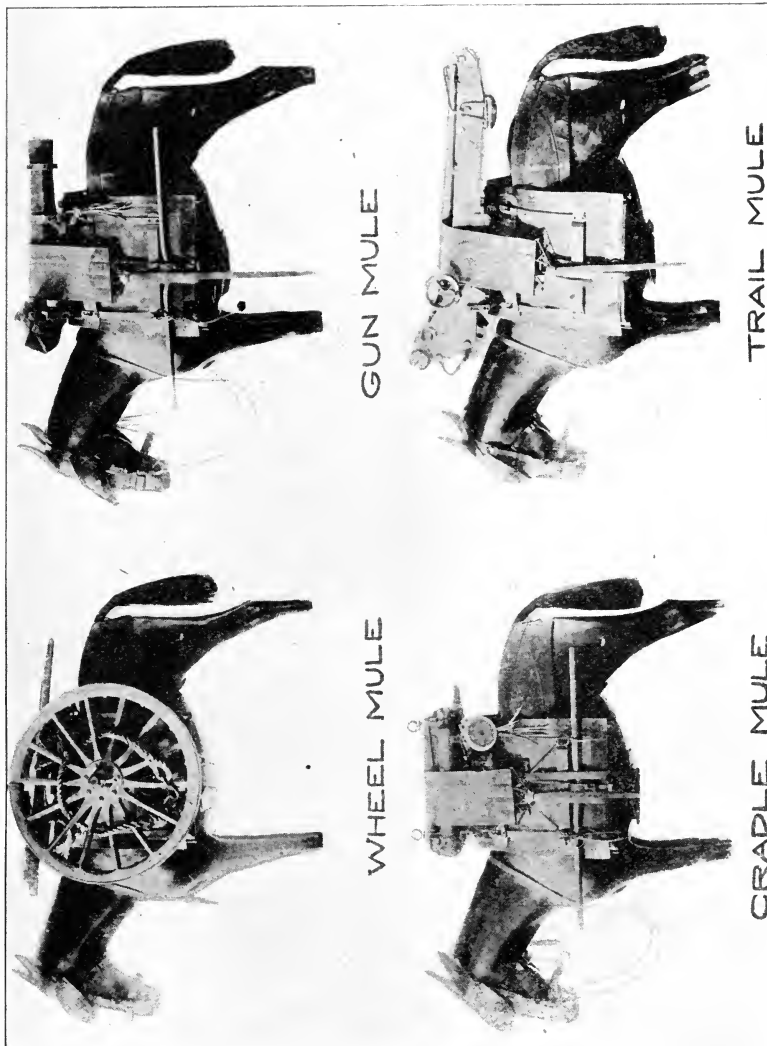

2.95-INCH VICKERS-MAXIM MOUNTAIN GUN, SHOWING PACK OUTFIT ON MULE BACK.

retard the movement of the carriage on the ground the wheels are locked by means of "brake ropes," which lock the wheels to the trail.

Two buffer cylinders, one on each side of the gun, are bored in the cradle casting. They contain both the recoil and counterrecoil mechanism. The cylinders are connected at the rear by a by-pass which keeps the oil pressure equal in the two cylinders. Throttling

is obtained by grooves of varying width in the cylinder liners. The piston rods are attached to the gun by means of interrupted screws, which permit quick removal for transportation.

The *counterrecoil mechanism* consists merely of springs wound around the piston rods, which are compressed on firing and which return the gun into battery.

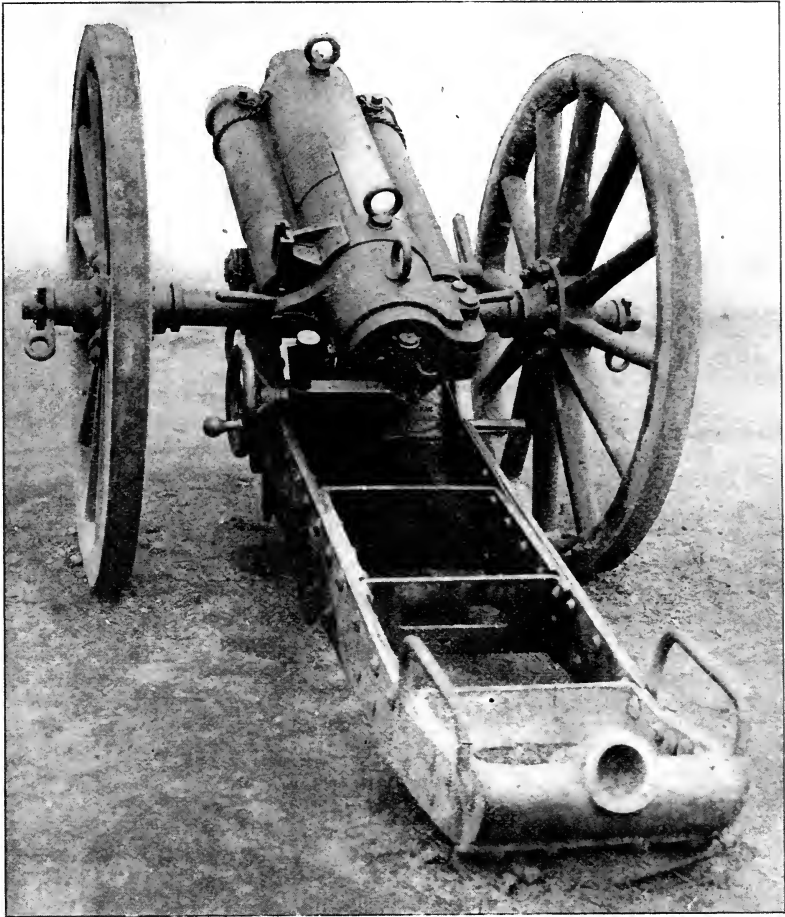

REAR VIEW OF CARRIAGE.

The *cradle* is a bronze casting comprising three parallel cylinders. The central cylinder supports the gun from the breech to within a few inches of the muzzle. The other two, as before stated, accommodate the recoil mechanism. In place of trunnions there are two lugs underneath the cradle through which passes the cradle axis bolt, by means of which the cradle is secured to the trail. This bolt is provided with a handle and suitable catch for quick removal when disassembling for packing. The cradle also carries the sight bracket

and has a plane surface on top, on which the gunner's quadrant may be used.

The elevating gear consists of a quadrant with a worm wheel segment thereon operated through suitable gearing by a handwheel on the left side of the trail. A bolt for quick release of the elevating

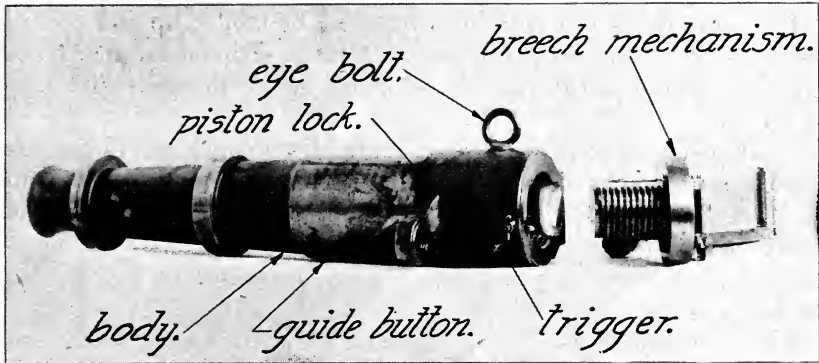

DETAILED VIEW OF GUN.

mechanism from the cradle is provided. Elevations from 10 degrees depression to 27 degrees elevation may be obtained.

No traversing mechanism is provided, and transverse must therefore be obtained by swinging the trail.

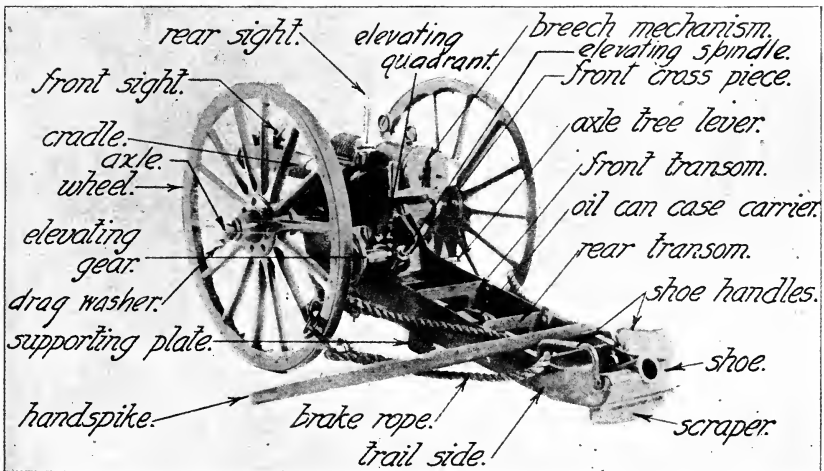

SIDE VIEW OF CARRIAGE IN BATTERY.

The trail consists of two steel side plates connected by crosspieces and transoms. The front crosspiece contains bearings for the axle, cradle axis bolt, and elevating gear. A shoe at the rear end of the trail is fitted with a "scraper," which in reality is a short spade. It is also provided with a socket for the handspike.

The axle is a solid cylindrical bar with flats cut on two sides for securing it in the front crosspiece of the trail. It is quickly removable for packing and is carried on the same pack animal as the wheels. The wheels are 36 inches in diameter and are steel tired.

Sighting is accomplished by means of the sight, model of 1912, combined with either an open sight or the panoramic sight.

The sight shank is a steel arc which can be moved up and down in elevation by means of a scroll gear. A range strip on the rear face of the arc is graduated in 50-yard divisions up to the maximum range of the piece.

Combined with the sight is a graduated level which serves the same purpose as the range quadrant used on the 3-inch equipment and other matériel of that type. By this means the piece is laid for elevation.

The sight is mounted on the left side of the cradle. By having the quadrant level and sight thus combined one man can lay for both elevation and direction.

The ammunition used is of the fixed type, consisting of the steel high explosive and shrapnel shells, each weighing $12\frac{1}{2}$ pounds. Each animal carries two chests containing five rounds each.

75-MILLIMETER GUN MATÉRIEL, MODEL 1916.

The United States model 1916, 75-millimeter field gun is an adaptation from the United States 3-inch field gun, model 1916, arranged with a split trail and having greater traverse and greater elevation than either the French or British models of this caliber.

The 75-millimeter field gun constitutes the light artillery or rapid mobile field artillery of the Army. The caliber of the piece is about as large as ready horse-drawn mobility will permit. The caliber is

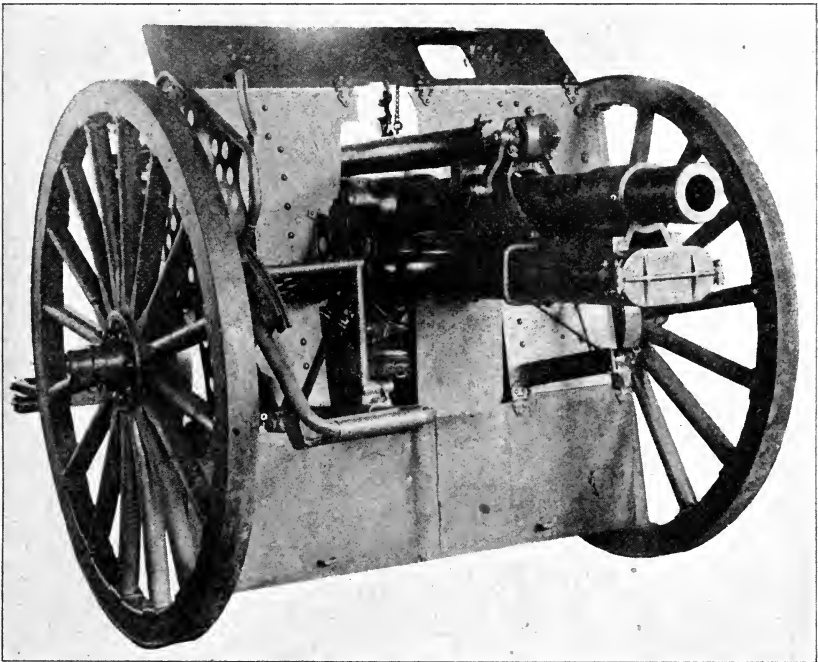

FRONT VIEW OF CARRIAGE.

equivalent to 2.95 inches, and was adopted by the French and by the Italians, while the United States had adopted the caliber of 3-inch and Great Britain a caliber of 3.3-inch, which is the caliber of their 18-pounder. The German caliber was 77 millimeters, equivalent to 3.03 inches. The points of excellence obtained from these types are accuracy, long range, rapidity of fire, ease of transportation, and smooth and reliable functioning.

As the range depends not only on the power of the gun and on the design of the ammunition but on the elevation provided for, and

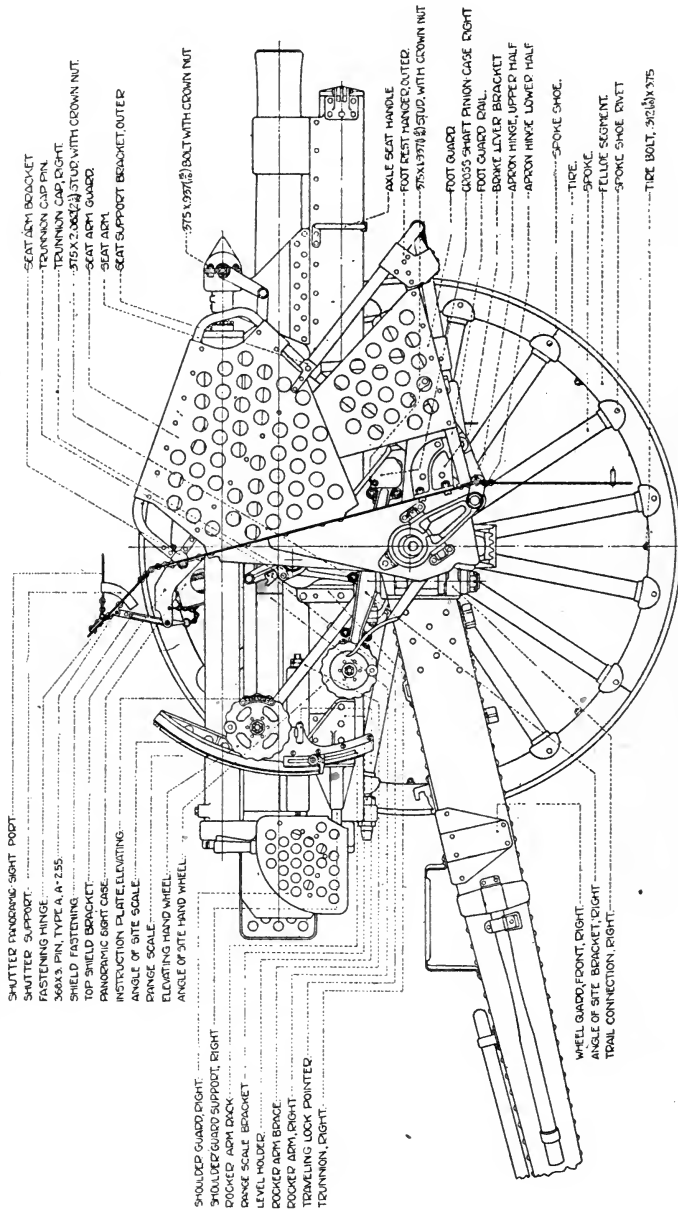

75 MM. GUN CARRIAGE, MODEL OF 1916.
 RIGHT ELEVATION

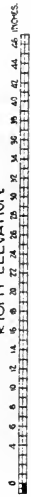

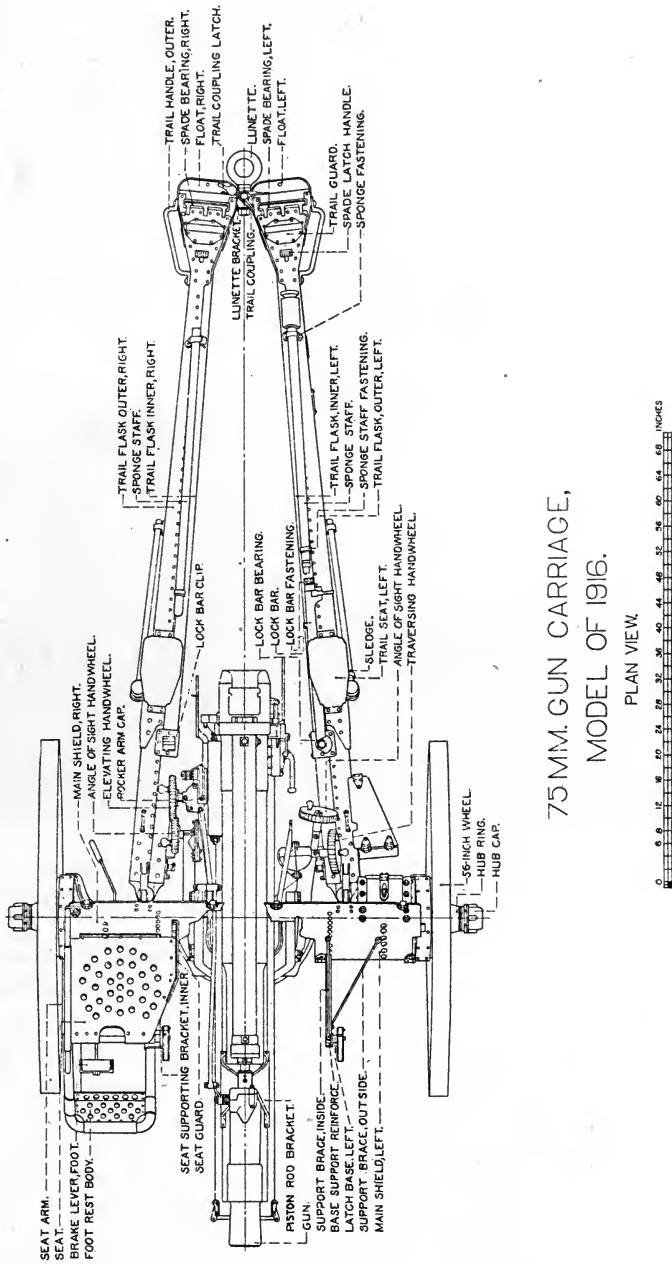

75 MM. GUN CARRIAGE,
MODEL OF 1916.

PLAN VIEW.

as the horizontal arc which could be covered by a gun with a single setting of its trail is governed by the permissible traverse, great attention was given to the mechanical features covering the vertical and horizontal limits of the gun laying, as well as to the smooth and reliable functioning of the piece. Of the above models, the French model is credited with functioning most perfectly, but the United States completed a new carriage which permits very high elevation of the gun and wide traverse. Due to the permissible elevation, the American piece outranges the French, although the French gun has a greater muzzle velocity.

Roughly, the weight of the piece, including the carriage and limber, is about 4,600 pounds, which in general corresponds with the horse-drawn draft limitation over rough ground of 765 pounds per animal,

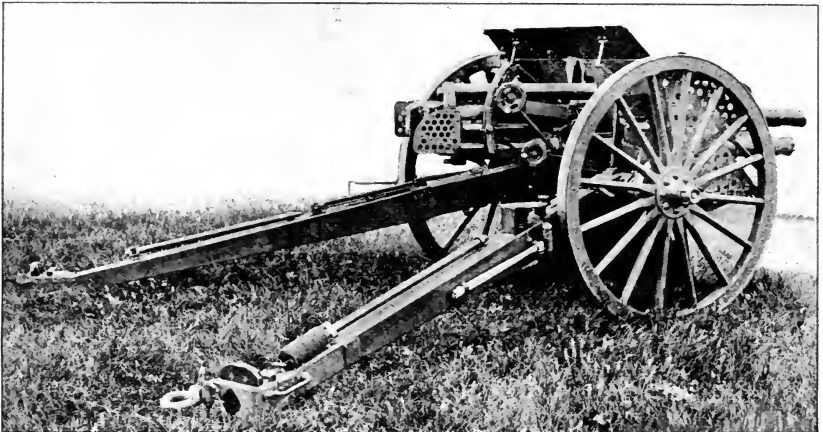

REAR VIEW OF CARRIAGE.

calling for six horses to the piece, although four horses are frequently employed over level or hard ground.

The introduction of motor tractors has altered the draft problem, but there still remains the question of facility in handling the piece by man power after battery position has been reached. As illustrative of this it may be mentioned that the weight at the end of a 75-millimeter gun carriage trail is in the vicinity of only 100 pounds. The trails can be readily unlimbered and spaded into position or its position changed by man power within a few moments, while to unlimber and spade into position or to change the position of the trail of a 155-millimeter gun requires the use of jacks and a considerable expenditure of time.

Rapidity in moving a fieldpiece from point to point, where railroad transportation is not available, is not entirely a matter of the speed of the tractor, for likelihood of damage to the matériel when transported at high speed on its own wheels must also be considered.

The dimensions and weight of the 75-millimeter piece permit of its being placed on a rubber-tired trailer, which allows of its being transported at high speed behind a motor vehicle.

The movement of the light artillery is of utmost importance, and the 75-millimeter field gun may be considered as a gun of first rank, for it constituted the light artillery of the military powers. This weapon is accurate, has a range up to 6 or 7 miles, is suitable for the projection of high explosives, shrapnel, incendiary, smoke, asphyxiating, tear, tracer, illuminating, terrorizing, and chain projectiles, and is adaptable for barrage fire, destruction of personnel, tearing away of wire entanglements, destruction of fair-sized obstacles, and to some extent the destruction or protection of lines of communication. The indications are that a slightly larger caliber will supplant this caliber in order to obtain longer range and greater destructive force and either motorization or direct mounting on self-propelled caterpillars may affect the

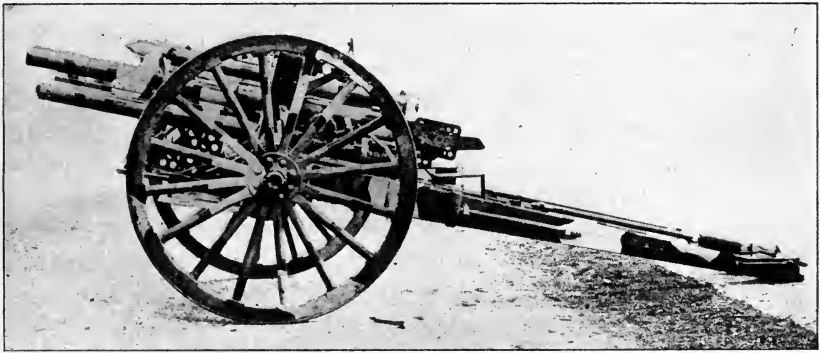

LEFT SIDE VIEW OF CARRIAGE.

adoption of a new caliber, for mobility and rapidity and ease of handling are features of importance in this branch of the field artillery.

Weights, dimensions, and ballistics.

Weight of gun and breech mechanism.....	pounds..	749
Length of gun.....	inches..	90.9
Caliber.....	millimeters..	75
Length of bore.....	inches..	84
Length, calibers.....		28
Rifling, right hand twist, zero turns from origin to point 2.89 inches from origin; from this point increases one turn in 119 calibers to one turn in 25.4 calibers at a point 9.72 inches from muzzle. Uniform from this point to end of muzzle.		
Number of grooves.....		24
Muzzle velocity:		
Shrapnel.....	feet per second..	1,693
Shell (short fuze).....	do....	1,900
Shell (long fuze).....	do....	1,876

Maximum range:

Shrapnel (Mark IV shell).....	yards..	9, 650
Shell (short fuze).....	do....	12, 360
Shell (long fuze).....	do....	11, 155
Weight of carriage, complete (without gun).....	pounds..	2, 280
Weight of gun and carriage, fully equipped.....	do....	3, 045
Diameter of wheels.....	inches..	56
Width of track.....	do....	60
Length of recoil of gun on carriage (variable).....	do....	18-46
Height of axis from ground.....	do....	41. 625
Maximum angle of elevation.....	degrees..	53
Maximum angle of depression.....	do....	7
Maximum traverse, each side of center.....	mils..	400
Maximum angle of elevation with angle of site handwheel.....	degrees..	11
Maximum angle of depression with angle of site handwheel.....	do....	7

75-MILLIMETER GUN AND CARRIAGE, MODEL OF 1916 (AMERICAN).

The gun is of the built-up construction and consists of a tube, jacket, locking hoop, breech hoop, and clip. There are six slightly varying types of this gun, but the variations deal only with the manner of attachment of the jacket and locking hoop and do not affect the general dimensions. The gun is guided in recoil by two flanges on the lower side of the jacket. A lug on top near the forward end of the jacket containing a T-slot, holds the forward end of the recoil cylinder.

A short hoop or clip is shrunk on the tube near the muzzle and has on its under side two lugs which form guides for the gun on the cradle. Provision has been made to prevent dust from entering between the surfaces of the guides and their bearing surfaces on the cradle.

The breech ring, which screws to the rear end of the jacket, forms a housing for the breech block which slides up and down with the action of a wedge. The ring carries at the top a lug to which the hydraulic recoil cylinder is secured, and at the bottom another to which the two spring piston rods are attached.

The breech block is of the drop-block type and operates semi-automatically, in that the breech closes automatically when a round of ammunition is inserted. It is opened by pulling back a handle on the right side of the breech, which not only slides the breech block out of place but operates the extractor, thus ejecting the empty cartridge case. When a round is inserted smartly into the breech, its rim strikes against the lips of the extractor causing the mechanism to close under the action of the closing spring. The cartridge primer is fired from the left side of the carriage by a continuous-pull firing mechanism. The firing pin is cocked and fired by one continuous backward motion of the firing handle.

The carriage is of the split-trail type which means that the trail is made up of two halves, each being hinged to the axle near the wheels and capable of being spread out at a wide angle or brought together at the spade ends and locked for traveling. This feature permits greater elevation and traverse than the ordinary type of trail and reduces the necessity of shifting the trail when changes in deflection of 50 mils or more are desired.

A seat is provided on each half of the trail, the one on the left for the gunner who operates the sights, the traversing and angle of site handwheels, and fires the piece, and the one on the right for a cannoneer who sets off the range and angle of site and operates the breech mechanism.

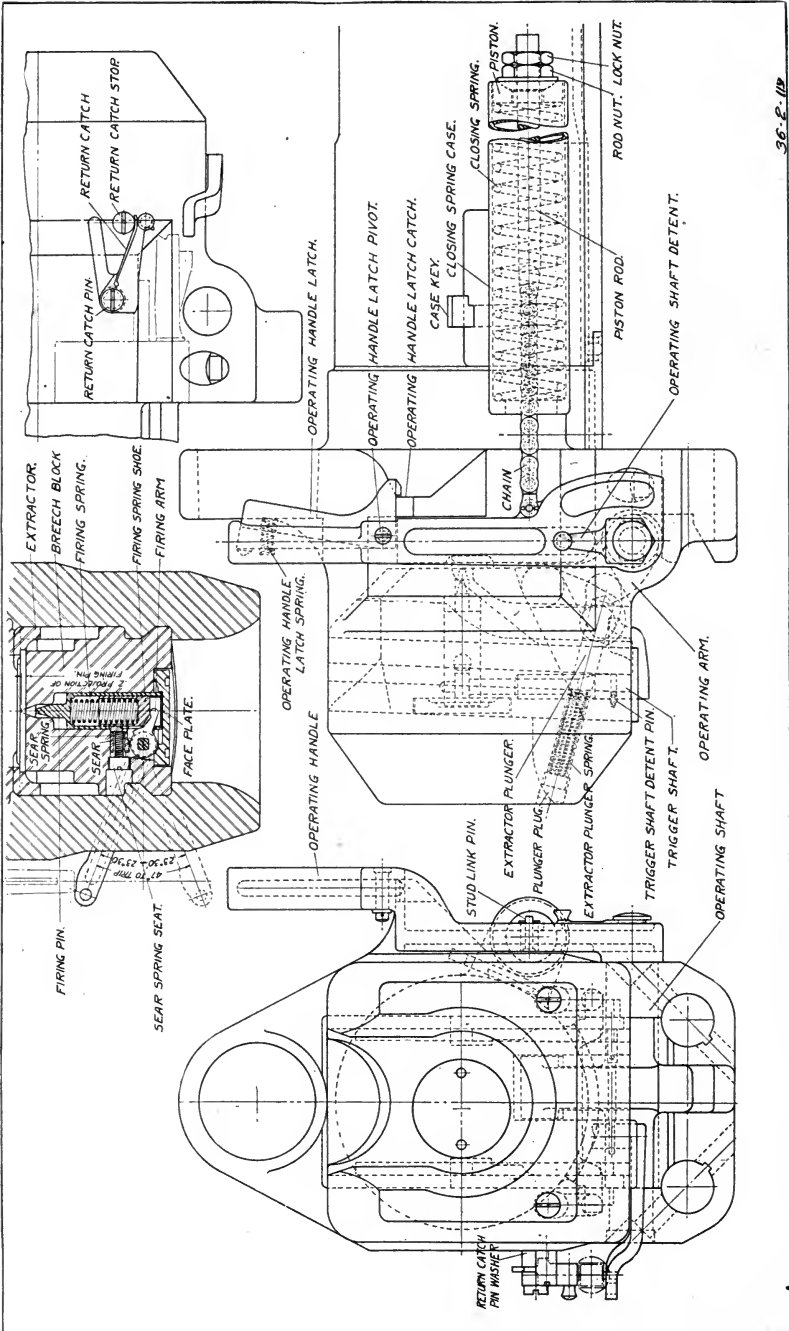

The recoil mechanism is of the hydro-spring variable recoil type consisting of one hydraulic and two spring cylinders which comprise the recoil and counterrecoil mechanisms. On account of the high angles of elevation at which this gun can be fired, it was necessary to design a variable recoil system by means of which the length of recoil of the gun would be automatically lessened, the higher the muzzle is elevated. This is accomplished by means of a valve turning in the cylinder and shutting off or opening a number of holes, proportional to the elevation, thus making the resistance to the passage of the oil greater or less.

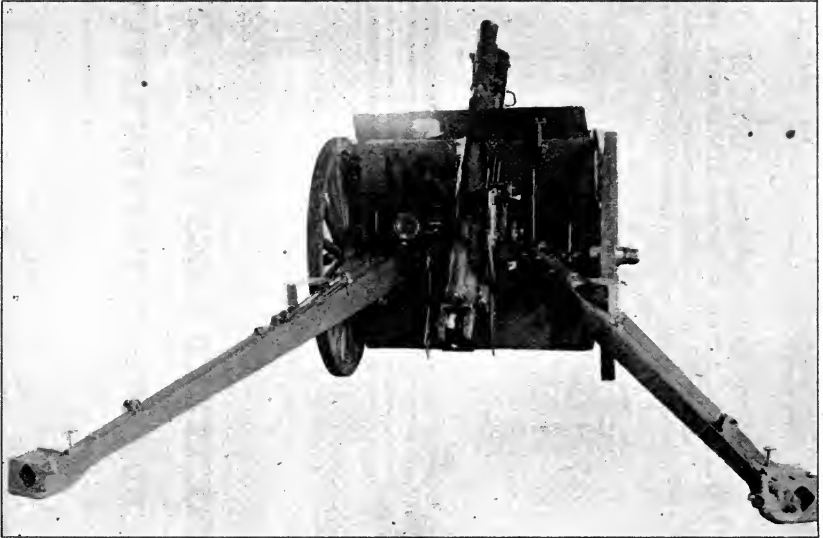

GUN AT MAXIMUM ELEVATION.

The angle of sight mechanism consists principally of a rocker which is moved by two handwheels, one on each side of the gun. Movement of the mechanism causes the gun, cradle, elevating mechanism, and sights to move also, they being connected to the rocker. The handwheel on the left or gunner's side is used when laying for direct fire, or in other words, when site is set independent of range. The angle of sight scale is graduated in mils. All settings on the angle of sight scale are set off above or below the 300-mil graduation, this being the normal setting when the axis of the bore and the target are in the same horizontal plane.

The elevating mechanism used in setting the range is mounted on the rocker, and therefore independent of the angle of sight mechanism, the gun and cradle only being moved upon operation of the handwheel. The range scale is graduated in meters.

Band brakes are used on this carriage and are operated by a hand lever in rear of the shield when in battery position and by a lever from the axle seat when in traveling position.

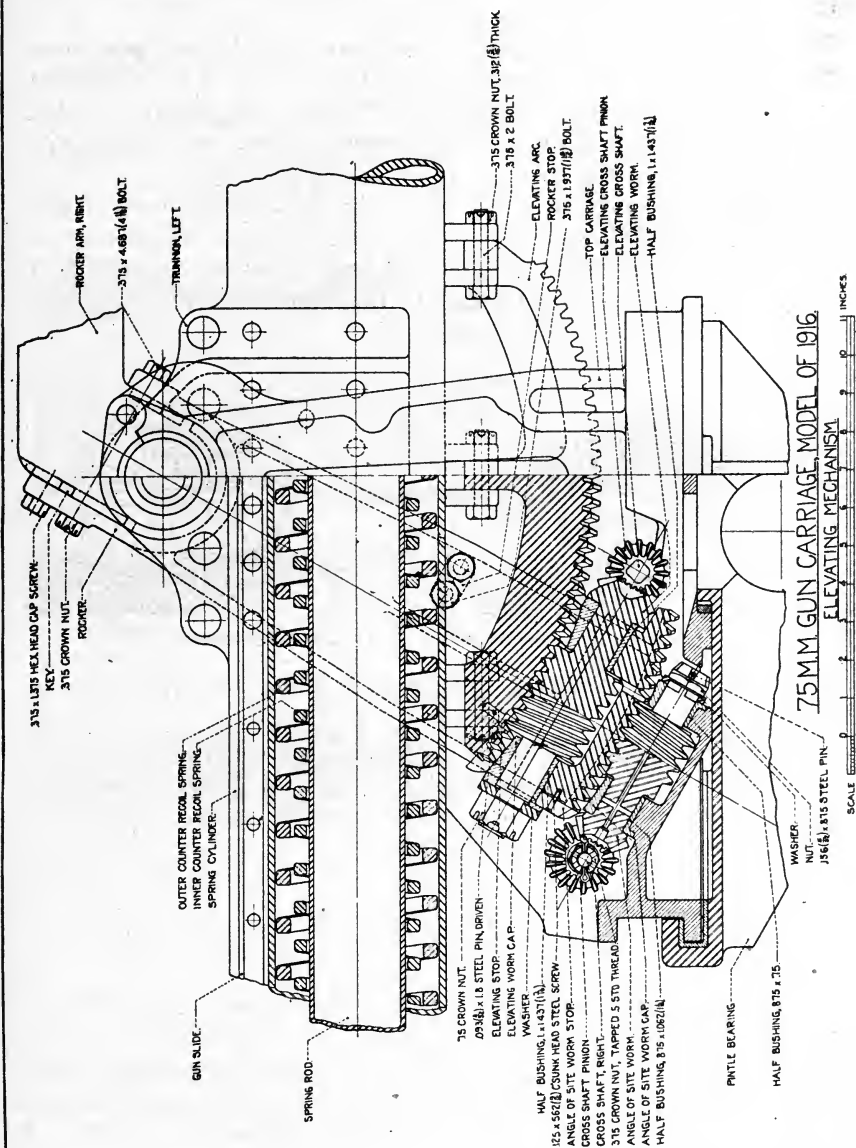

The gunner and cannoneers are protected by the customary shields and apron.

The sight used is of the model of 1916 type, which provides a support for the panoramic sight and the peep sight.

Wooden wheels, 56 inches in diameter, with steel hubs and tires, are used, the tires being 3 inches in width. These wheels are interchangeable with those of the caissons and limbers.

Fixed ammunition is used in the 75-millimeter field guns and is made up of either common shrapnel or common steel shell. Shrapnel rounds are issued with the projectiles filled and fuzed; the shell rounds are issued filled but not fuzed and contain an adapter with booster charge.

The projectiles average in weight: Shrapnel, 16 pounds, fuzed; shell, 12.3 pounds, fuzed. The components of one round are the cartridge case with primer, powder charge, projectile, and fuze in shrapnel, and adapter and booster in the shell. Weight of powder charge is approximately 1.5 pounds.

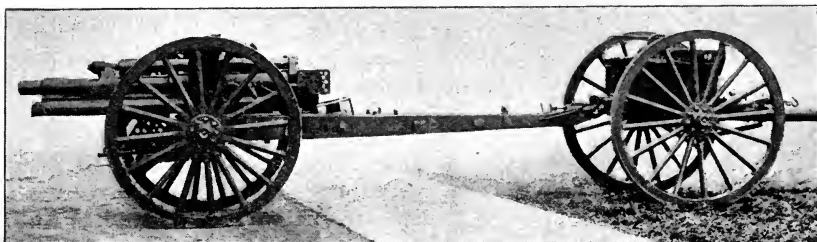

CARRIAGE AND LIMBER IN TRAVELING POSITION.

A battery of 75-millimeter gun carriages, model of 1916, is accompanied by the following vehicles:

75-millimeter gun carriage limber, model of 1918.

75-millimeter gun caisson, model of 1918.

75-millimeter gun caisson limber, model of 1918.

Forge limber, model of 1902 M1.

Store limber, model of 1902 M1.

Battery and store wagon, model of 1917.

Battery reel, model of 1917.¹

Reel, model of 1909 M1.

Cart, model of 1918.¹

The above gun carriage was originally the 3-inch gun carriage, model of 1913, which was later called the 3-inch gun carriage, model of 1916. The gun was afterwards modified to caliber 75 millimeters, as was the 3.3-inch British, thereby permitting interchangeability of ammunition with the French guns.

¹ For horse batteries the battery reel, model of 1917, is issued. For motorized batteries the reel, model of 1909 M1 with the cart, model of 1918, is issued in lieu of the battery reel, model of 1917.

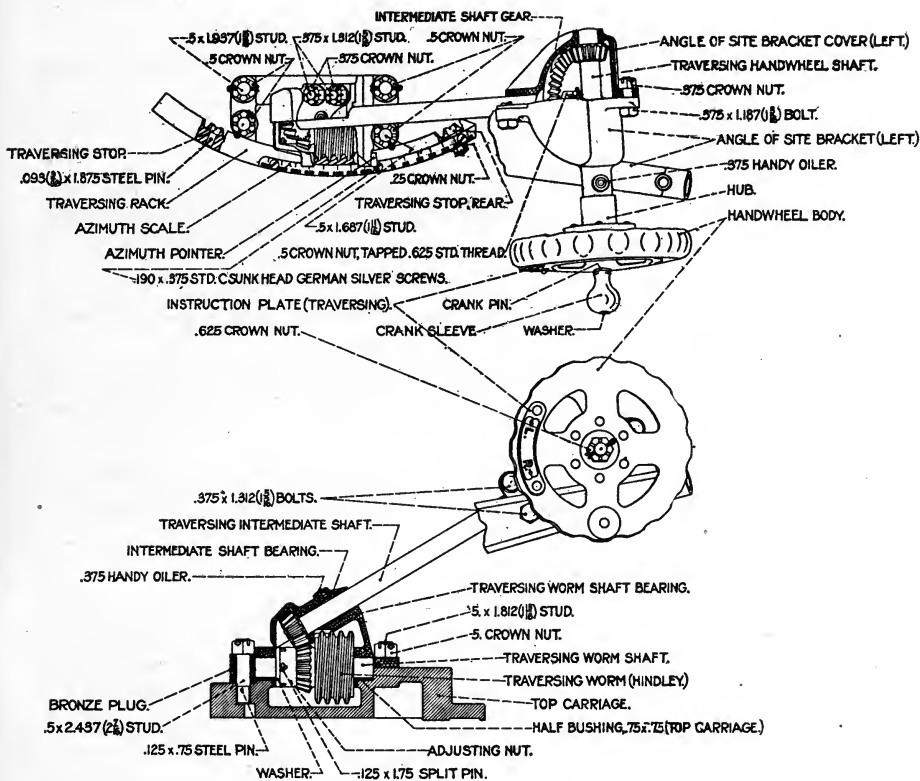

75 MM. GUN CARRIAGE, MODEL OF 1916.

TRAVERSING MECHANISM.

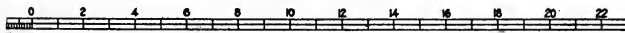

75-MILLIMETER GUN MATÉRIEL, MODEL OF 1916 MI.

There will soon be issued to the service a number of model 1916 75-millimeter gun carriages, redesigned to mount a St. Chamond hydropneumatic recoil mechanism in place of the hydrospring type, and a standard 75-millimeter gun modified and fitted with a counterweight. The new matériel will be known as the 75-millimeter gun matériel, model of 1916 MI.

The St. Chamond recoil mechanism as adopted for these carriages was developed during the war in 1917 by Col. Rimailho, of the French Army. This mechanism, of the hydropneumatic type, is durable and smooth in operation. The use of small cradle forgings was made possible by the introduction of high pressures in the recuperator and recoil cylinders. In order to hold these pressures, it was necessary to develop suitable packing, and the success of this recoil system is largely due to the design of these packings.

The St. Chamond recoil mechanism consists of three cylinders, the middle one being the recoil cylinder, the right cylinder having an air reservoir at its forward end, and an oil reservoir at its rear end; the left cylinder, known as the recuperator cylinder, has at its forward end an air space, and at its rear end a floating piston and regulator for controlling the length of recoil.

The recoiling parts are held in battery by the reaction of the air on the floating piston transmitted through the liquid against a leak-tight recoil piston. In recoil the gun moves to the rear, carrying with it the recoil piston (middle cylinder). The energy of recoil is absorbed by the throttling of the oil through a spring-controlled orifice in the regulator valve.

An opening is provided between the recoil and the recuperator cylinders to house the regulator valve. During recoil, the pressure in the recoil cylinder opens the regulator valve, the movement of which is controlled by a helical spring and Belleville springs. The oil passing through the orifice controlled by this valve moves the floating piston forward against the air pressure, thereby storing up energy to return the gun from the recoiled position to its position in battery. The valve in the counterrecoil orifice remains closed during recoil.

The throttling during recoil is controlled by the regulator valve, which consists of two parts, an upper stem and a lower valve stem. The lower valve stem is seated on a circular seat at the entrance channel to the valve. As the valve lifts, the throttling area becomes

the vertical circumferential area between the valve and its seat. In long recoil the movement of the valve is controlled by a spiral spring which reacts on the lower valve stem. The upper stem rests in a valve housing and has Belleville springs reacting on the stem only. To move the upper valve stem, the whole housing is lowered automatically by a cam operated by the elevation of the cradle. At short recoil, the upper stem of the regulator is brought down by the cam until its lower surface is in contact with the top surface of the lower valve stem in order to control the throttling of the valve.

The regulator valve is closed during the counterrecoil movement. The oil flow during counterrecoil is different from that during recoil, the counterrecoil flow path being through a small channel beginning at the inside end of the buffer chamber in the recuperator cylinder and finally emptying into the recoil cylinder. The throttling during counterrecoil takes place through a constant orifice located at the beginning of the counterrecoil channel. The tapering buffer rod on the floating piston in the recuperator causes additional throttling through the small annular area between the buffer chamber and buffer rod of the floating piston, which brings the recoiling parts to rest without shock.

75-MILLIMETER GUN MATÉRIEL MODEL OF 1897 M1 (FRENCH).

The French 75-millimeter field gun adopted for the service of the United States dates back to 1897, when it was perfected by the French Army.

The French model 1897 field gun has fired, on test, as high as 30 shots in a minute, and it is understood that the American model 1916 equaled this rate; likewise, a St. Chamond gun with interrupted screw-type breech on the special St. Chamond recuperator. Apart from the personnel service to the piece, the length of time which either gun could maintain this rate of fire, or any other rapid rate of fire, is perhaps not definitely determined. As to whether or not such length of time would be limited by the heating of the gun or by the heating of the recoil mechanism is likewise perhaps not definitely determined.

Rapidity of firing is of vital importance, for it is self-evident that under certain conditions a gun which can fire twice as many shots per minute as some other gun is, for the moment, equivalent to two guns of the second class. Rapidity of firing action is dependent upon the arrangements involved for the sighting, maintaining of the gun on its range, loading, firing, time of recoil and return of the gun to battery position, opening of the breech, and ejection of the empty cartridge case.

For artillery of position a great part of the enormous energy required to start the projectile on its way may be absorbed by a heavy foundation furnished as a mounting for the piece. An efficient recoil mechanism is, however, of vital importance in connection with light artillery for field service, owing to the essentially light weight of the carriage on which the gun is mounted, to permit of its ready mobility.

The recoil mechanism not only absorbs the greater part of the recoil energy of the gun, but it returns the gun to the battery or firing position, and to be efficient it must be able to perform these two functions quickly, smoothly, surely, and continuously. The word "surely" is used in the sense of firmly and without shock, and of being reliable. The recoil mechanism not only takes up the recoil but it forces the gun all the way back into battery, or to a position within the variation which the design permits, under all conditions of elevation and heating.

The general theory of hydropneumatic recoil mechanism is not new. In its relation to light artillery its most notable exemplification in battle has appeared in the Puteaux Arsenal type of the French piece. Its virtues have been widely heralded and every effort has been made to keep its construction secret. Its several parts were



LEFT REAR VIEW OF 75-MILLIMETER GUN CARRIAGE, MODEL OF 1897 MI (FRENCH).

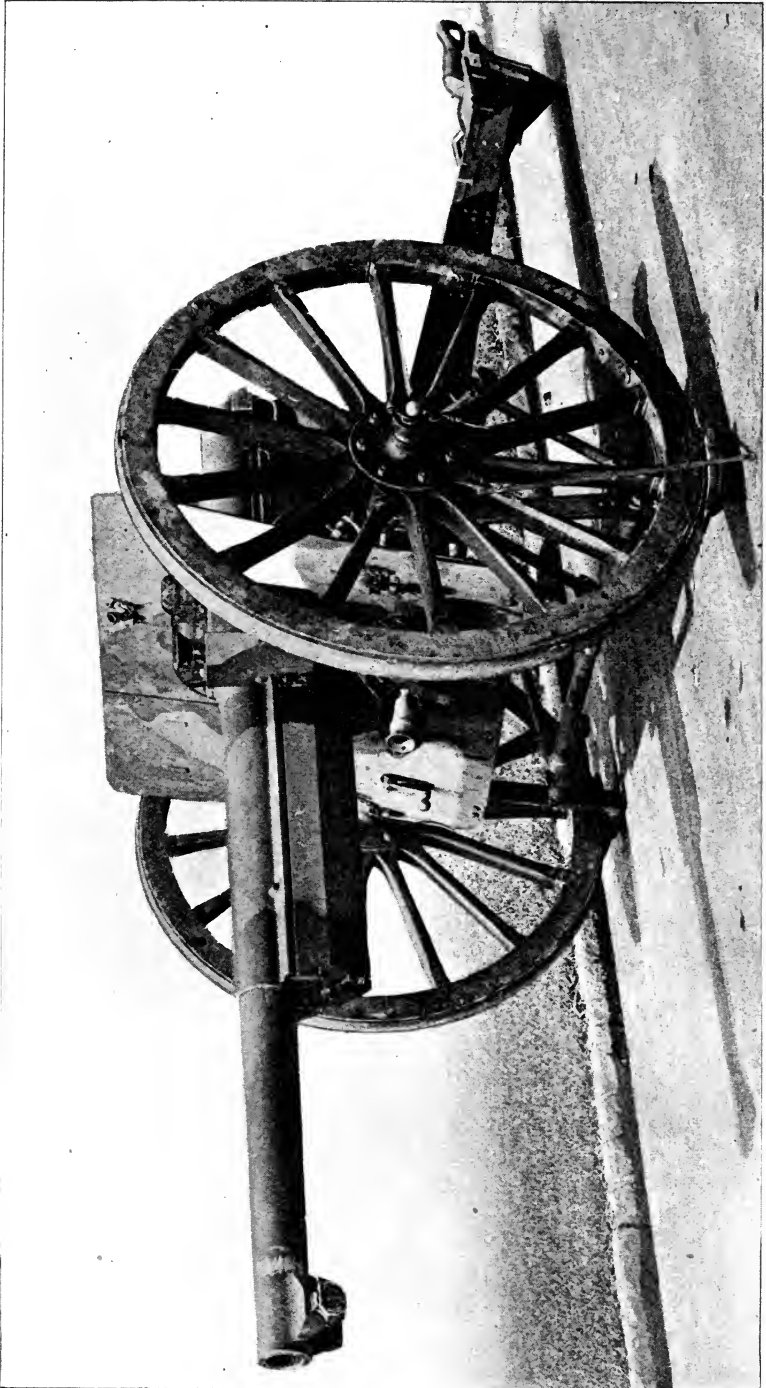

FRONT VIEW OF 75-MILLIMETER GUN CARRIAGE, MODEL OF 1897 M1 (FRENCH).

manufactured at different points in France and these were assembled in a small room at the Puteaux Arsenal, and but few persons were admitted to this room. In the agreement, to manufacture of the complete recuperator in the United States, it was stipulated that the greatest secrecy should be maintained with reference to its design, manufacture, and assembly.

There is a difference between land and naval warfare, in this respect: In a duel between two large fighting ships of equal speed to insure their remaining in contact, the one with the heavy, long-range guns has the other at its mercy, as it can destroy both its opponent's base and at the same time its opponent's personnel by sinking the opponent ship. In a land battle, the fortifications may be reduced by the long-range gun, of heavy caliber, but it is the destruction or capture of personnel which brings a war to an issue and the personnel may move to open country and open order, under which conditions the heavy, long-range gun, which is expensive to construct, slow and difficult to transport, expensive to fire, and withal short of life, no longer has a great target on which its tremendous energy may be concentrated.

Land warfare has clearly demonstrated that it is the killing and disabling of personnel or the capture of enemy troops in large numbers which far outweighs the capture of cities or of terrain which is nonproductive of raw material, in the forcing of an issue. This 75-millimeter gun was most effective in the open-country fighting, in the protection of troops and in working havoc among enemy troops and bringing in prisoners by creeping barrage laid behind an enemy formation.

Weights, dimensions, and ballistics.

Caliber.....	millimeters..	75
Total weight of gun and breech mechanism.....	pounds..	1, 015
Total length of gun.....	inches..	107. 125
Rifling, uniform, right hand, 1 turn in 25.6 calibers.		
Muzzle velocity:		
Shell (short fuze).....	feet per second..	1, 955
Shell (long fuze).....	do....	1, 930
Shrapnel.....	do....	1, 755
Maximum range:		
Shell (short fuze) (Mark IV shell).....	yards..	8, 640
Shell (long fuze).....	do....	9, 350
Shrapnel.....	do....	7, 440
Weight of complete round of ammunition:		
Shrapnel.....	pounds..	16
Shell.....	do....	12. 3
Diameter of steel tired wheels.....	inches..	52. 5
Width of track.....	do....	59. 68
Length of recoil of gun on carriage.....	do....	44. 9
Height of axis of gun from ground.....	do....	40. 4
Maximum angle of elevation.....	degrees..	19
Maximum angle of depression.....	do....	10
Total traverse of carriage on axle.....	do....	6
Weight of the carriage, complete (without gun).....	pounds..	1, 642
Weight of gun and carriage, fully equipped.....	do....	2, 657

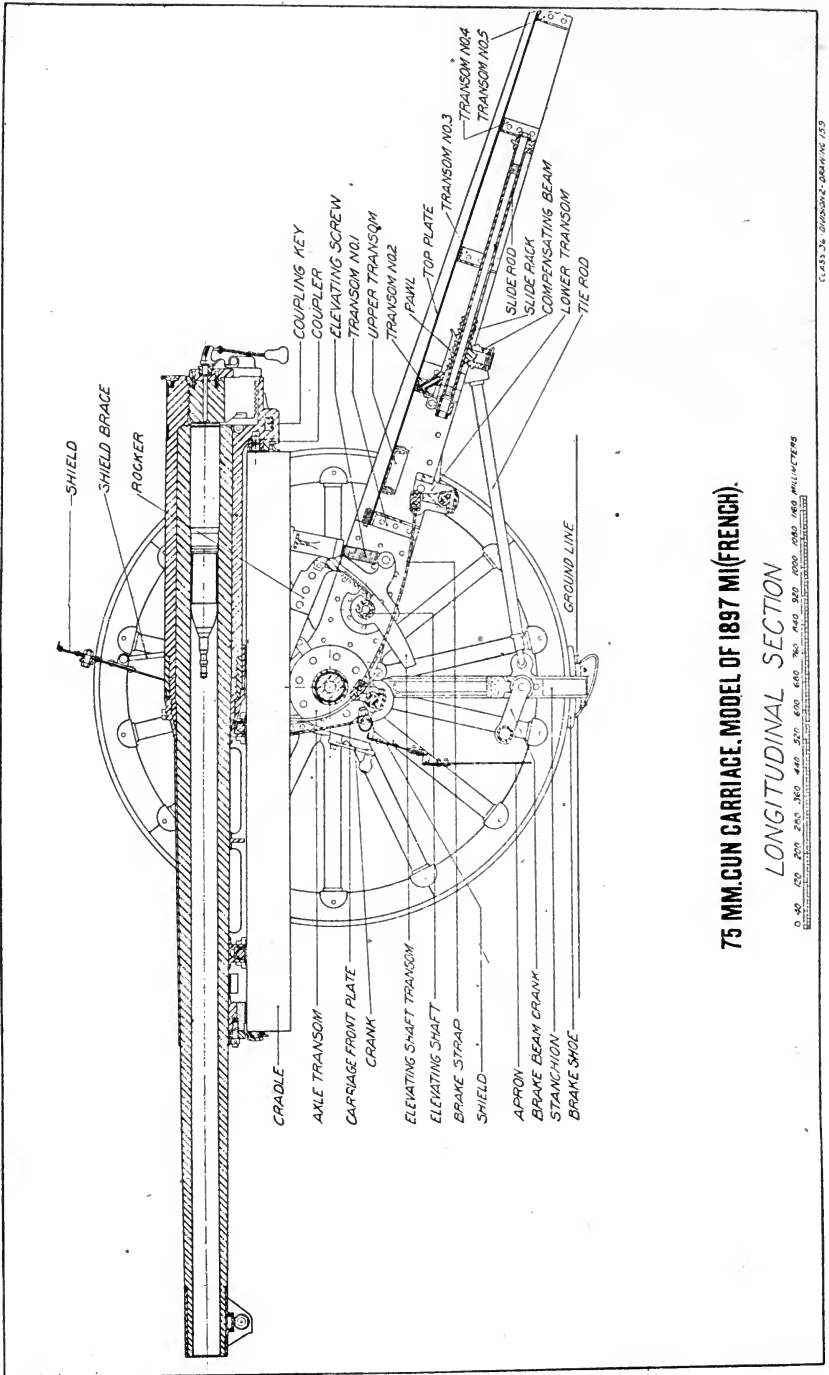

75 MM. GUN CARRIAGE, MODEL OF 1897 M (FRENCH).

LONGITUDINAL SECTION

0 45 125 205 275 355 435 515 595 675 755 835 915 995 1075 1155 1235 1315 1395 1475 1555 1635 1715 1795 1875 1955 2035 2115 2195 2275 2355 2435 2515 2595 2675 2755 2835 2915 3000

C. 433.26. 0103042. 06/11/1913

**75 M. M. FIELD GUN
MODEL OF 1897
(FRENCH)**

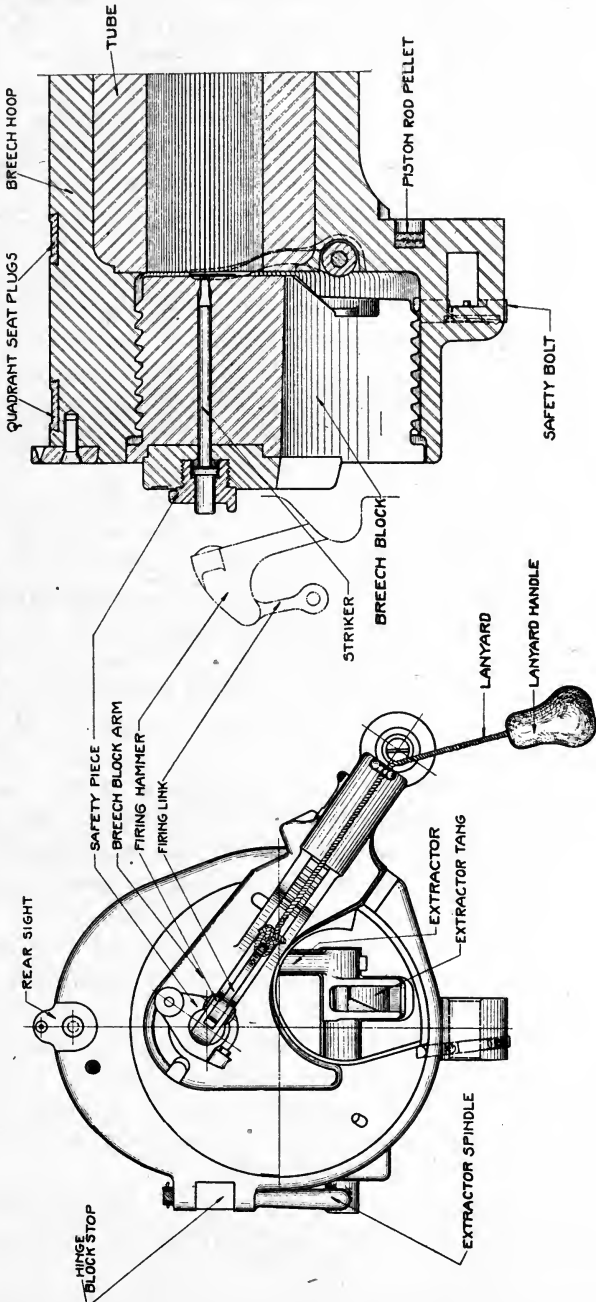

75-MILLIMETER GUN AND CARRIAGE, MODEL OF 1897, M1 (FRENCH).

The gun is of the built-up construction type, consisting mainly of a steel tube reinforced at the breech end with a breech hoop and covered in the central portion with a bronze jacket. The total length from face of breech to muzzle is slightly less than nine feet.

The recoil lug under the breech carries the coupling key, which connects the gun to the recoil mechanism. A safety pin operates between the breechblock and the coupling key, so that it is impossible to close the breech and fire the gun when it is not securely locked to the recoil mechanism of the carriage.

On the underside of the gun are inclined bronze slides which are in contact with similar slides on the recoil mechanism. Rollers are also attached to the gun, and during recoil the gun first slides on the inclined guides and then the rollers lift the weight off the slides, the remainder of the travel being on the rollers. A pair of rollers at the muzzle permit a long recoil with short guides by taking the overhanging weight when the gun is at full recoil.

The breechblock is of the Nordenfeld type, cylindrical in shape and threaded on the outside. It is opened or closed by the operating handle from the right side of the gun by the same man who sets the gun for range and fires the piece. Opening the breech automatically actuates the extractor, which in turn ejects the empty cartridge case. The round of ammunition is fired by a striker which is driven forward by a spring-actuated hammer pulled by the lanyard.

The carriage is very compact and simple, consisting of a housing around the axle, above which is the support for the cradle, and a box section trail ending with the customary spade and lunette. Seats are provided for two men, the one sitting on the right side operating the range scale mechanism, opening or closing the breech and firing the piece; the man on the left sighting the gun and operating the angle of site and traversing mechanisms.

The recoil mechanism is of the hydropneumatic, long recoil type and contains both recoil and counterrecoil mechanisms. A gage plunger is located in the rear end of the cradle which, when flush, indicates that more oil should be added until the plunger projects about $\frac{3}{8}$ inch. Oil may be added by forcing it through a valve in the side of the cradle by a hand screw filler, or by means of a portable battery pump clamped to the side of the trail and connected through the trunnions to the interior of the cradle.

The recoil mechanism is housed inside of the cradle, through which are bored an upper and lower cylinder, filled with Oleonapthe, able to communicate together by means of a passage provided for that purpose. The front part of the upper cylinder (in front of the piston) is permitted to communicate freely with the air through a

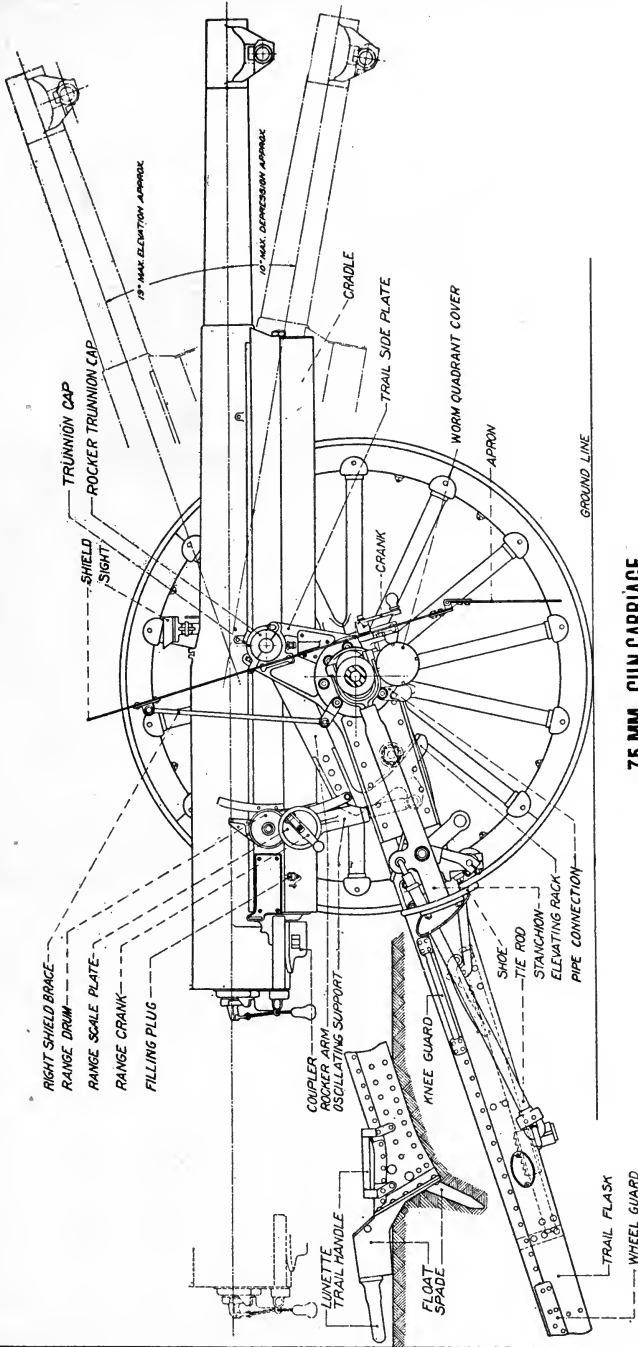

75 MM . GUN CARRIAGE
MODEL OF 1897 M1 (FRENCH)
RIGHT SIDE



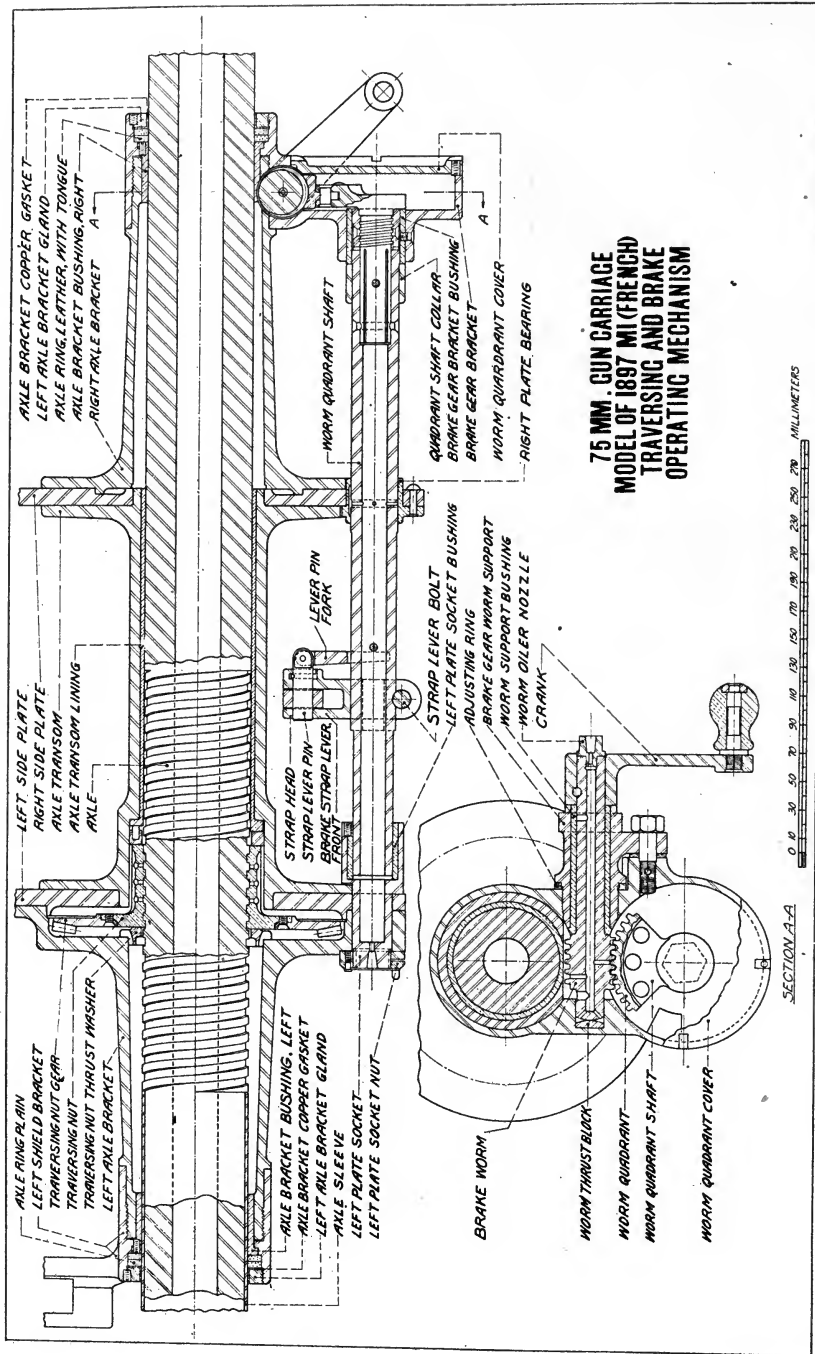

plug, but the forward end of the lower cylinder is closed and contains compressed air at approximately 150 kilograms per square centimeter (1,833.5 pounds per square inch).

In the upper cylinder a piston is permitted to move, the piston rod, however, being secured to the gun. The lower cylinder is fitted with a pipe, at the end of which is a circular ring, this pipe being screwed in the rear part of the cylinder where the valves are housed. A diaphragm equipped with a hollow rod, also a floating piston fitted with a small rod, are incorporated in the lower cylinder.

During recoil the piston of the upper cylinder compresses the liquid, forcing it to pass through various valves, also openings formed between the pipe and the hollow rod of the diaphragm. The passing of the liquid through these different openings constitutes the

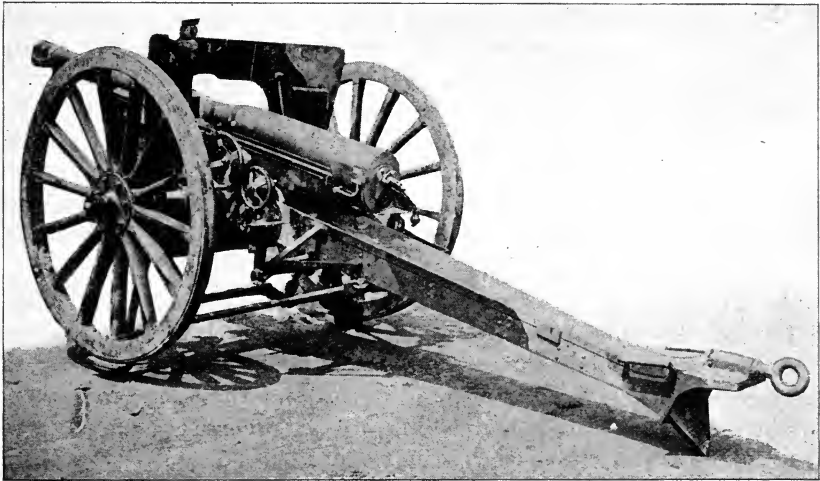

LEFT SIDE VIEW OF CARRIAGE.

braking, in so moving, the liquid opens the valves (which are widely opened at the beginning of the recoil and gradually close in proportion to the decrease of the speed of the recoil). At the same time, the air in the lower cylinder is compressed by the action of the liquid on the diaphragm. To return to battery at the end of the recoil, the compressed air forces the diaphragm back. The liquid thus compressed acts directly on the upper cylinder piston, causing it to return to its initial position.

The interior of the recoil mechanism was maintained confidential by the French Government before and during the war, and when its manufacture was taken over by the Ordnance Department, agreement was made to continue the secrecy of these parts. Very fine adjustments are made when the parts are assembled, and consequently no repairs or adjustments are permitted to be made in the field. The complete recoil mechanism must be sent to special

repair depots. The recoil mechanism will function properly without the operating personnel understanding the interior mechanism.

The *angle of site mechanism* consists of a handwheel and gears, and provides for elevating or depressing a rocker 13 degrees with reference to the trail. The rocker fits around the trunnions and has a segment of a gear which meshes with the elevating pinion. To the rocker is secured an elevating screw and nut which connects with the cradle. In setting the angle of site, the rocker is set in motion, thereby moving the cradle and gun.

The *range scale mechanism* which operates the elevating screw provides an elevation of 12 degrees to give the correct range and is obtained by movement of the cradle in reference to the rocker.

The circular scale graduated in meters indicating the range, is mounted on the side of the cradle and through gearing is connected to the elevating screw. A range rack is connected to the rocker arm which is also graduated in meters. On carriages made in America an extra strip is placed alongside the range rack and is graduated in mils. The range scales are graduated up to 5,500 meters, but greater ranges can be obtained by burying the trail, and thus giving higher angles of elevation. Interference of the breech against the trail, however, limits the total possible elevation obtainable by combination of the elevation due to the angle of site and due to range to 19 degrees.

On this carriage *axle traverse* is used. A geared nut, held inside of the axle housing, rotates around the axle which is threaded with a coarse rectangular thread. Movement of this nut forces the carriage to the right or left, pivoting around the spade, one wheel advancing and the other backing up. Traverse is about three degrees right and three degrees left.

A combination *road brake* and firing support is hung around the axle, permitting the application of brake shoes against the tires of the wheels when traveling, and the lowering of the framework to the ground and mounting the wheels thereon, for firing. This last operation is called *abatage*, the three steps being indicated in the following figures:

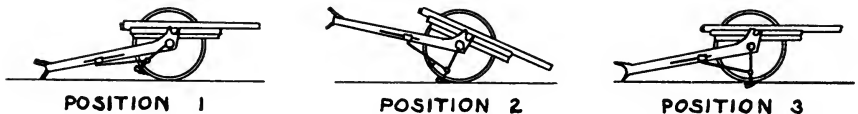

ABATAGE POSITION

Wooden wheels, 1,334 millimeters (52.5 inches) diameter, are used, and have steel tires 3.5 inches wide. These wheels are interchangeable with the French limber wheels, but not with the American limber or caissons for the 75-millimeter gun carriages.

**75 MM. GUN CARRIAGE
MODEL OF 1897 MI (FRENCH)
PLAN VIEW**

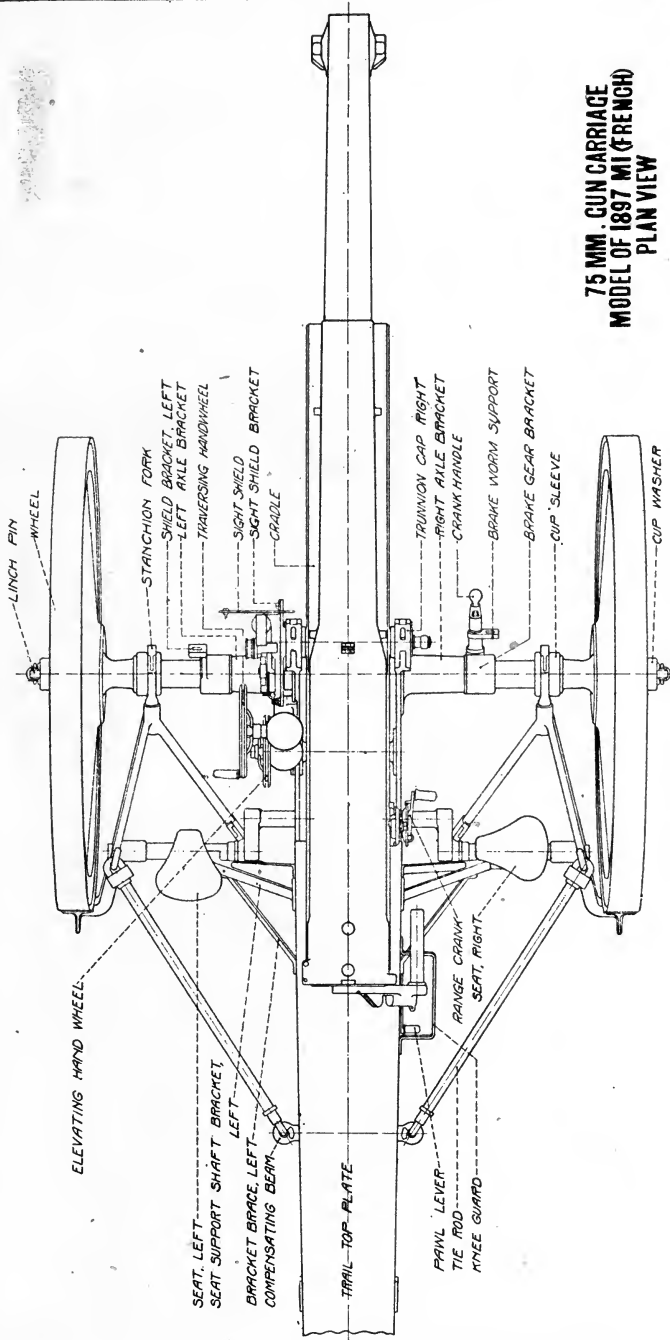

0 40 80 120 160 200 240 280 320 360 400 440 480 520 560 600 640 680 720 760 800 840 880 920 MILLIMETERS

CL 33-36-27130V2-DRAWING USE

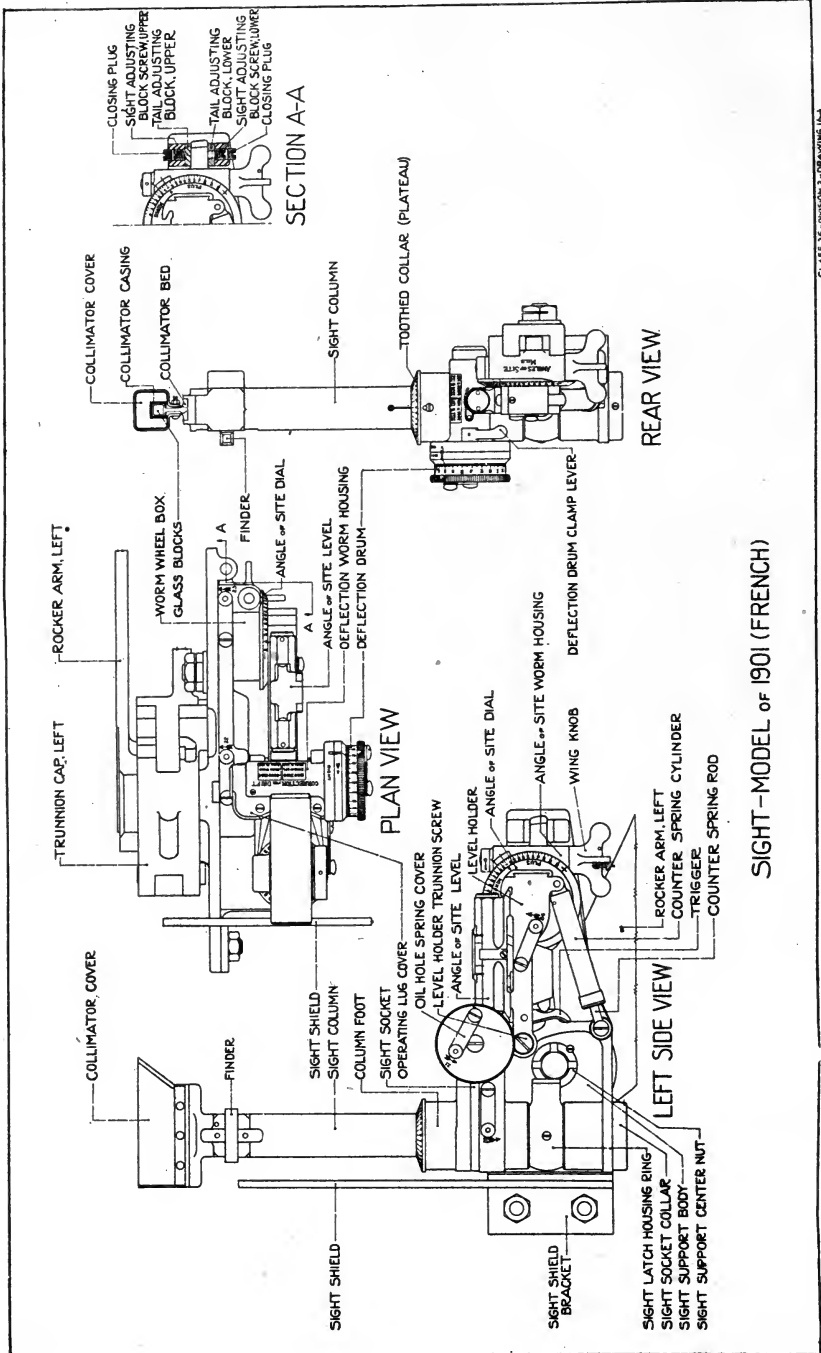

SIGHT-MODEL OF 1901 (FRENCH)

The customary shield and apron protects the gunners when under fire.

The angle of site mechanism is also called the *independent line of sight*, because the range setting is independent of the setting of the angle of sight, which is done by the angle of sight handwheel.

The *sight*, model of 1901 (French), includes the collimating sight, angle of site level, and angle of site scale. It is mounted on the left side of the rocker, at the trunnions. It has no telescopic features and, therefore, its range is limited. An auxiliary angle of site level is furnished to replace the regular level and gives an additional 200 mils for use in the hilly or mountainous country.

Fixed ammunition is used in this 75-millimeter field gun and is made up with either common shrapnel or common steel shell. Shrapnel rounds are issued with the projectiles filled and fuzed; the shell rounds are issued filled but not fuzed, and contain an adapter with booster charge.

The projectiles average in weight: Shrapnel, 16 pounds, fuzed; shell, 12.3 pounds, fuzed. The components of one round are the cartridge case, with primer; the powder charge; projectile; and fuze, in shrapnel; and adapter and booster in the shell.

75-MILLIMETER GUN MATÉRIEL, MODEL OF 1897M1 (FRENCH)

A battery of 75-millimeter gun carriages, model of 1897M1 (French) is accompanied by the following vehicles:

75-millimeter gun and carriage, model of 1897M1.

75-millimeter gun carriage limber, model of 1918.

75-millimeter gun caisson, model of 1918.

75-millimeter gun caisson limber, model of 1918.

Battery and store wagon, model of 1917.

Forge limber, model of 1902M1.

Store limber, model of 1902M1.

Battery reel, model of 1917.¹

Reel, model of 1909M1.¹

Cart, model of 1918.¹

The gun and carriage are of the French design, and of both French and American manufacture. The accompanying vehicles are all of American design and manufacture.

¹ For horse batteries the battery reel, model of 1917, is issued. For motorized batteries, the reel, model of 1909 M1, with the cart, model of 1918, is issued in lieu of the battery reel, model of 1917.

75-MILLIMETER GUN MATÉRIEL, MODEL OF 1917 (BRITISH).

The 75-millimeter gun, model of 1917 (British), was originally known as the 18-pounder, but was modified by adapting it to the 75-millimeter caliber matériel. This weapon is equipped with customary unit trail; the interference of the trail with the breech limits the gun elevation. With the split trail, the breech can pass down into the V formed by separating the two sections of the trail. The theoretical elevation for obtaining maximum range under ideal ballistic conditions is 45° from the horizontal, and is actually some few

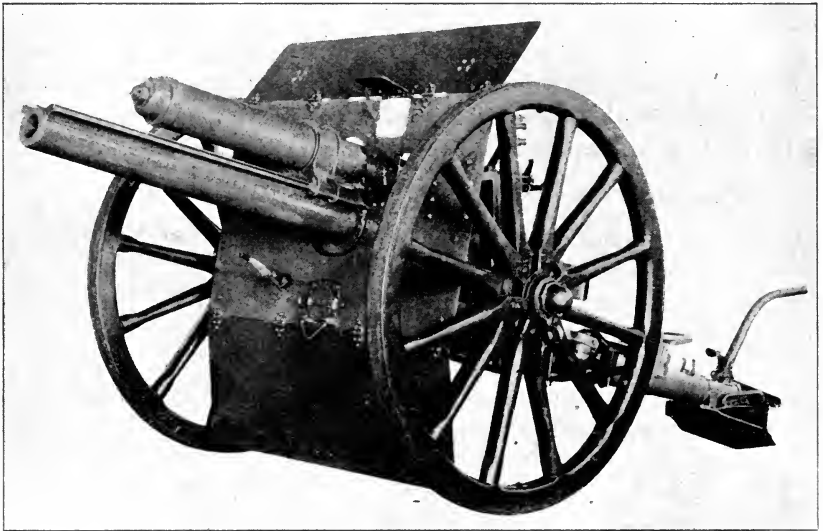

FRONT VIEW OF CARRIAGE.

degrees less than this. Increased range is sometimes obtained with field guns whose normal elevation is limited by setting the axles or wheels on raised surfaces, or by sinking the trail below the level of the wheels, for the purpose of pointing the gun at an elevation higher than the mechanical arrangement of the carriage permits. This is, however, a subterfuge, limited in its practical application.

The American model 1916 split-trail carriage permits great elevation within the mechanism of the carriage and likewise a wide traverse without changing the position of the trail. The recoil mechanism on the 1916 model was adapted to the higher permissible elevation of the gun, and was supplied with a variable recoil, automatically adjusted to different elevations. The ability to outrange

75mm. Gun Carriage, Model of 1917. (British)

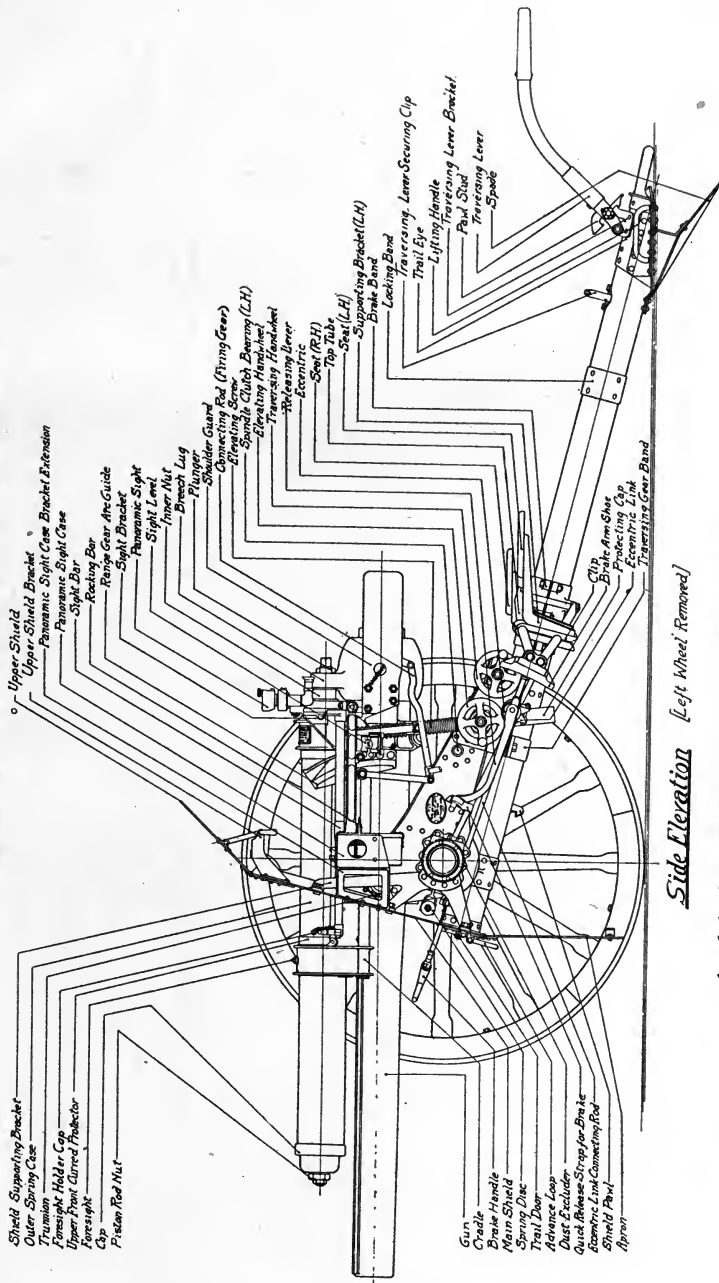

Side Elevation [Left Wheel Removed]

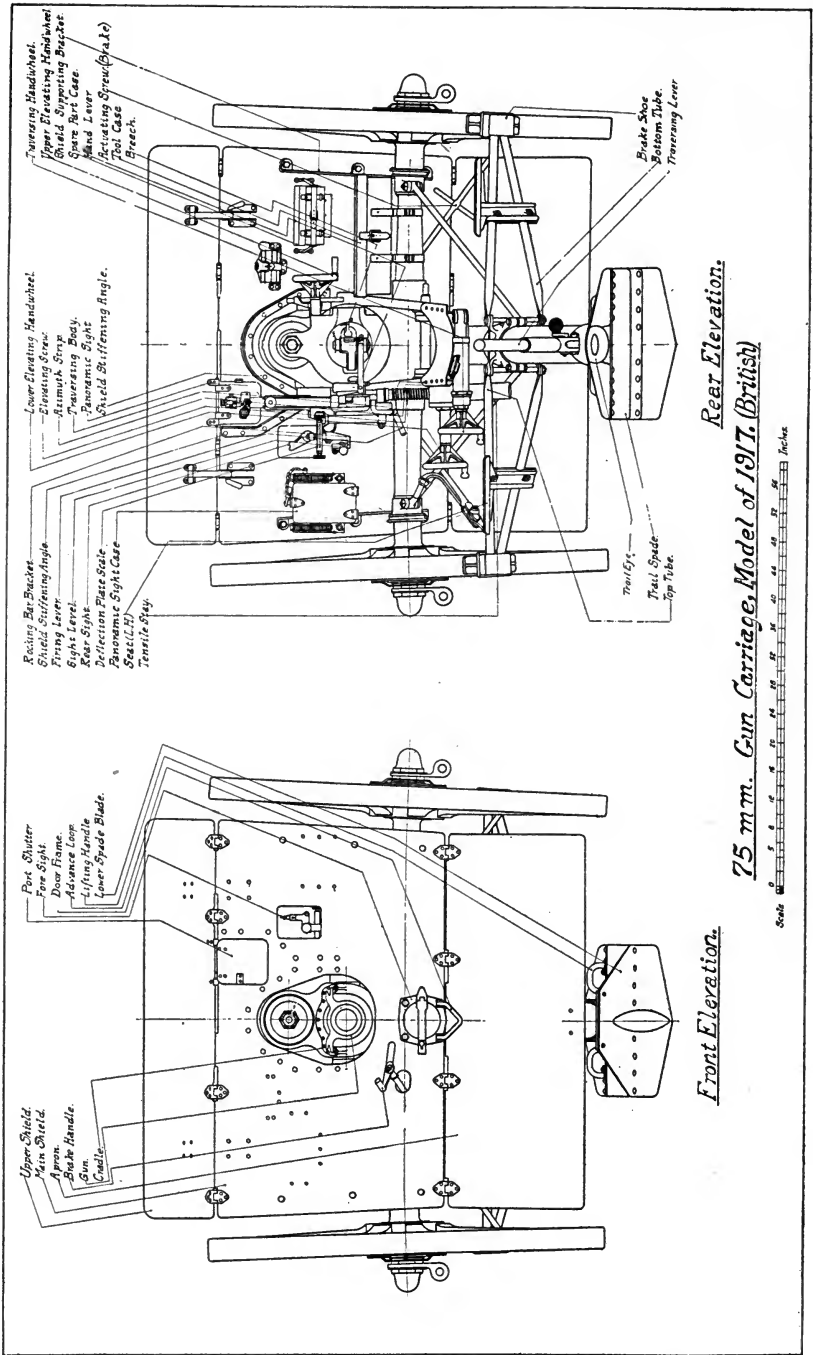

Rear Elevation.

75 mm. Gun Carriage, Model of 1917. (British)

Front Elevation.

the enemy is an attainment constantly being sought, and therefore high elevation and reduction of resistance of the projectile passing through air are the means through which it was hoped to obtain the increased range desired. Likewise, a wide horizontal arc of fire, without resetting of the trail and consequent resetting of the sighting devices, is a great convenience and saver of time.

As compared with the British model 1917, the American 3-inch model of 1902 carriage permits of a maximum angle of elevation of 15° , depression of 5° , and traverse of 142 mils, while the British model permits 16° elevation, 5° depression, and 142 mils traverse. The French model 1897 carriage permits a maximum angle of eleva-

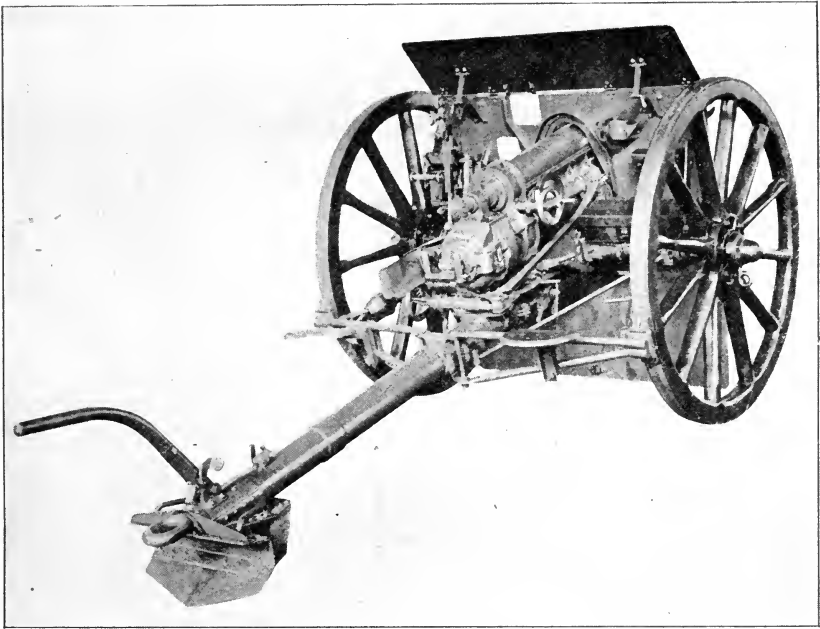

REAR VIEW OF CARRIAGE.

tion of 19° , depression 10° , and traverse 106 mils. The American model 1916 carriage allows a total vertical movement of from 53° elevation to 7° depression, and a traverse of 800 mils (an artillery mil equals the angle of $\frac{1}{6400}$ of a circumference). The American model 1902 carriages are arranged with an hydro-spring recoil mechanism, and so is the British model 1917 and the American model 1916. The French model 1897 carriage is equipped with an hydro-pneumatic recoil mechanism.

The basic difference of the recuperator or recoil mechanism of the French model 1897 gun, as compared with the British model and the American model, lies in the fact that the French model involved the principle of oil and compressed air for absorbing the recoil of the gun

and returning it to battery or firing position, and is practically self-contained in one large heat-treated steel forging, with a system of finely fitted surfaces and adjustment valves. In the British and American model recoil mechanism, oil and steel springs, instead of compressed air, are employed, with a combination of pistons and steel tubing.

A reference may also be made relative to the desirability of single or unit trails as compared with the split trail. The latter allows of greater traverse, but as a new objective makes necessary a resetting of the trail, the change in setting requires much more time than with the unit trail. The split trail is heavier and the equalizing mechanism, necessary to the proper distribution of recoil shock to both trail sections, establishes a relative movement between the two trail sections, with the result that the split trail can be set up less quickly than the unit trail on uneven ground.

Weights, dimensions, and ballistics.

Caliber.....	millimeters..	75
Weight of gun and breech mechanism.....	pounds..	995
Total length of gun.....	inches..	88. 21
Length of bore.....	do....	83. 915
Rifling, right-hand twist, zero turns at origin to 1 turn in 75 inches at 9.72 inches from muzzle, thence uniform.		
Number of grooves.....		24
Muzzle velocity:		
Shrapnel.....	feet per second..	1, 693
Shell (short fuse).....	do....	1, 900
Shell (long fuse).....	do....	1, 876
Maximum range:		
Shrapnel (Mark IV shell).....	yards..	6, 464
Shell (short fuse).....	do....	8, 100
Shell (long fuse).....	do....	7, 450
Weight of one round of ammunition:		
Shrapnel.....	pounds..	16
Shell.....	do....	12. 3
Weight of carriage, complete (without gun).....	do....	1, 800
Weight of gun and carriage, fully equipped.....	do....	2, 945
Weight of gun and carriage in battery position.....	do....	2, 860
Diameter of wheels.....	inches..	56
Width of track.....	do....	60
Length of recoil of gun on carriage.....	do....	49
Height of axis from ground.....	do....	38. 86
Maximum angle of elevation.....	degrees..	16
Maximum angle of depression.....	do....	5
Maximum traverse, each side of center.....	mils..	72
Weight of gun, carriage, and limber (British) fully equipped, also loaded with shrapnel and fuze boxes.....	pounds..	4, 591
Weight of gun, carriage and limber (American) fully equipped, also loaded with shrapnel and fuze boxes.....	pounds..	4, 458

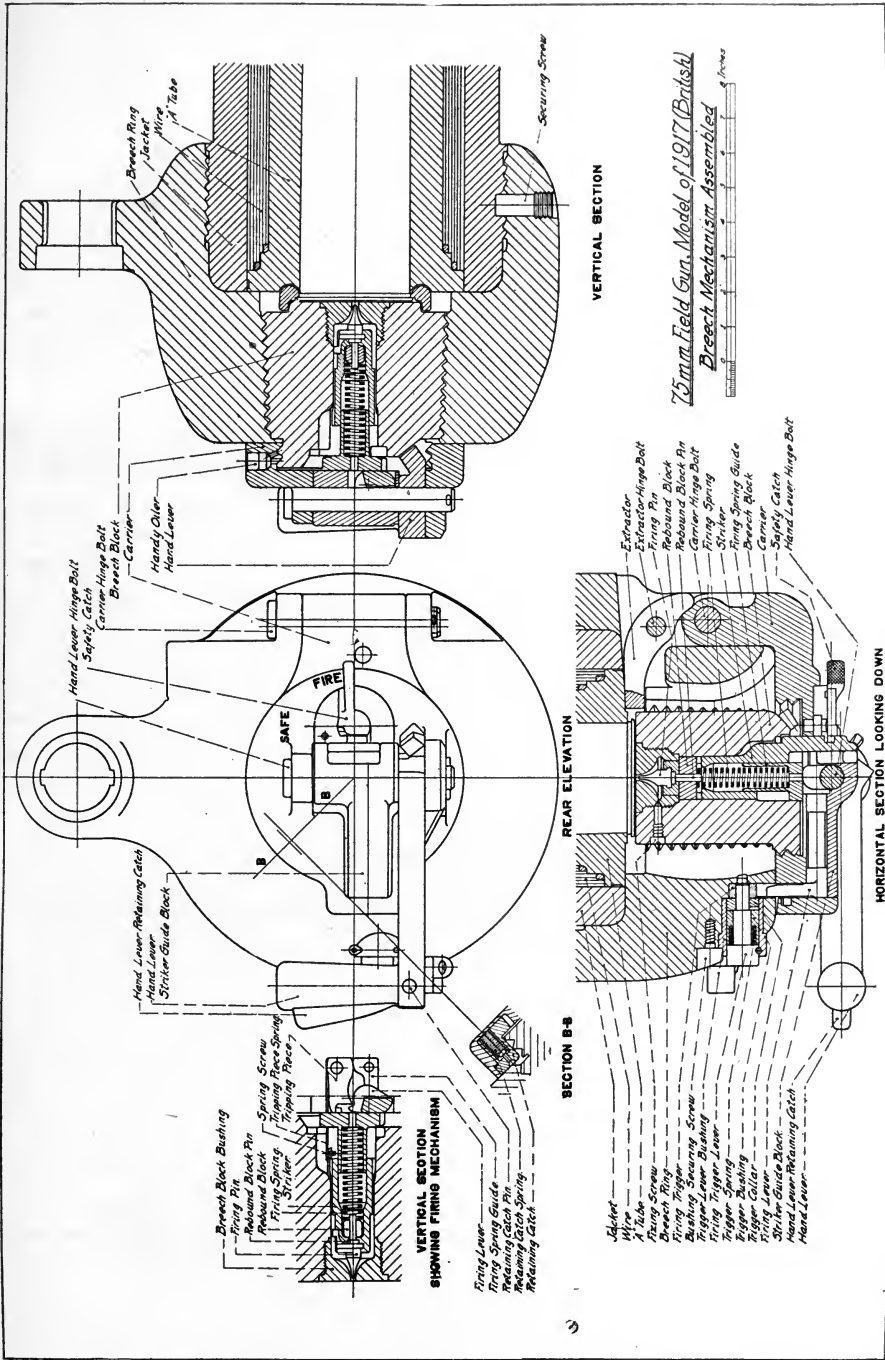

75-MILLIMETER GUN AND CARRIAGE, MODEL OF 1917 (BRITISH.)

The gun is built up of alloy steel, consisting of a tube, a series of layers of steel wire, jacket, and breech ring. The tube extends from the rear end of the chamber to the muzzle. Over the rear portion of the tube are wound 15 layers of steel wire. The jacket is fitted over the exterior of the tube and wire, and is secured longitudinally by corresponding shoulders and the breech ring, which is screwed over the jacket at the rear and secured by a set screw. The breech ring is prepared for the reception of the breech mechanism, and is provided on the upper side with a lug for the attachment of the hydraulic buffer. Longitudinal projections on each side of the jacket form guides for the gun when in the cradle of the carriage. A plane for a clinometer is prepared on the upper surface of the breech ring. Vertical and horizontal axis lines are cut on the face of the muzzle for use in verifying the adjustments of the sight.

The breech block is of the interrupted screw type having two threaded and two slotted sectors. The breech recess of the gun is slotted and threaded to correspond with the threads on the block and the latter is screwed to a cylindrical section, or carrier, which is hinged to the right side of the breech. Hinged to the rear face of the carrier is a hand lever, provided with bevel teeth which engage with corresponding teeth on the rear face of the breech block, so arranged that when the lever is pulled to the right, the first movement of the lever unlocks the breech block, and on continuing the motion the block and carrier are swung into the loading position. The breech is opened by the cannoneer on the right seat pulling the hand lever toward him. The extractor, hinged to the right side of the breech, is automatically actuated in opening the breech, thus ejecting the empty cartridge case.

The firing mechanism is so arranged that the gun can not be fired before the breechblock is home and the hand lever locked and is known as a continuous-pull mechanism. By means of the firing lever on the left side of the gun, operated by the gunner, the firing pin which seats in an axially bored hole in the breechblock, is cocked and fired by one continuous backward motion of the lever.

The carriage has a tubular steel trail and axle, the rear end of the trail being fitted with a spade, lifting handles, trail eye, and traversing lever. The top carriage is provided with bearings, by means of which it is pivoted on the axle for traversing. Bearings are provided at the top to receive the cradle trunnions on which the cradle pivots. Longitudinal recesses are cut in the inner surface of the lower portion of the cradle for the reception of the guides on the jacket of the gun.

A seat is provided on the left side of the trail for the gunner who sets the sights and fires the gun, and one on the right for a cannoneer who sets the range and operates the breech.

75mm. Gun Carriage, Model of 1917. (British)

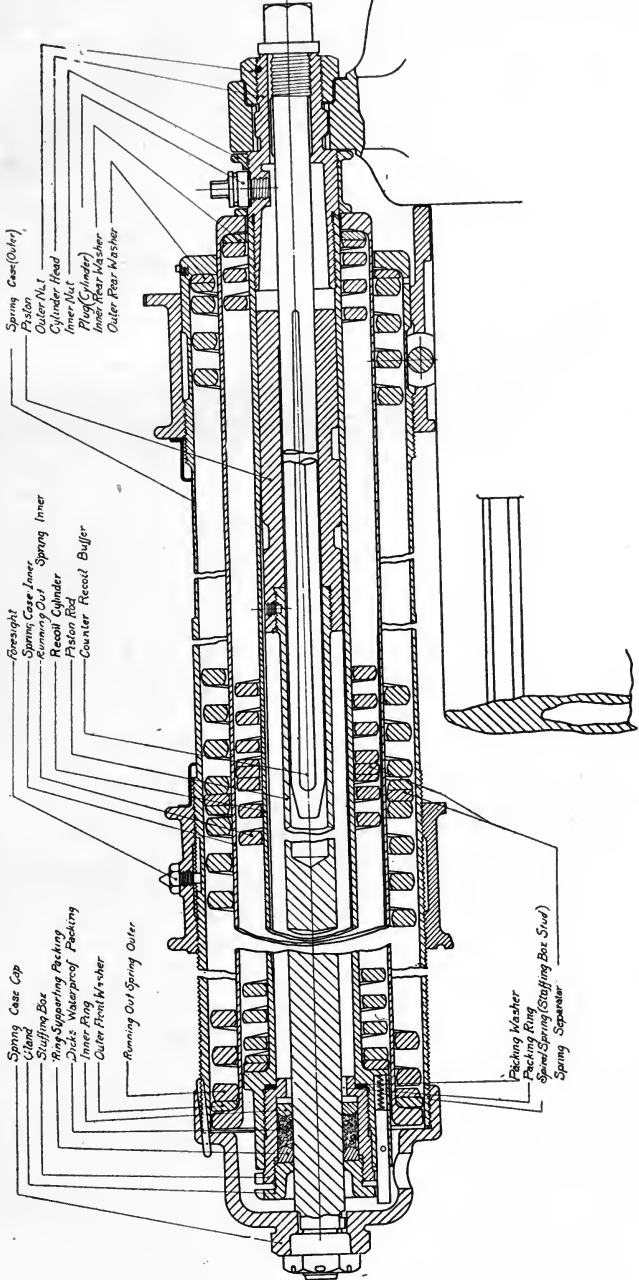

Recoil Controlling System

SCALE IN INCHES 0 1 2 3 4 5 6 7 8 9 10

The customary top and main shields and the apron are provided for the protection of the personnel against gun fire.

The recoil cylinder is contained in the spring case in the upper portion of the cradle and is surrounded by two sets, inner and outer, of four sections each, of counterrecoil (running-out) springs, these being held under initial compression between an external flange on the front end of the recoil cylinder and an internal flange at the rear end of the outer spring case. The cylinder is attached and secured to the rear end of the gun by two nuts, while the piston rod with piston, which fits inside of the cylinder, is secured to the forward end of the spring case. The piston rod is bored out for the reception of the counter recoil buffer which is secured in the rear end of the cylinder.

Upon being fired the gun recoils, carrying with it the recoil cylinder. The oil is forced to pass from in front of the stationary piston to the rear through grooves of graduated depth which set up an hydraulic resistance, thus checking the energy and bringing the gun to rest. In recoiling, the gun further compresses the two sets of springs which, after the gun has reached its maximum recoil, cause it to return to battery. The counter recoil buffer displaces the liquid in the rear end of the piston rod, the liquid being forced to escape over the tapered flats, thus resulting in the gun returning to battery without shock.

A gravity tank is bolted to the front end of the recoil mechanism, which insures the cylinder being constantly filled, and is protected from gun fire by a shield.

The angle of sight level is carried on a bracket riveted to the underside of the rocking bar at the rear end and is adjusted by a leveling screw to which is attached a micrometer disc for setting off the angle of sight.

The range indicator is fitted to the right side close to the handwheel and consists of a meter scale ring graduated on its face in hundreds of meters, the periphery of the ring being graduated in mils. The mechanism allows an elevation of 16° and depression of 5° .

The elevating gear is divided into two portions, upper and lower, and so arranged that the gun may be elevated or depressed without altering the line of sight.

The traversing gear is pivoted to a bracket fastened to the trail at the rear end of the top carriage, and is operated by a handwheel extending out to the left side by means of which the gun may be traversed 72 mils right or left from center. A scale strip and pointer indicate the angle of traverse.

Wooden wheels, 56 inches in diameter, are used, having steel tires 3 inches in width. Drag washers free to rotate about the hubs are secured by the dust caps.

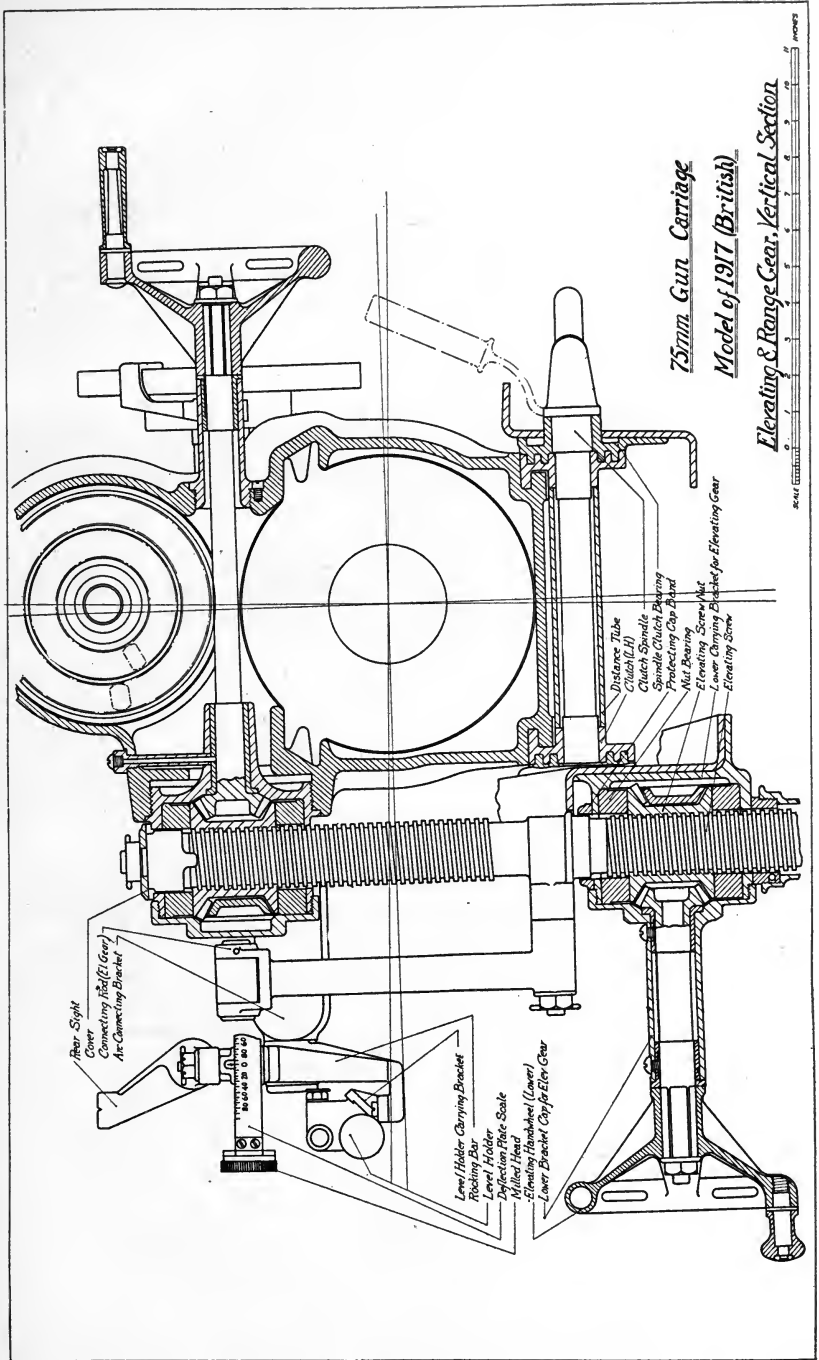

75 mm. Gun Carriage, Model of 1917. (British)

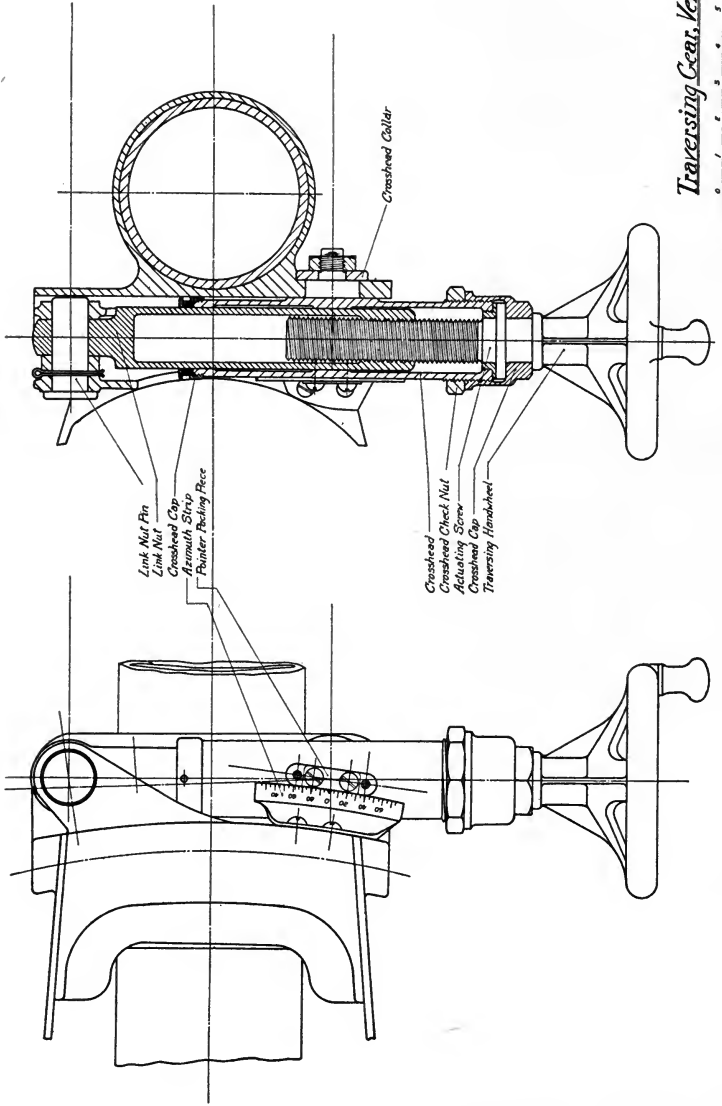

Traversing Gear, Vertical Section & Plan

Scale in inches 0 1 2 3 4 5 6 7 8 9 10 11 12

The *tire brake* is for use in traveling, and is always used when firing. Brake arms are pivoted at one end to a bracket on the trail and have at their other end a cast-iron brake shoe which acts upon the tire of the wheel. The braking action is adjustable and brakes are operated by a lever having an eccentric link at its end.

The *sights* used are the rocking-bar sight and panoramic sight, model of 1917, which are located on the left side of the carriage.

Fixed ammunition is used in this 75-millimeter field gun and is made up of either common shrapnel or common steel shell. Shrapnel rounds are issued with the projectiles filled and fuzed; the shells rounds are issued filled but not fuzed, and contain an adapter with booster charge.

The projectiles average in weight; shrapnel, 16 pounds fuzed; shell 12.3 pounds fuzed. The components of one round are the cartridge case with primer, powder charge, projectile, and fuze in shrapnel, and adapter and booster in shell.

75-MILLIMETER GUN MATÉRIEL, MODEL OF 1917 (BRITISH).

A battery of British 75-millimeter gun carriages is accompanied by the following vehicles:

75-millimeter gun carriage limber, model of 1917, (British).¹

75-millimeter gun carriage limber, model of 1918.¹

75-millimeter gun caisson, model of 1918.

75-millimeter gun caisson limber, model of 1918.

Forge limber, model of 1902 MI.

Store limber, model of 1902 MI.

Battery and store wagon, model of 1917.

Battery reel, model of 1917.

This gun was formerly 3.3 inches in caliber but was modified to 75 millimeter giving interchangeability with French ammunition. All of this matériel used by the American Army was manufactured in the United States. The gun carriage limber, model of 1917, is of British design.

¹ Either one of the above limbers may be issued.

75-MILLIMETER GUN CARRIAGE LIMBER, MODEL OF 1917 (BRITISH).

The standard British limber carries cartridges horizontally, but is not arranged with compartments or diaphragms. The American product of the British limber is superior to the standard British vehicle in that diaphragms are included in the ammunition chests. The limbers are, however, fitted with wooden poles, which are more liable to breakage than steel poles; they have single draft hooks, instead of double trees for equalizing the pull on the braces; the pintle latch is not so effective as the American, nor the ammunition chest doors so well suited to their purpose; and they are not adapted to the American harness, as the distance from the neck yoke to the draft hook is 6-inches shorter than in the American design and our harness can not be so readily connected to the neck yoke.



FRONT VIEW OF LIMBER.

Weights, dimensions, etc.

Weight, complete, empty.....	pounds..	1, 016
Weight of tools and equipment carried.....	do....	114
Weight of ammunition carried.....	do....	516
Weight, completely equipped and loaded.....	do....	1, 646
Weight of gun, carriage and limber, completely equipped with 21 rounds of ammunition.....	pounds..	4, 591
Diameter of wheels.....	inches..	56
Width of track.....	do....	60
Turning angle with carriage.....	degrees ..	70

The British design of gun carriage limber is constructed of a frame consisting of two middle and two outer rails connected at the front and center by a bar and braces and surmounted by an ammunition chest of steel.

75mm. Gun Carriage Limber, Model of 1917. (British)

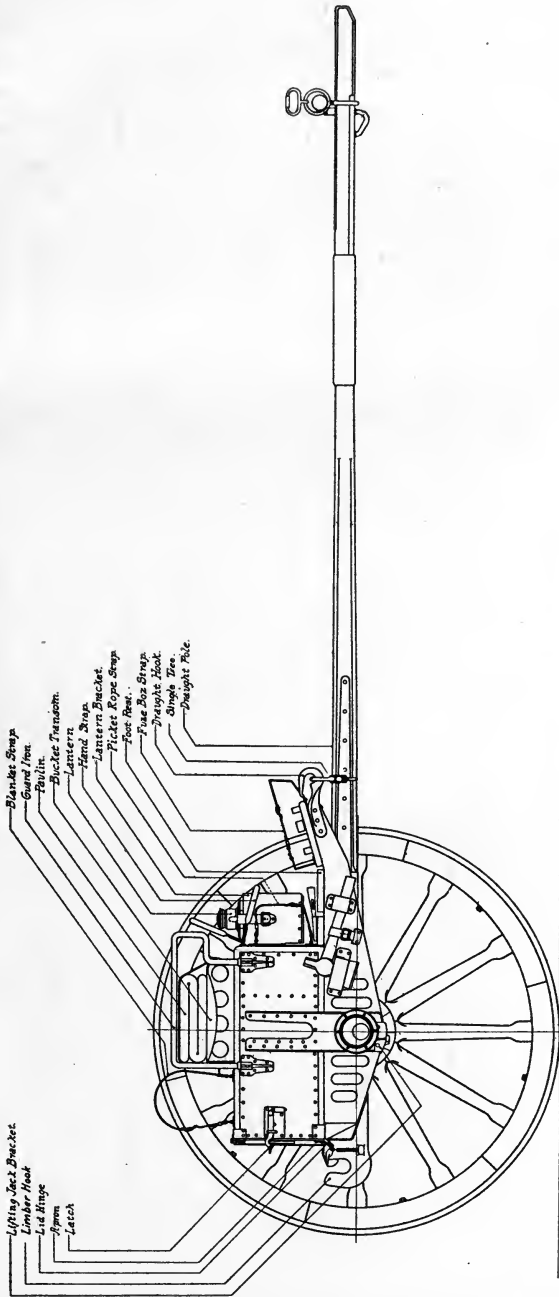

Side Elevation. [Right Wheel Removed.]

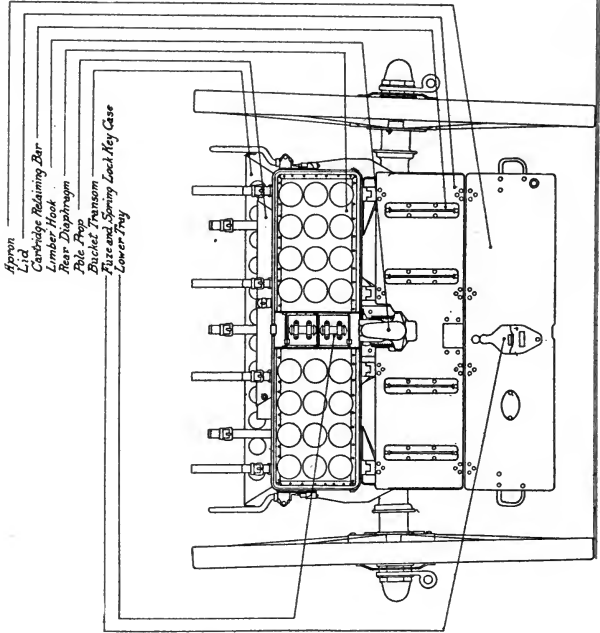
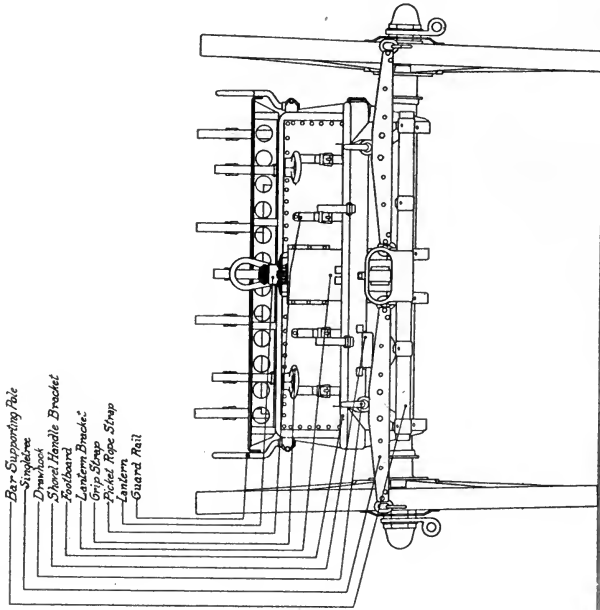

Rear Elevation *Front Elevation*

75mm. Gun Carriage Limber, Model of 1917 (British)



The chest opens at the rear and is fitted with perforated diaphragms for carrying 24 rounds of fixed ammunition and a compartment in the center holding two wooden trays for small stores.

The pole is of wood, protected at the front end by steel wrapping plates and fitted with a neck yoke for use with breast collar harness.

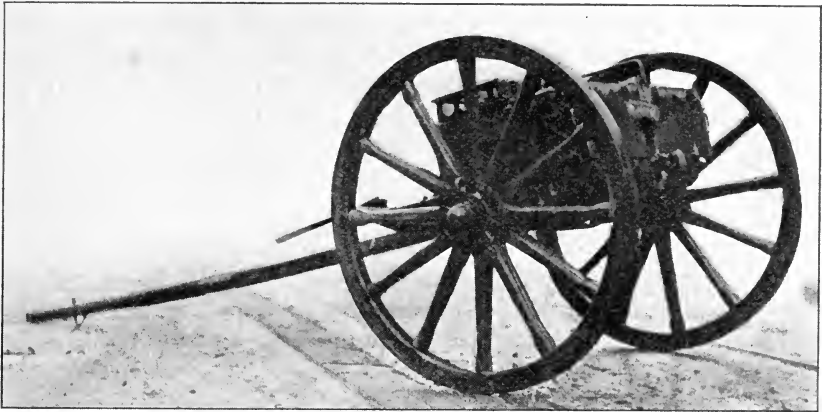

REAR VIEW OF LIMBER.

The axle is a seamless steel tube fixed to the rails by flanges, and the wheels are the same as those used on the gun carriage.

This limber is used only in connection with the 75-millimeter gun carriage, model of 1917 (British).

The 75-millimeter gun carriage limber, model of 1918 (American) a description of which may be found on page 110, can be used as an alternate for this vehicle.

75-MILLIMETER GUN CARRIAGE LIMBER, MODEL CF 1918.

The limber is of American design, and is of metal throughout, excepting the spokes and felloes of the wheels. The frame consists of a middle rail and two side rails. The middle rail is in the form of a split cylinder, one-half passing below and the other half above the axle, uniting in front to form a seat for the pole and in the rear to form a seat for the pintle-bearing guide. An automatic pole support, described on page 160, is provided.

The ammunition chest is a rectangular steel box, having a door at the rear hinged at the bottom, and swinging downward to an approximately horizontal position. Three perforated diaphragms within the chest support 18 rounds of fixed ammunition and 3 tubular oil cans.

The axle is of forged steel, made in one piece. The standard 56-inch wheels are used. See page 158.

This limber is used in connection with American, British, and French 75-millimeter matériel.

Weights, dimensions, etc.

Weight complete, empty.....	pounds..	963
Weight of tools and equipment carried, oil cans filled.....	do....	134
Weight of ammunition carried (shrapnel).....	do....	365
Weight of fuze boxes, loaded.....	do....	62
Weight, completely equipped and loaded.....	do....	1,524
Rounds of ammunition carried in limber chest.....		18
Diameter of wheels.....	inches..	56
Width of track.....	do....	60
Free height under limber.....	do....	24
Turning angle with carriage.....	degrees..	78

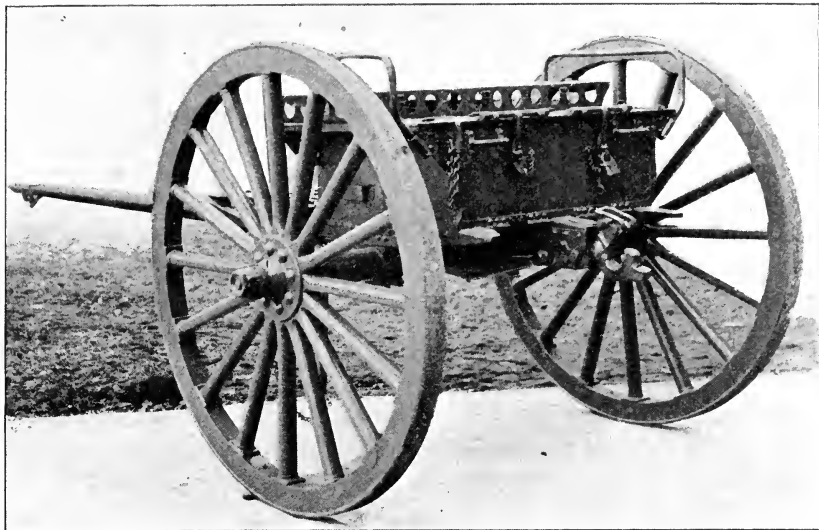

REAR VIEW OF LIMBER.

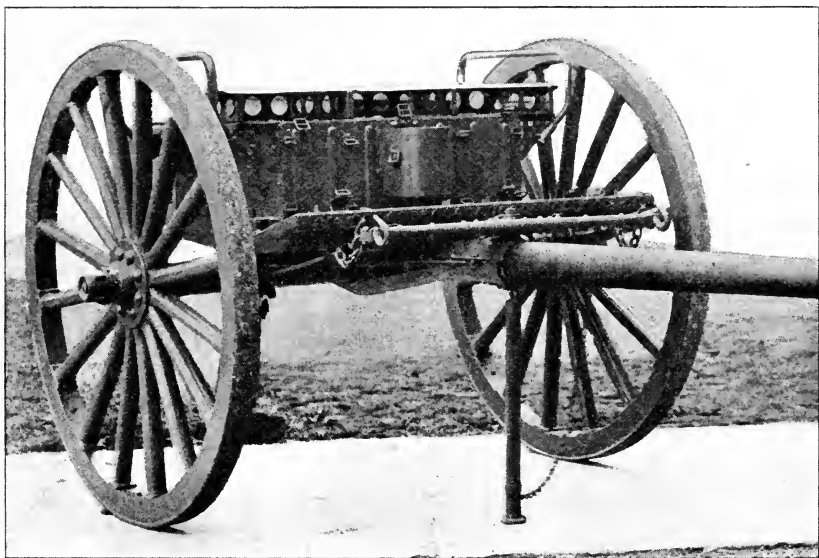

FRONT VIEW OF LIMBER.

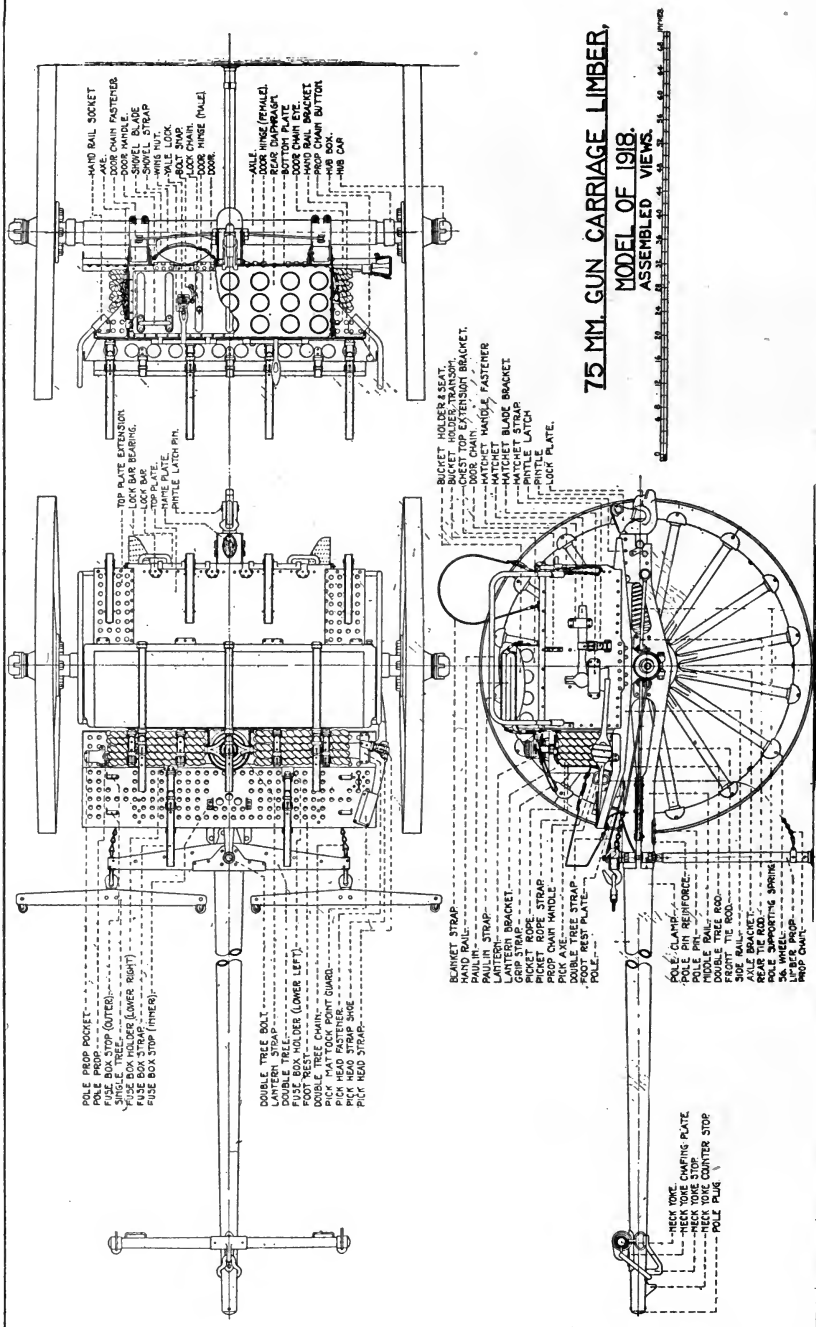

**75 MM. GUN CARRIAGE LIMBER,
MODEL OF 1918.
ASSEMBLED VIEWS.**

HAND RAIL SOCKET
—DOOR CHAIN FASTENER
—DOOR HANDLE
—SPOOL STRAP
—WIRE NUT
—MULE LOCK
—MULE LOCK CHAIN
—DOOR HANDLE (MULE)

MULE
—DOOR HANDLE (MULE)
—MULE LOCK
—MULE LOCK CHAIN
—DOOR HANDLE (MULE)
—MULE LOCK
—MULE LOCK CHAIN
—DOOR HANDLE (MULE)

TOP PAINT EXTENSION
—TOP BAR BUSHING
—LOCK PLATE
—PRITTLE LATCH PIN

BUCKET HOLDER ASSEMBLY
—BUCKET HOLDER TRANSPORT
—BUCKET HOLDER TRANSPORT
—MATCHET HANDLE FASTENER
—MATCHET BLADE BUCKET
—PRITTLE LATCH
—LOCK PLATE

POLE PROP POCKET
—PALE PROP
—FUZE BOX STOP (OUTER)
—FUZE BOX HOLDER (LOWER RIGHT)
—FUZE BOX STRAP
—FUZE BOX STOP (INNER)

DOUBLE TREE BOLT
—LOWER STRAP
—FUZE BOX HOLDER (LOWER LEFT)
—FOOT REST
—PICK HEAD FASTENER
—PICK HEAD STRAP

BUCKET STRAP
—HAND RAIL
—PAULIN STRAP
—LANTERN STRAP
—LANTERN BRACKET
—PICKET HEAD STRAP
—PICKET ROPE STRAP
—PICKET CHAIN HANDLE
—PROP CHAIN HANDLE
—DOUBLE TREE STRAP
—FOOT REST PLATE
—POLE

HECK YOK
—HECK YOK CHAMFER PLATE
—HECK YOK STOP
—HECK YOK COUNTER STOP
—POLE PAIR

POLE CLAMP FORCE
—POLE PIN
—MIDDLE RAIL
—FRONT TIE ROD
—SIDE RAIL
—FRONT TIE ROD
—POLE SUPPORTING SPRING
—56 WHEEL
—PROP CHAIN

75-MILLIMETER GUN CAISSON, MODEL OF 1918.

The caisson consists of a steel chest carried on wheels and axle by means of a spring support. This support consists of helical springs held by suitable axle and chest brackets at each end of the chest. The Belleville springs absorb the shock of rebound.

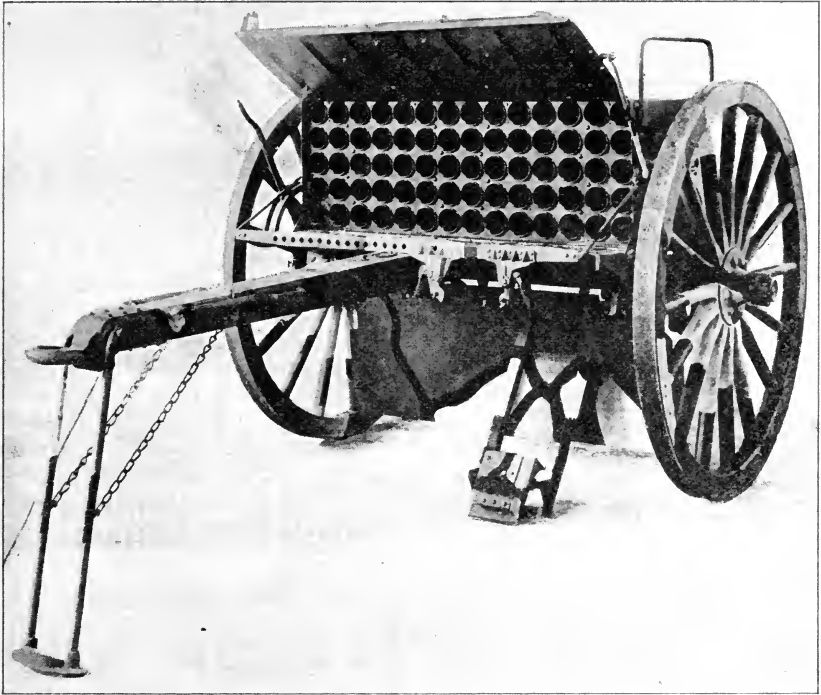

FRONT VIEW OF CAISSON.

The chest carries 70 rounds of ammunition arranged in 5 horizontal rows of 14 each. Protection from small-arms fire is provided by the front door, rear plate, and apron, which are made of armor plate. The chest provides seats for three cannoneers, and is equipped with fastenings for carrying a full complement of tools. A rack is provided at the back of the chest for carrying fuze boxes. On the front left side of the chest is fastened the fuze setter.

The caisson is equipped with a short pole and lunette combined with a pole prop. On the rear the standard pintle is provided.

Standard 56-inch wheels are used and band brakes are provided.
See page 158.

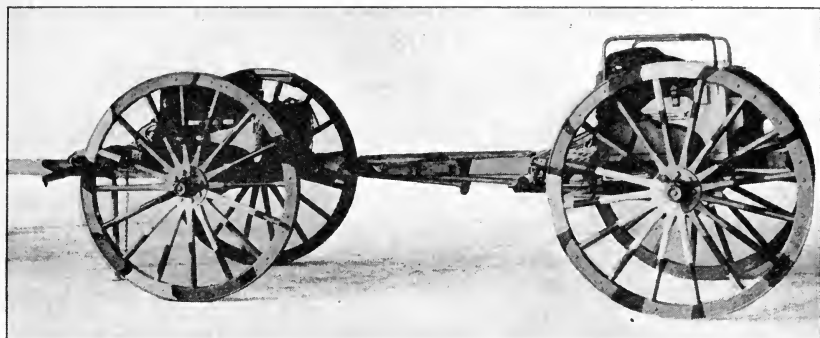

GUN CAISSON AND GUN CAISSON LIMBER, LIMBERED.

Weights, dimensions, etc.

Weight complete, empty.....	pounds..	1,425
Weight of tools and equipment carried.....	do....	62
Weight of ammunition carried (shrapnel).....	do....	1,421
Weight of fuze boxes, loaded.....	do....	124
Weight completely equipped and loaded.....	do....	3,032
Weight with limber completely equipped and with 106 rounds of ammunition.....	pounds..	4,961
Rounds of ammunition carried.....		70
Diameter of wheels.....	inches..	56
Width of track.....	do....	60
Free height under caisson.....	do....	21
Turning angle with limber.....	degrees..	81

75-MILLIMETER GUN CAISSON LIMBER, MODEL OF 1918.

The gun caisson limber is practically the same as the gun carriage limber, model of 1918, except that the chest is larger and carries more ammunition. Each diaphragm is perforated with 39 flanged holes, which accommodate 36 rounds of ammunition, and three tubular oil cans.

This limber is used in connection with the American, British, and French 75-millimeter matériel.

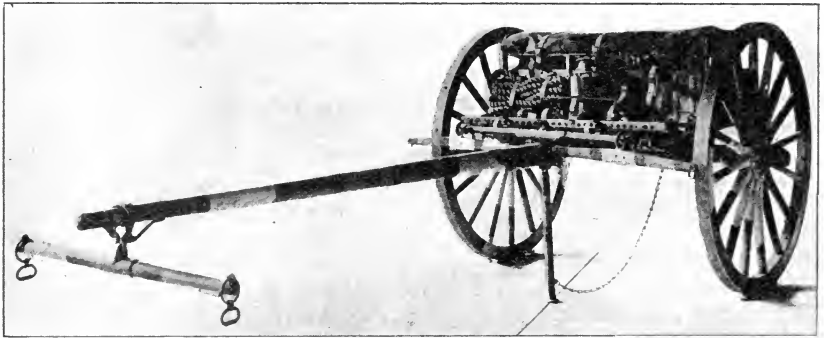

FRONT VIEW OF CAISSON LIMBER.

Weights, dimensions, etc.

Weight, complete, empty.....	pounds..	1,003
Weight of tools and equipment carried (oil cans filled).....	do....	134
Weight of ammunition carried (shrapnel).....	do....	730
Weight of fuze boxes, loaded.....	do....	62
Weight, completely equipped and loaded.....	do....	1,929
Rounds of ammunition carried in limber chest.....		36
Diameter of wheels.....	inches..	56
Width of track.....	do....	60
Free height under limber.....	do....	24
Turning angle with caisson.....	degrees..	81

75MM GUN CAISSON LIMBER.
MODEL OF 1918
ASSEMBLED VIEWS

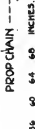
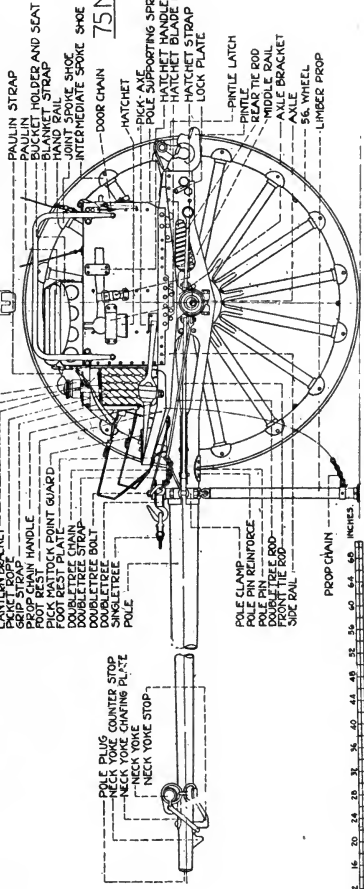
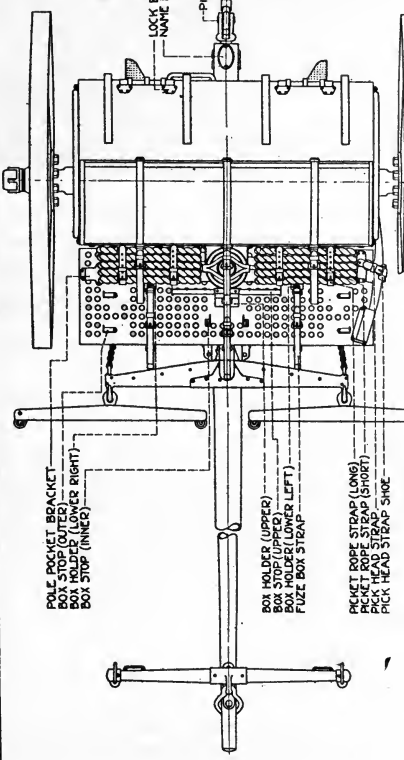
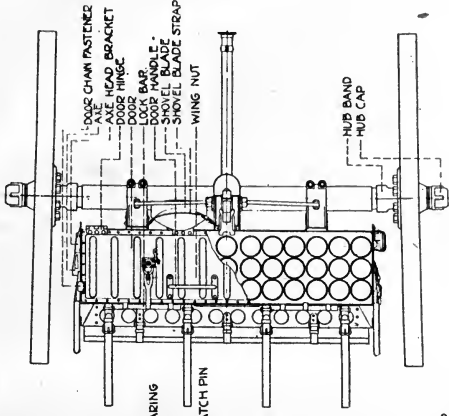

3-INCH GUN MATÉRIEL, MODEL OF 1902.

When the United States entered the World War there were on hand approximately 544 3-inch field guns, model 1902, and the necessary equipment therefor. The 3-inch, model 1902, matériel includes gun, carriage, limber, caissons, caisson limbers, battery wagons, forge limbers, store wagons, store limbers, combination battery, store wagons and limbers, battery reel, also reel and carts, as issued to the 75-millimeter matériel.

The needs of the fighting army received first attention, but a large number of troops in the training areas and camps required matériel for use in their preliminary instructions; thus 154 batteries of 3-inch model 1902, matériel were distributed for training purposes in the United States which were considered substitutes for the 75-millimeter matériel.

The 3-inch field gun, American model 1902-1904-1905, is equipped with a breechblock of the interrupted-screw type. The breech mechanism consists of a handle pivoted vertically to provide horizontal movement of the handle to the right to open the breechblock. In opening, the mechanism performs two functions: Revolves the breechblock, releasing it from the threads, and then swings the block open. At the same time the cartridge case is ejected from the gun. In closing, the threaded movement firmly seats the cartridge in the powder chamber, and the threads withstand the backward thrust of the powder gases.

The recoil mechanism is of the hydro-spring type, with the housing attached to the carriage, and located underneath the cannon. The firing mechanism, in the latest design, is operated either by a lanyard attached to the trigger, or by means of a firing handle on the cradle, and is of the continuous-pull type. When the breechblock is unlocked the gun can not be fired.

Weights, dimensions, and ballistics.

Weight of gun:		
Models of 1902 and 1904.....	pounds..	835
Model of 1905.....	do....	788
Caliber.....	inches..	3
Length of gun.....	do....	87.8
Length of bore.....	do....	84
Length of rifled portion of bore.....	do....	72.72

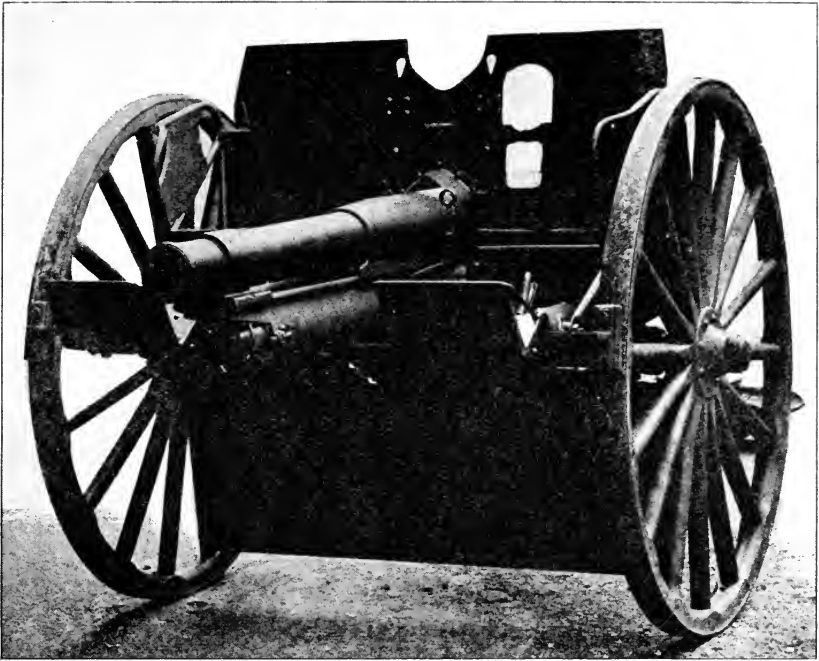

FRONT VIEW OF CARRIAGE.

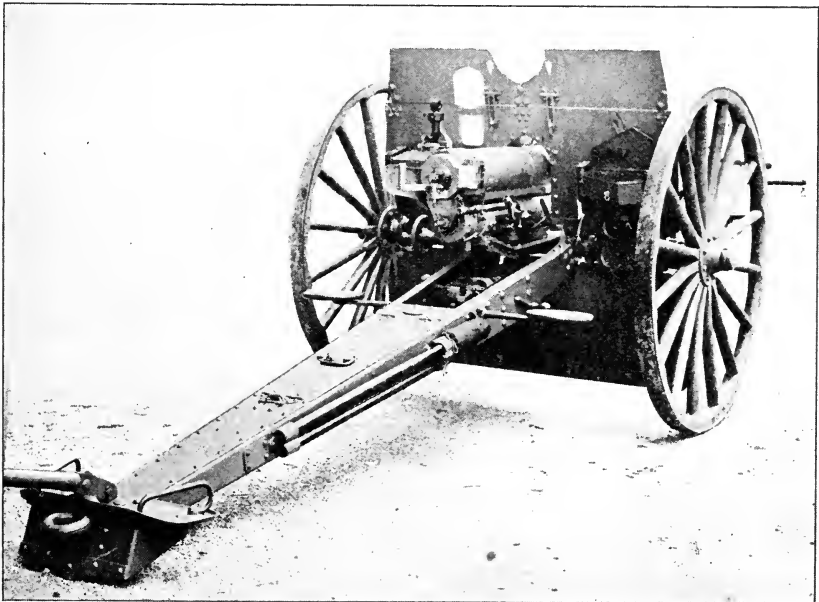

REAR VIEW OF CARRIAGE.

Rifling:

Number of grooves.....	24
Width of grooves.....	inch 0.2927
Depth of grooves.....	do 0.03
Width of lands.....	do 0.01

Twist, right-hand:

Models of 1902 and 1904; 1 turn in 50 calibers at origin to 1 turn in 25 calibers at 12.52 inches from muzzle, thence uniform.

Model of 1902: 0 turn at origin to 1 turn in 25 calibers at 9.72 inches from muzzle, thence uniform.

Weight of projectile (filled and fuzed).....	pounds 15
Weight of cartridge case.....	do 2.25
Weight of fixed ammunition (1 round).....	do 18.75
Capacity of cartridge case.....	cubic inches 66.5
Muzzle velocity.....	feet per sec 1,700
Maximum pressure per square inch.....	pounds 33,000
Range at 15° elevation.....	yards 6,000
Maximum range (approximately).....	do 8,500
Weight of carriage with 4 rounds of ammunition, weighing 75 pounds.....	pounds 1,685
Weight of gun and carriage, fully equipped.....	do 2,520
Weight at end of trail, carriage limbered.....	do 115
Diameter of wheels.....	inches 56
Width of track.....	do 60
Length of recoil of gun on carriage.....	do 45
Height of axis of gun.....	do 40.875
Height of line of peep sight.....	do 44.9
Length of peep-sight radius.....	do 36.75
Maximum angle of elevation.....	degrees 15
Maximum angle of depression.....	do 5
Amount of traverse of gun and carriage.....	mils 140
Rounds of ammunition carried on carriage.....	4

3-INCH GUNS, MODELS OF 1902, 1904, AND 1905, AND CARRIAGE MODEL OF 1902.

The guns are of three models, 1902, 1904, and 1905, and are practically the same except that the latter two models differ from the 1902 model in breech mechanism and the 1905 model is 50 pounds lighter in weight.

The gun is built up of nickel steel and consists of a tube, the rear portion of which is enveloped by a jacket which also projects beyond the rear end forming a recess for the breech block. A locking hoop is shrunk on the tube and the forward end of the jacket to secure the latter to the tube. The front clip is a short hoop shrunk on the tube near the forward end which guides the gun in recoil.

The breechblock on all three models is of the interrupted-screw type, and rotates in the block carrier which is hinged to the rear end of the tube on the right side. The block of the 1902 model has two threaded and two slotted sectors and the block of the 1904 and 1905 models which have identical breech mechanisms, has four threaded and four slotted sectors. The breechblock is operated

3 Inch Gun Carriage, Model of 1902.

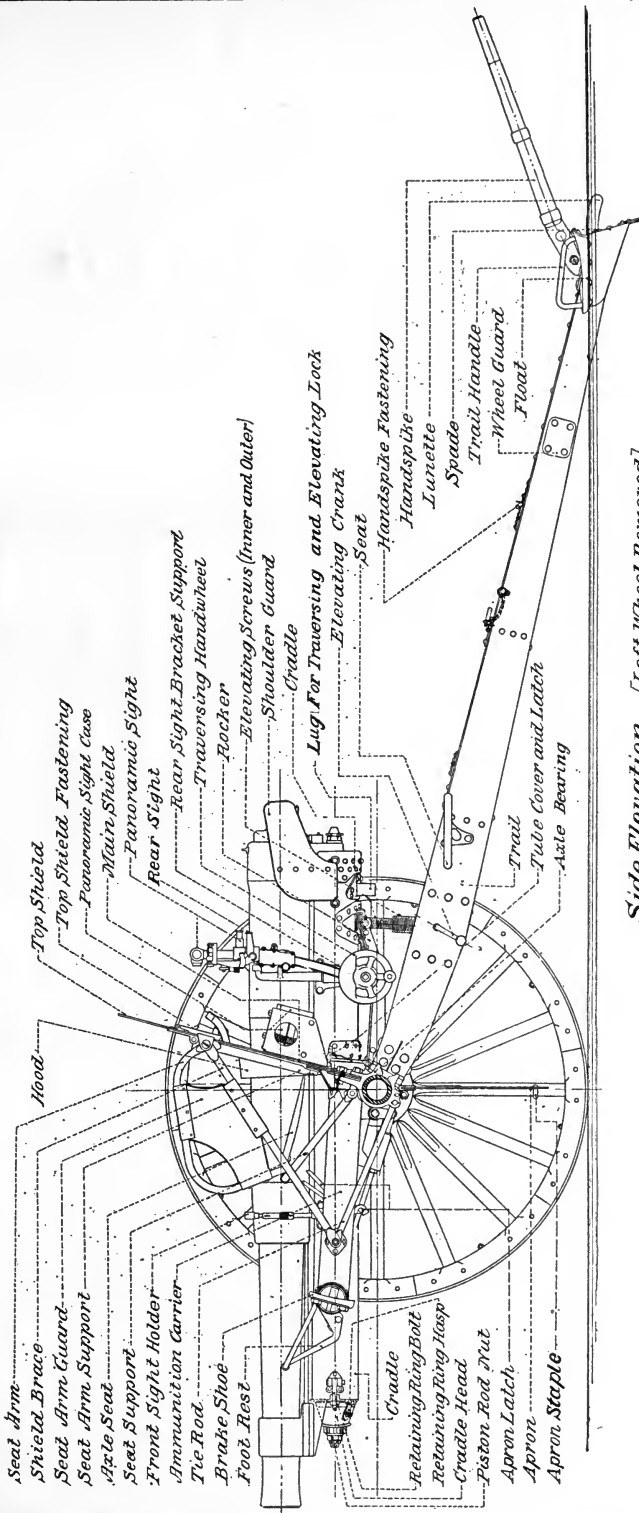

Side Elevation [Left Wheel Removed]

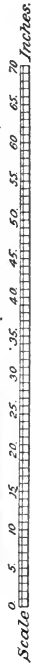

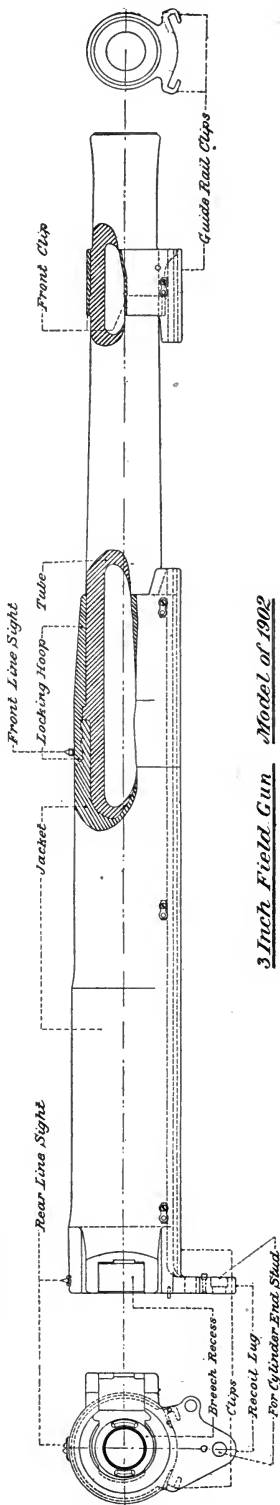

3 Inch Field Gun Model of 1902

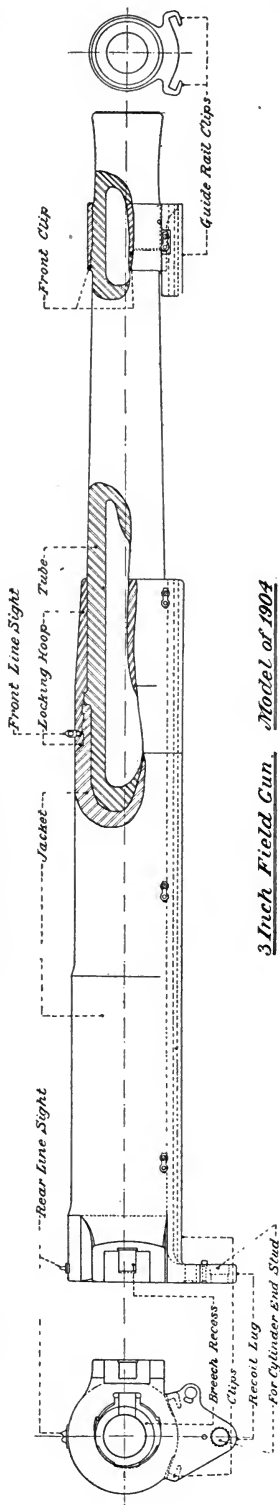

3 Inch Field Gun Model of 1904

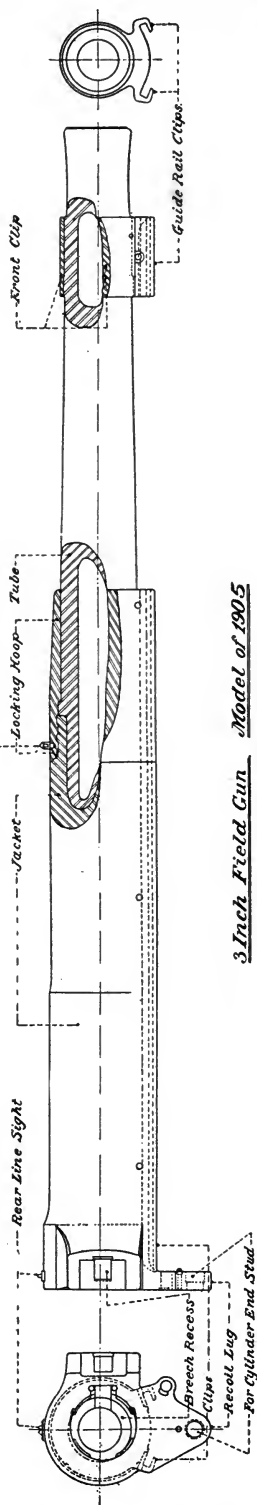

3 Inch Field Gun Model of 1905

Scale: 0 1 2 3 4 5 6 7 8 9 10 11 12 13 14 15 16 17 18 19 20 Inches

3 Inch Field Gun, Models of 1904 & 1905.

Breech Mechanism Assembled.

0 1 2 3 4 5 6 7 8 9 10 Inches

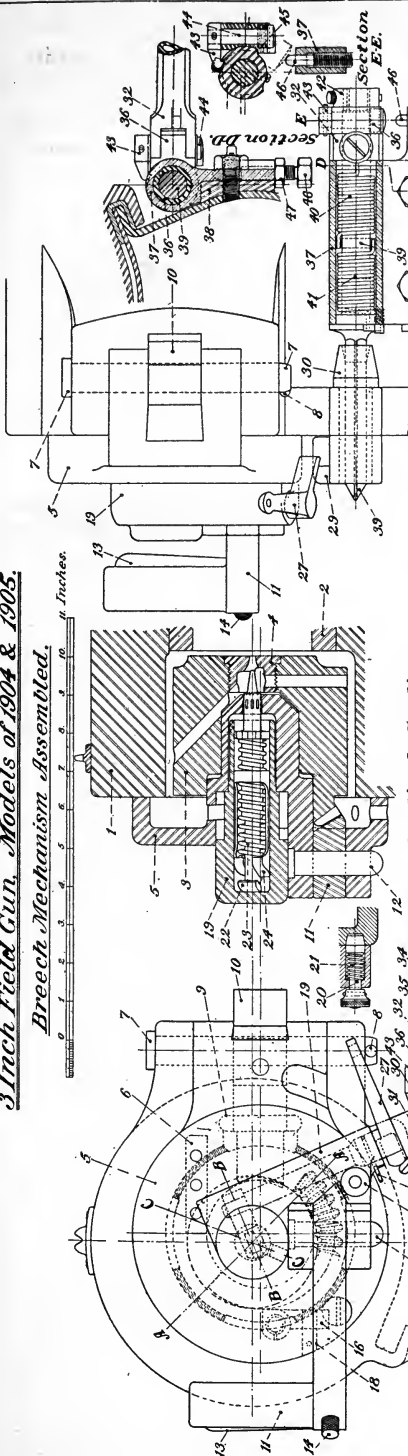

Vertical Section.

Rear Elevation.

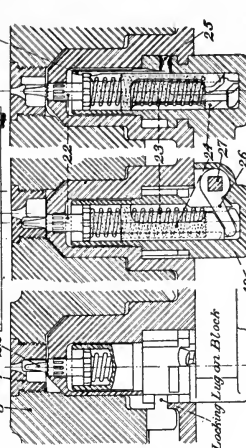

Side Elevation.

No.	Name of Part	No.	Name of Part
1	Jacket	26	Trigger Fork
2	Tube	27	Trigger-Shaft
3	Breech Block	28	Trigger-Shaft Detent
4	Vent Bushing	29	Firing Pinlet
5	Block Carrier	30	Pallet Shank
6	Block Stop	31	Pallet Pin
7	Hinge Pin	32	Firing Handle Plug
8	Hinge Pin Catch	33	Firing Handle Spring
9	Extractor	34	Firing Handle Plugger
10	Extractor Lever	35	Firing Handle Tab
11	Operating Lever	36	Firing Handle Bracket
12	Lever Pivot	37	Firing Handle Seat
13	Lever Latch	38	Bracket Seat
14	Lever Latch Pivot	39	Handle Return Spring
15	Lever Latch Spring	40	Handle Return Spring
16	Block Latch	41	Start Return Spring
17	Block Latch Spring	42	Tripping Collar
18	Block Latch Pivot	43	Trip Latch
19	Firing Lock Case	44	Trip Latch Plugger
20	Locking Bolt Nut & Pin	45	Trip Latch Spring
21	Locking Bolt Spring	46	Adjusting Screw
22	Firing Pin	47	Cheek Nut
23	Firing Pin Spring		
24	Firing Spring Sleeve		
25	Seal		

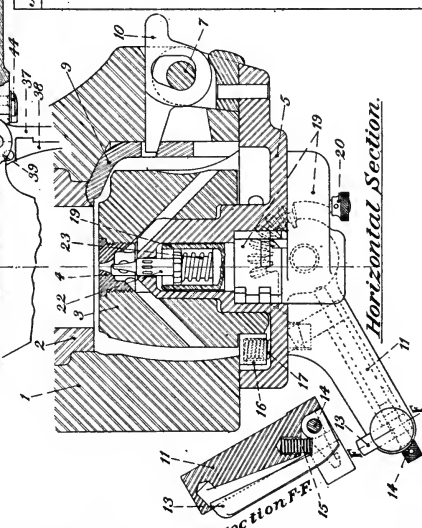

Horizontal Section.

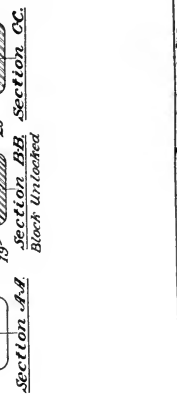

Section A-A Block Locked
Section B-B Block Unlocked
Section C-C Block Unlocked

U.S. PAT. OFF. 15-7-1915

by a lever pivoted to a lug on the block carrier which has at its outer end a handle and at its pivot end, a segment of a bevel gear, meshing with a corresponding segment on the rear face of the block. On pulling the handle to the right, the first 117° rotates the block until the threaded sectors are disengaged. A further movement of 90° swings the block and carrier on its hinge until free of the bore.

The firing pin is eccentrically located in a recess in the block, when the breech is open. As the breech is closed the pin is automatically moved to one side until it is in alignment with the axis of the bore and primer of the cartridge case. This is a safety feature which prevents the accidental discharge of a round before the breech has been fully closed.

The carriage is known as model of 1902. A tapering box-shaped trail is secured to brackets around the axle and has at its rear end a spade and float. Two compartments are provided in the trail, one for tools and one for the rear sight. A seat is riveted to each side of the trail, one on the left for the gunner, and one on the right for a cannoneer. In front of the compartments are two cross transoms which form a support for the elevating mechanism. The cradle has riveted to its underside a pintle which seats in a pintle socket secured to the axle, by means of which the cradle and gun is rotated.

The top and main shield and an apron are provided for the protection of the personnel from gun fire.

The recoil mechanism is of the hydro-spring type. The recoil cylinder is fastened to the gun lug and therefore recoils with the gun. The piston rod, being secured to the cradle head, remains stationary during recoil. Throttling during recoil is obtained by the use of three throttling bars, on the interior of the recoil cylinder, the piston having three slots cut in it to correspond to the throttling bars. During recoil the piston is stationary and the hydroline oil in the cylinder is forced past the piston through the slots. As the throttling bars, due to their increasing size, gradually close the slots in the piston, the gun is gradually brought to a stop.

The counterrecoil mechanism consists of three nests of inner and outer springs which function to return the gun to battery and serve to partially check the recoil. The counterrecoil buffer consists of a tapered rod secured in the end of the cylinder which enters the hollow end of the piston rod, displacing the oil therein and preventing shock when the gun returns to battery.

The elevating mechanism is of the double-screw type, consisting of a screw pivoted to the rear end of the rocker, which is moved up or down by the rotation of a bevel gear threaded on its interior surface. This bevel gear is rotated by a bevel pinion operated by a crank handle on either side of the trail

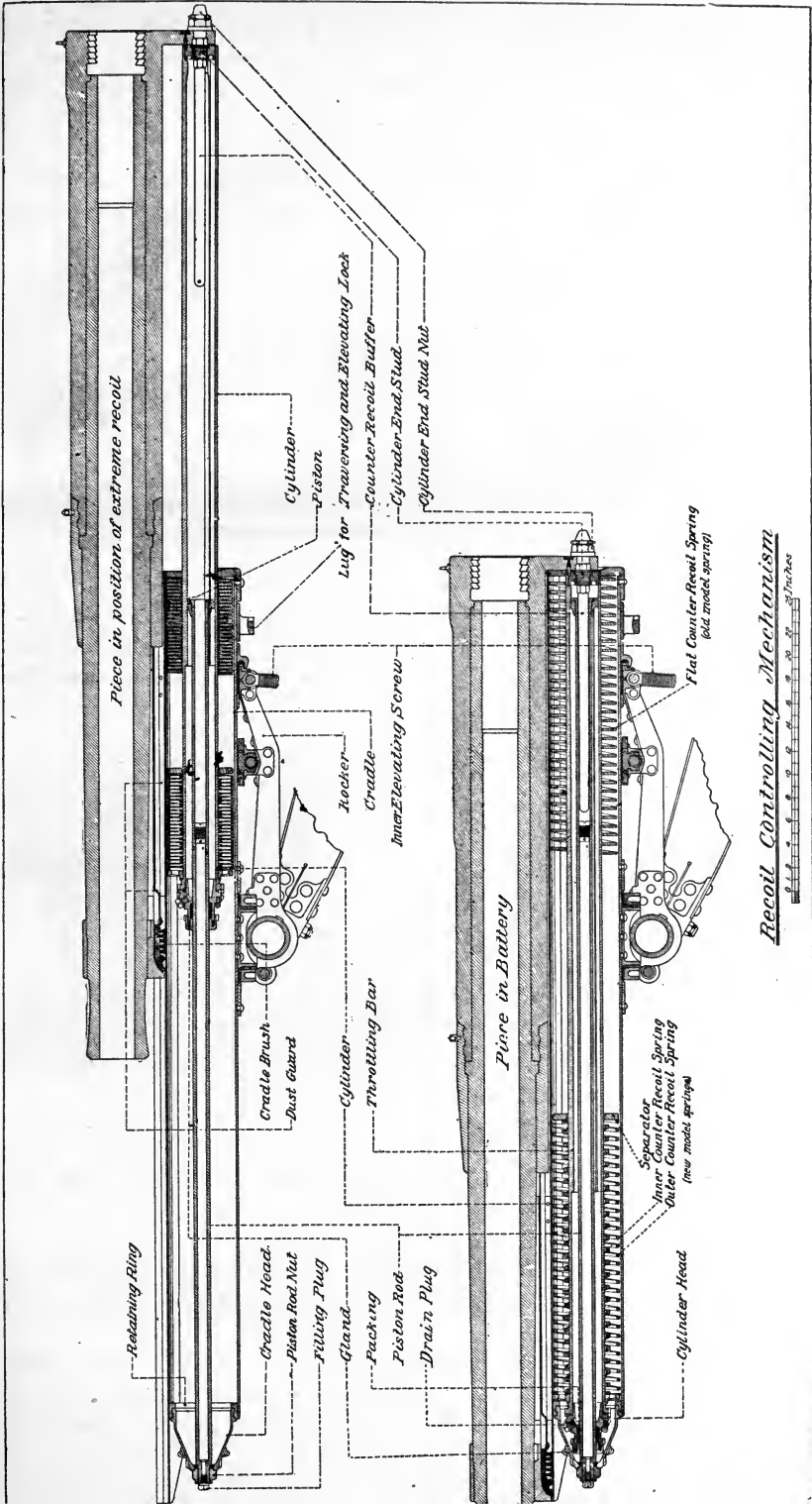

CLASSIFICATION 2-DIVISION 3

UNCLASSIFIED

Traversing is accomplished by means of a traversing shaft operated by a handwheel on the left side of the carriage. This shaft is threaded and passes through a nut which is pivoted to the cradle. The nut being secured to prevent its turning, swings the cradle in traverse, when the traversing mechanism is operated.

A lock is provided for locking the cradle to the trail in order to relieve the elevating and traversing mechanisms of any unnecessary strains during traveling.



CARRIAGE AND LIMBER HAULED BY TRACTOR.

Seats are supported on the axle on each side of carriage in front of the shield for the cannoneers, when traveling. Foot rests are provided which also support the brake levers and ammunition carriers, there being four of the latter which make it possible to open fire quickly if necessary.

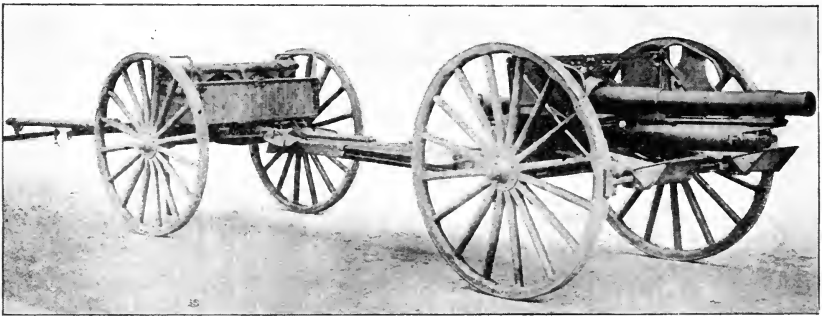

CARRIAGE AND LIMBER IN TRAVELING POSITION.

The brakes are of the shoe type and may be operated from either in front or rear of the shield, in the former case when traveling, and in the latter case when in firing position.

Standard 56-inch wheels are used. See page 158.

The instruments provided for sighting and laying the piece include line sights, a rear sight, a front sight, a panoramic site, and a range quadrant.

Three kinds of fixed ammunition are used in the 3-inch gun, models of 1902, 1904, and 1905, namely, common steel shell, common shrapnel, and high explosive shrapnel. Each round is issued with

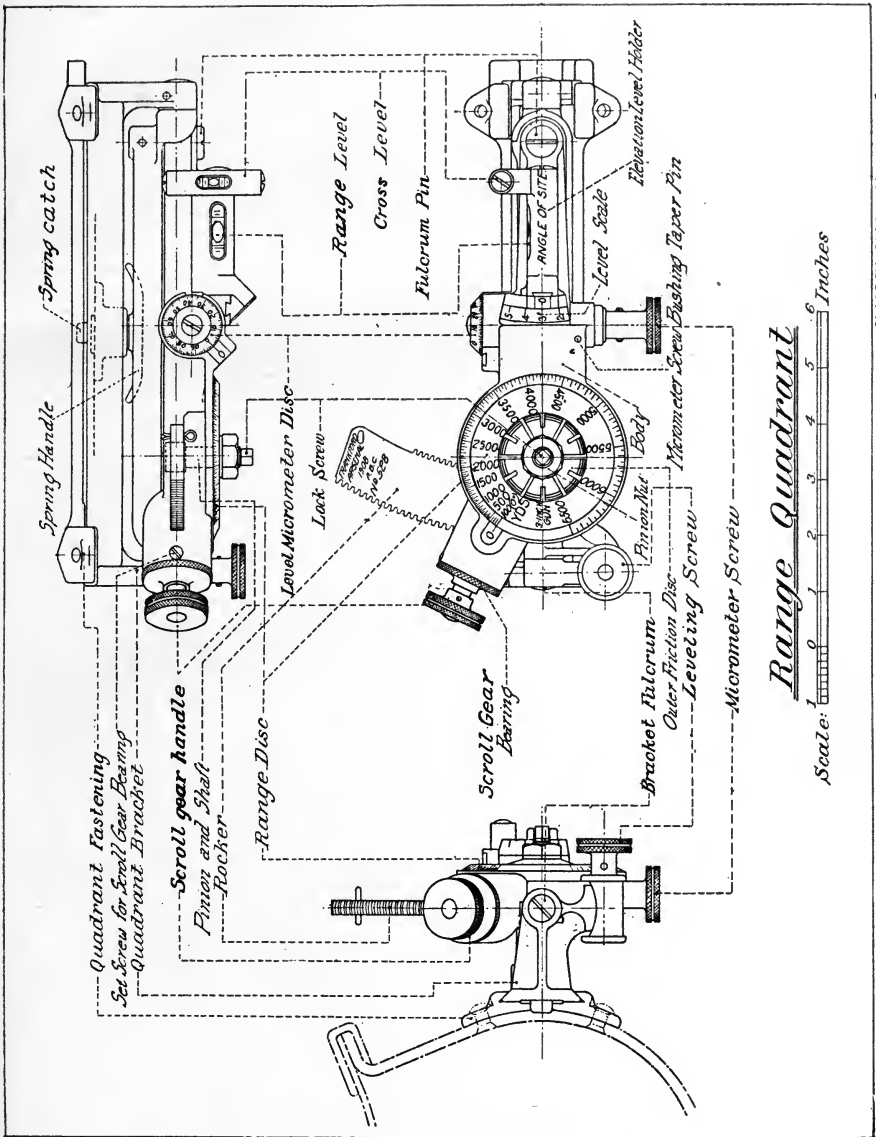

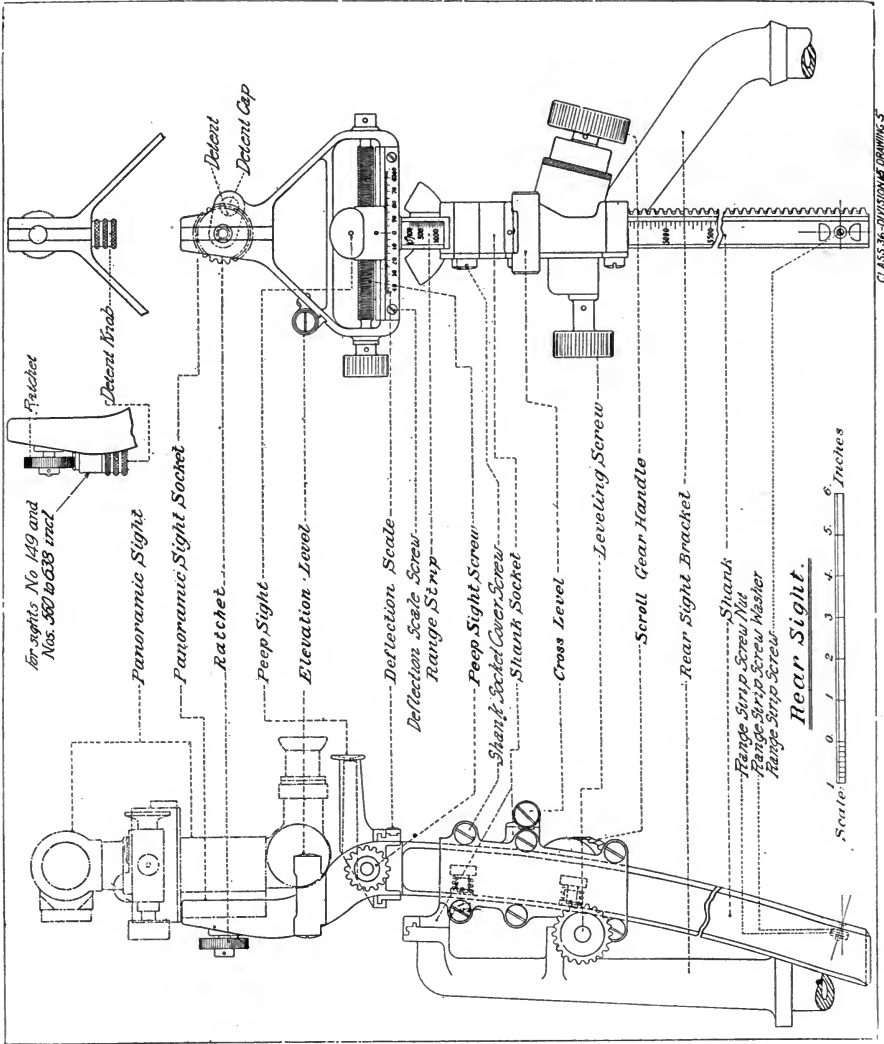

projectiles filled and fuzed. The weight of the projectile is 15 pounds and the total weight of one round is 18.75 pounds.

3-INCH GUN MATÉRIEL, MODEL OF 1902.

This matériel includes the following:

3-inch field gun, model of 1902, 1902 or 1905 mounted on carriage, model of 1902.

3-inch gun limber, model of 1902 and 1916.

3-inch gun caisson, model of 1902 and 1916.

Forge limber, model of 1902 and 1902 M1.

Battery wagon, model of 1902, 1902 M1 and 1917.

Store limber, model of 1902 and 1902 M1

Store wagon, model of 1902, 1902 M1 and 1917.

Battery reel, model of 1917.

The above matériel is entirely of American design and manufacture.

3-INCH GUN LIMBER, MODEL OF 1902.

The limber, excepting the spokes and felloes of the wheels, is of metal throughout. The principal parts are the wheels, axle, frame, ammunition chest, pole, doubletree, singletrees, and neck yoke.

The wheels and wheel fastenings are the same as, and interchangeable with, those used on the carriage. The axle is hollow, of a single piece of forged steel, the axle body being provided with lugs, to which the middle and side rails of the frame are riveted.

The side rails are of channel shape, divided at the front, one branch being led forward and secured to the middle rail near the pole seat,

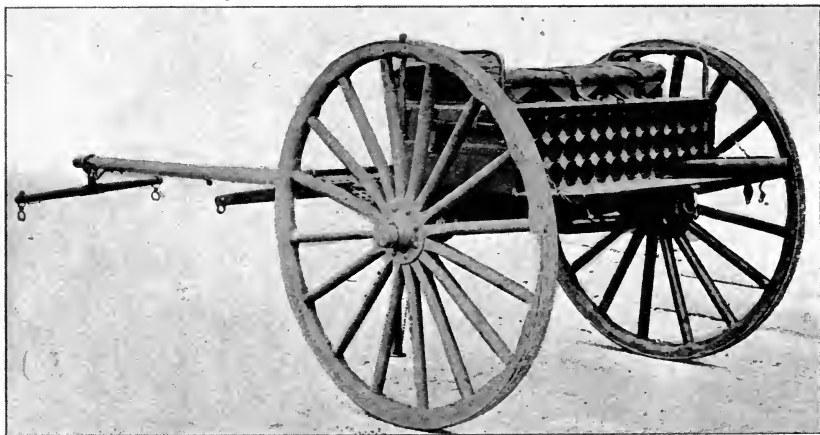

REAR VIEW OF LIMBER.

while the other branch is utilized as a foot-rest support. The foot rest is a perforated steel plate formed to shape and riveted to the middle and side rails in front of the ammunition chest. The rear ends of the side rails project slightly beyond the chest to form steps for the use of the cannoneers in mounting.

The frame consists of a middle and two side rails riveted to the axle lugs. The middle rail is in the form of a split cylinder, one-half passing below and the other half above the axle, which are joined in front to form a seat for the pole and in rear to form a seat for the pintle bearing. The pintle bearing is of bronze, made in halves and bored out to take the pintle shank. The pintle has a swiveling motion of 360° upon its shank, but is kept in its normal position by the spring in the bearing.

The doubletree and singletrees are formed of flange steel. Two doubletree rods each from the ends of the doubletree to the tie-rod

clamps on the axle to which they are pinned. A pole prop is hinged to the rear end of the pole and when not in use it is secured by fastenings under the limber frame and the prop-chain button on the foot rest.

The ammunition chest is a rectangular steel box built up of sheet steel and riveted together. The chest door is hinged at the bottom and swings downward and to the rear to an approximately horizontal position, where it is held by two door chains, and is held in its closed position by a shot bolt at each of the upper corners and by a lock in the middle.

Inside of the chest the cartridges are supported by three vertical diaphragms, flanged all around and riveted to the body of the chest. Each of the diaphragms is perforated with 39 flanged holes. Corresponding holes in the middle and rear diaphragms are connected by conical brass tubes, which are cut away on top to reduce weight. These connecting pieces support the front end of the cartridge case and enable empty cases to be carried. The rear end of the connecting piece is turned over the rear face of the flange of the perforation in the rear diaphragm, and forms a stop for the rim of the cartridge case. The chest door closes against the head of the case so that the cartridge is firmly held in position. Suitable finger clearances are cut in the flange of each cartridge hole in the rear diaphragm to enable the fingers to get a good hold on the rim of the case in withdrawing it from the chest.

Seats for three cannoneers are provided and the paulin issued with each limber serves as a seat cushion. Watering buckets are carried in suitable compartments provided for them between the seat and the chest. At each end of the seat is a handrail which projects above the top of the chest. At the front a lantern and two picket ropes are carried. Brackets for carrying an ax, a shovel, and pole prop are provided under the limber. All of the implements are secured in their brackets by leather straps, and held by strap fasteners provided for that purpose. With each limber are issued three oil cans, each of the general form of a cartridge and of a capacity of approximately two-thirds of a gallon. They are intended for hydro-line, lubricating, and coal oil, and are to be carried inside the chest in the central vertical row of cartridge holes.

Weights, dimensions, etc.

Weight, complete, empty.....	pounds..	964
Weight of tools and equipment carried.....	do....	101
Weight of ammunition carried.....	do....	675
Weight, completely equipped and loaded.....	do....	1,740
Rounds of ammunition carried in limber chest.....		36
Diameter of wheels.....	inches..	56
Width of track.....	do....	60
Free height under limber.....	do....	22
Turning angle with carriage.....	degrees..	80
Turning angle with caisson.....	do....	75

3-INCH GUN CAISSON, MODEL OF 1902.

This caisson, with the exception of the spokes and felloes of the wheels is of metal throughout.

The frame is diamond-shaped and composed of two channel section side rails riveted to lugs on the axle and meeting in front and rear at the lunette and pintle, respectively.



FRONT VIEW OF CAISSON.

The ammunition chest is a rectangular steel box of flange steel containing three vertical diaphragms which support 70 rounds of ammunition. Caissons having serial numbers 1141 to 1284, inclusive, have provisions for but 56 rounds.

The door of the chest is in the rear and hinged at the top, the door opening upward and held at each end by a prop.

An apron of armor plate is hinged under the axle and may be secured in a horizontal position for traveling.

A fuze-setter bracket is pivoted to the apron hinges on the right side of the carriage at the rear. It is raised and secured for traveling.

The road brake is designed similar to that of the gun carriage, with all parts as far as possible being interchangeable. The standard 56-inch wheels are used.

Weight, dimensions, etc.

Weight, empty.....	pounds..	1,424
Weight of tools and equipment carried.....	do....	84
Weight of ammunition carried.....	do....	1,312.5
Weight, completely loaded and equipped.....	do....	2,820
Rounds of ammunition carried.....		70
Diameter of wheels.....	inches..	56
Width of track.....	do....	60
Free height under caisson.....	do....	22.5
Turning angle.....	degrees..	75

3-INCH GUN CAISSON, MODEL OF 1916.

The frame consists of two side rails and a middle rail braced by tie rods, and by the ammunition chest to which they are riveted.

The chest is a rectangular flange steel box containing three vertical diaphragms supporting 70 rounds of ammunition.

The door is hinged to the front of the chest, swings upward on its hinges and is held by a door prop on the left side.

An apron of armor plate is hinged below the chest for the protection of the personnel.

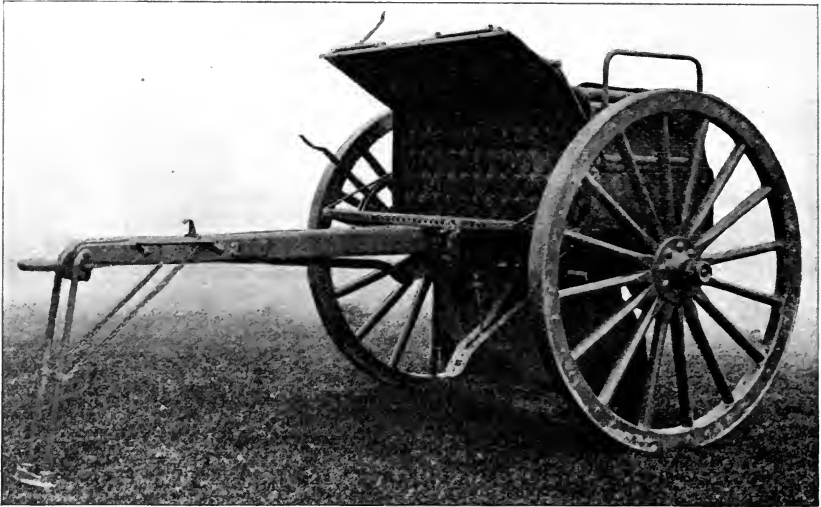

FRONT VIEW, SHOWING DOOR SWUNG UPWARD EXPOSING AMMUNITION.

Band brakes are used similar to those on the 75-mm. gun carriage, model of 1916, several parts of which are interchangeable. Brakes are applied by a hand lever on the right side, operated by one of the cannoneers seated on the chest.

Weights, dimensions, etc.

Overall length (traction pole removed).....	inches..	*64
Overall width.....	do....	*74
Overall height.....	do....	*57
Weight, empty.....	pounds..	1, 384
Weight of tools and equipment carried.....	do....	53. 5
Weight of ammunition carried.....	do....	1, 312. 5
Weight, completely equipped and loaded.....	do....	2, 750
Rounds of ammunition carried.....	do....	70
Diameter of wheels.....	inches..	56
Width of track.....	do....	60
Free height under caisson.....	do....	21
Turning angle.....	degrees..	81

*Approximately.

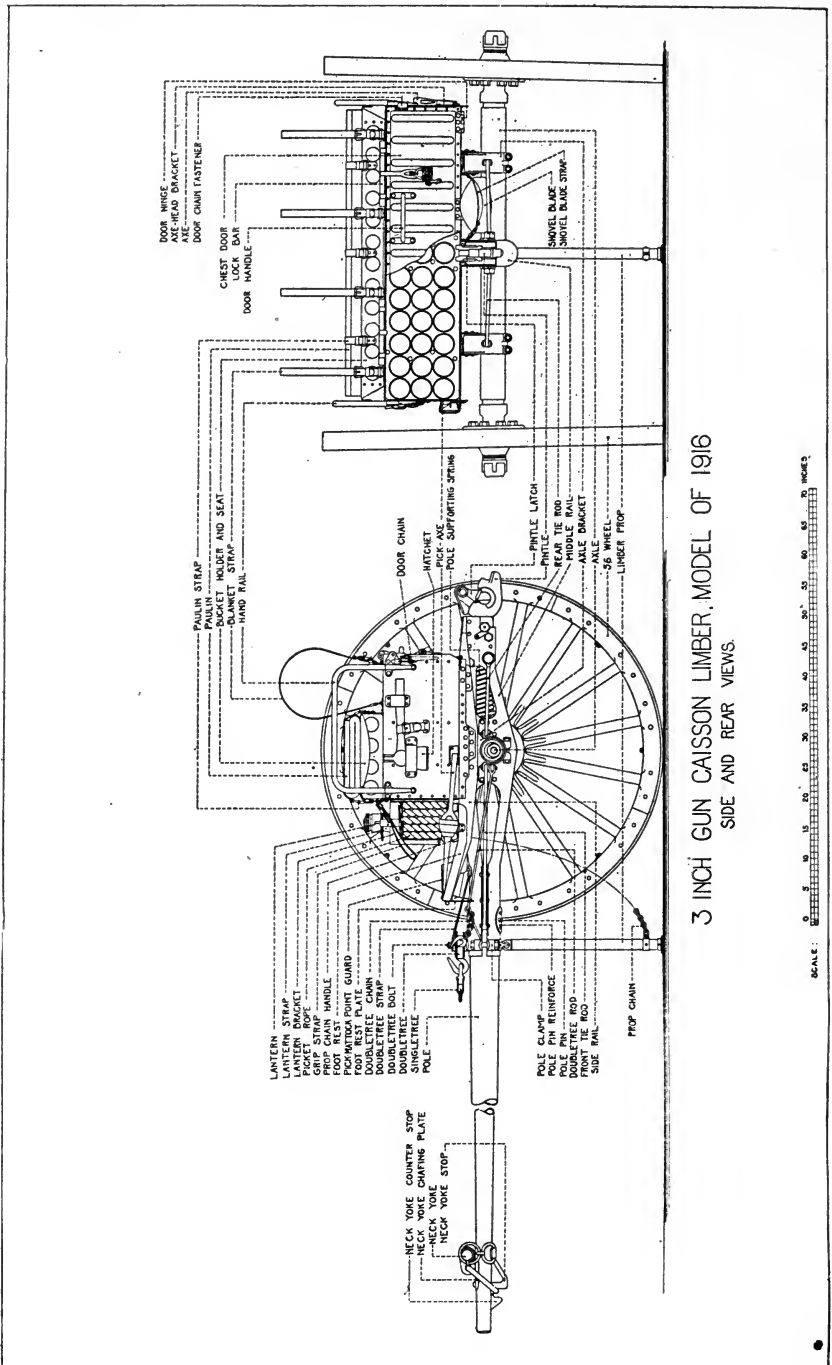

3 INCH GUN CAISSON LIMBER, MODEL OF 1916
 SIDE AND REAR VIEWS



3-INCH GUN LIMBER, MODEL OF 1916.

With the exception of the chest, the limber is the same as the 75-millimeter gun caisson limber, model of 1918. The main difference in the chest is in the size of the holes in the diaphragms, they being larger to accommodate 3-inch ammunition.

Weights, dimensions, etc.

Overall length	inches..	* 120
Overall width.....	do....	* 74
Overall height.....	do....	* 63
Weight, complete, empty.....	pounds..	987
Weight of tools and equipment carried (oil cans filled).....	do....	113
Weight of ammunition carried.....	do....	675
Weight, completely equipped and loaded.....	do....	1, 775
Rounds of ammunition carried in limber chest.....	do....	36
Diameter of wheels.....	inches..	56
Width of track.....	do....	60
Free height under limber.....	do....	24
Turning angles with carriage.....	degrees..	80
Turning angle with caisson.....	do....	81

* Approximately.

BATTERY WAGON, MODEL OF 1902.

The frame consists of two side rails joined at the front to form a seat for the lunette bracket and projecting directly to the rear beyond the axle. A forge vise is securely fastened to the left side of the frame in place of the handle.



REAR VIEW OF BATTERY WAGON.

The chest is of wood and is bolted to the side rails. The interior is divided into four compartments; the largest being accessible through a hinged lid at either end of the top. The other three compartments are in the lower rear portion of the chest, and are entered by a door at the rear end which opens downward. Of the three compartments, the right one is for the saddler's chest; the left one for the carpenter's chest, and the middle one for the cleaning materials and small stores chest. In the larger compartment is carried the grindstone and frame; the jackscrew; and the packing chest containing spare breech mechanism. A chest for spare sights is furnished, which may be carried either in the battery or store wagon.

In rear of the axle and under the chest are carried three oil cans of 5 gallons capacity each.

Fastenings are provided on either side of the chest for carrying the two spare wheels.

The wheels used and carried are standard 56-inch. See page 158.

This battery wagon is used only in connection with the 3-inch gun matériel, model of 1902.

Weights, dimensions, etc.

Weight of battery wagon, empty.....	pounds..	1,244
Weight of battery wagon, completely equipped and loaded.....	do....	2,747
Diameter of wheels.....	inches..	56
Width of track.....	do....	60
Free height under wagon.....	do....	26
Turning angle.....	degrees..	75

BATTERY WAGON, MODEL OF 1902 MI.

The battery wagon, model of 1902 MI, differs from the model of 1902 in the following respects:

The chest with attachments is stronger, better braced, and attached in a better manner to the frame.

The weight of the spare wheels is carried directly by the axle instead of at the top of the chest.

The parts of the chest are bolted and screwed together so that they may be readily disassembled if necessary. The corners are not dovetailed but reinforced with corner irons inside and out.

This battery wagon is used only in connection with the 3-inch gun matériel, model of 1902.

Weights, dimensions, etc.

Weight of battery wagon, empty.....	pounds..	1,444
Weight of battery wagon, completely equipped and loaded.....	do....	2,947
Diameter of wheels.....	inches..	56
Width of track.....	do....	60
Free height under wagon.....	do....	24.5
Turning angle with limber.....	degrees..	75
Weight (approximate) at lunette, loaded.....	pounds..	112

STORE WAGON, MODEL OF 1902.

The store wagon is the same as the battery wagon, model of 1902, with the exception that the vise is omitted and a frame handle attached in its place, and the body has but a single compartment, with two doors on top. As on the battery wagon, the store wagon carries two spare wheels and three oil-cans.

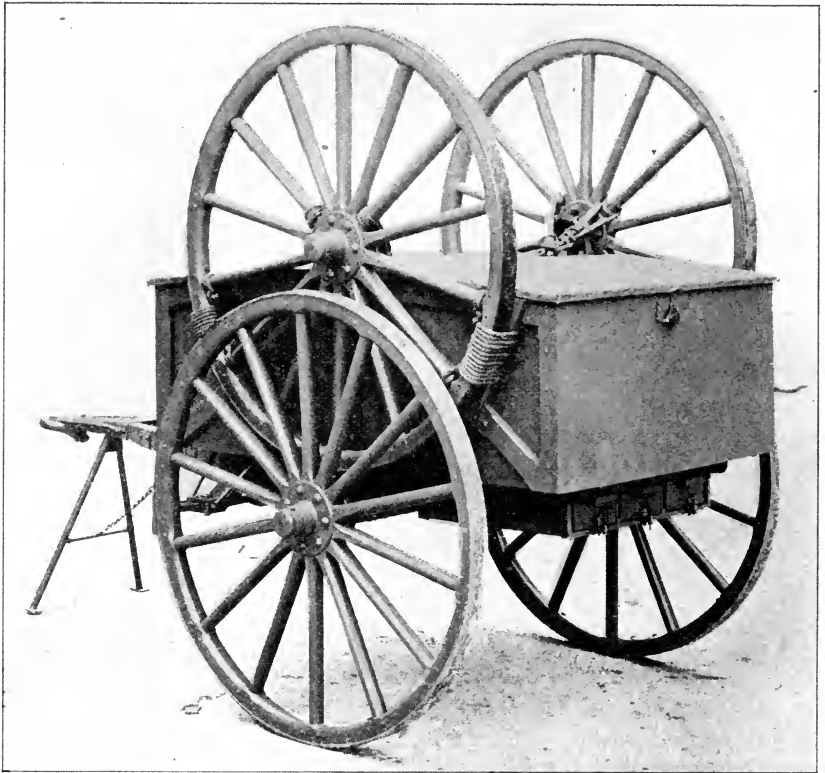

SIDE VIEW OF STORE WAGON.

The store wagon is intended primarily for carrying such stores, spare parts, and materials as can be carried in the battery wagon and, in addition, such stores as may be designated by proper authority.

Tire brakes are used operated by a hand lever on the right side of the body.

The wheels used and carried are the standard 56-inch. See page 158.

For detailed description and table of weights, dimensions, etc., see page 139.

STORE WAGON, MODEL OF 1902 MI.

The store wagon, model of 1902 MI, is the same as the battery wagon, model of 1902 MI, with the exception of the differences as noted in the description of the battery store wagon, model of 1902.

For detailed description and table of weights, dimensions, etc., see page 139.

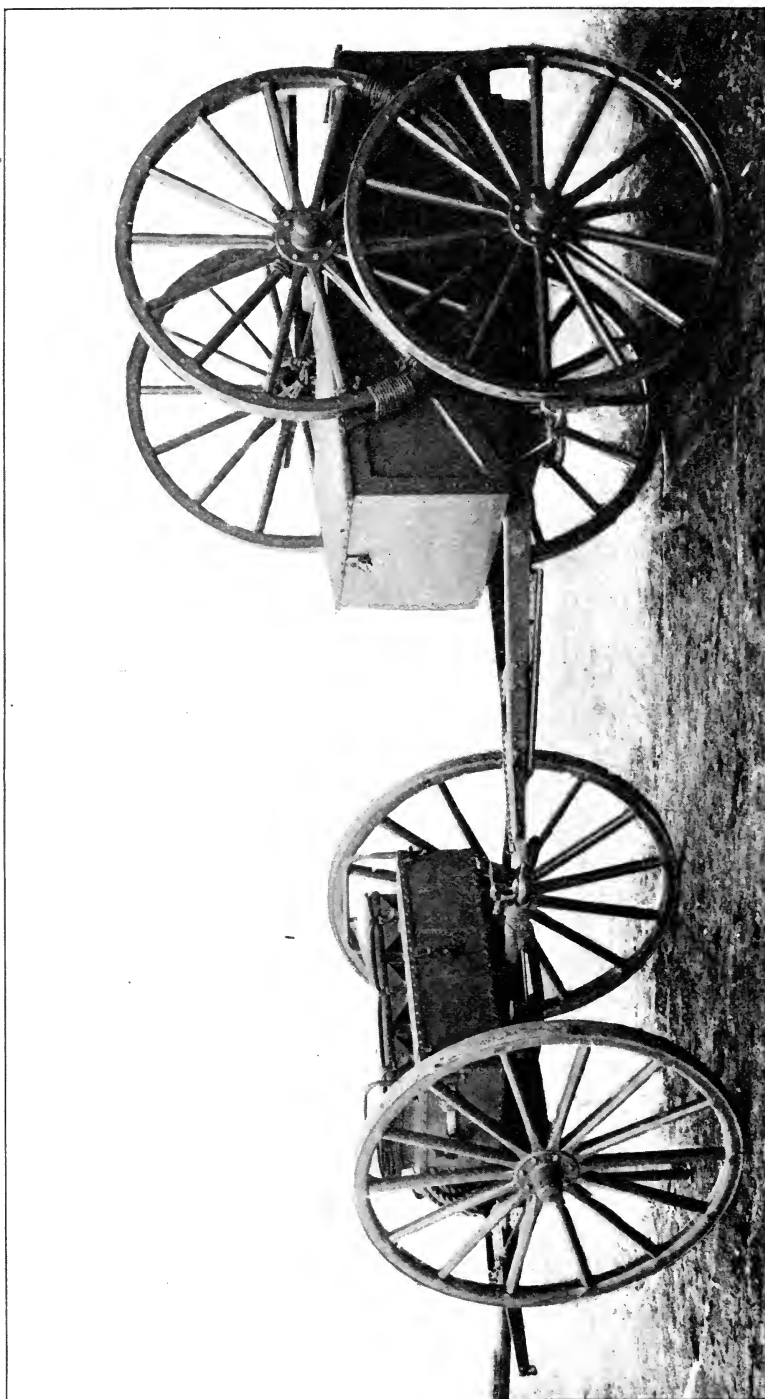

STORE WAGON AND STORE LIMBER, MODELS OF 1902, LIMBERED.

FORGE LIMBER MODEL OF 1902.

The frame of the forge limber is identical in all its parts with that of the 3-inch gun limber, model of 1902. It consists of a middle and two side rails, the middle rail being in the form of a split cylinder, one half passing below and the other half above the axle, uniting in front to form a seat for the pole and in the rear to form a seat for the pintle bearing guide.

The chest is a rectangular flange-steel box having a lid hinged along the front edge of the chest body. The lid is flanged all around,

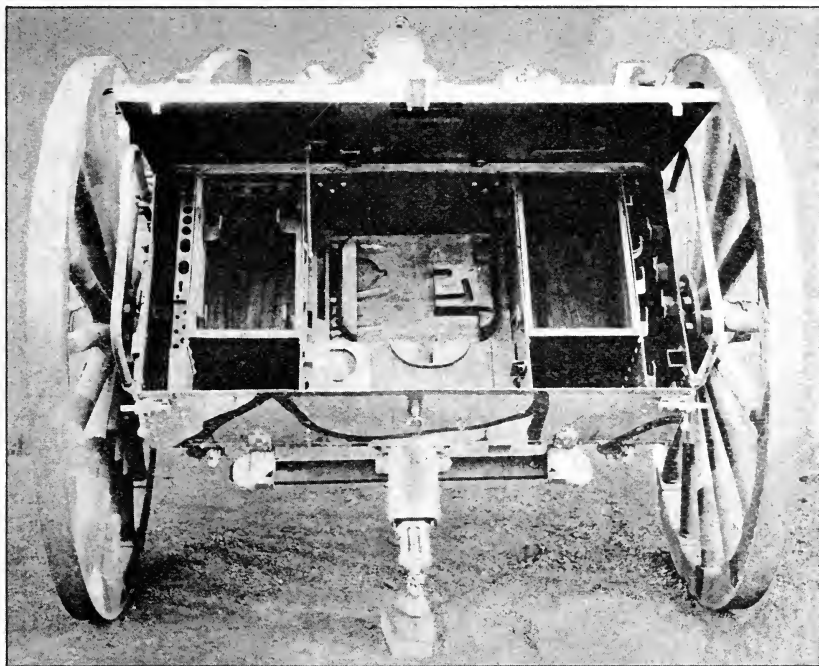

TOP VIEW SHOWING INTERIOR OF FORGE LIMBER.

fitting over the body of the chest to make it water-tight. Shot bolts on the rear face of the chest secure the lid when closed.

The interior of the chest is divided into five compartments by four vertical steel partitions. The middle compartment, which is the largest, is fitted to take the field forge, the anvil, and several small tools, the next compartment on either side carries horseshoes and horseshoe nails, and the end compartments are fitted with fastenings for carrying smiths' and machinists' tools. A tubular oil

FORGE LIMBER MODEL OF 1902 M1

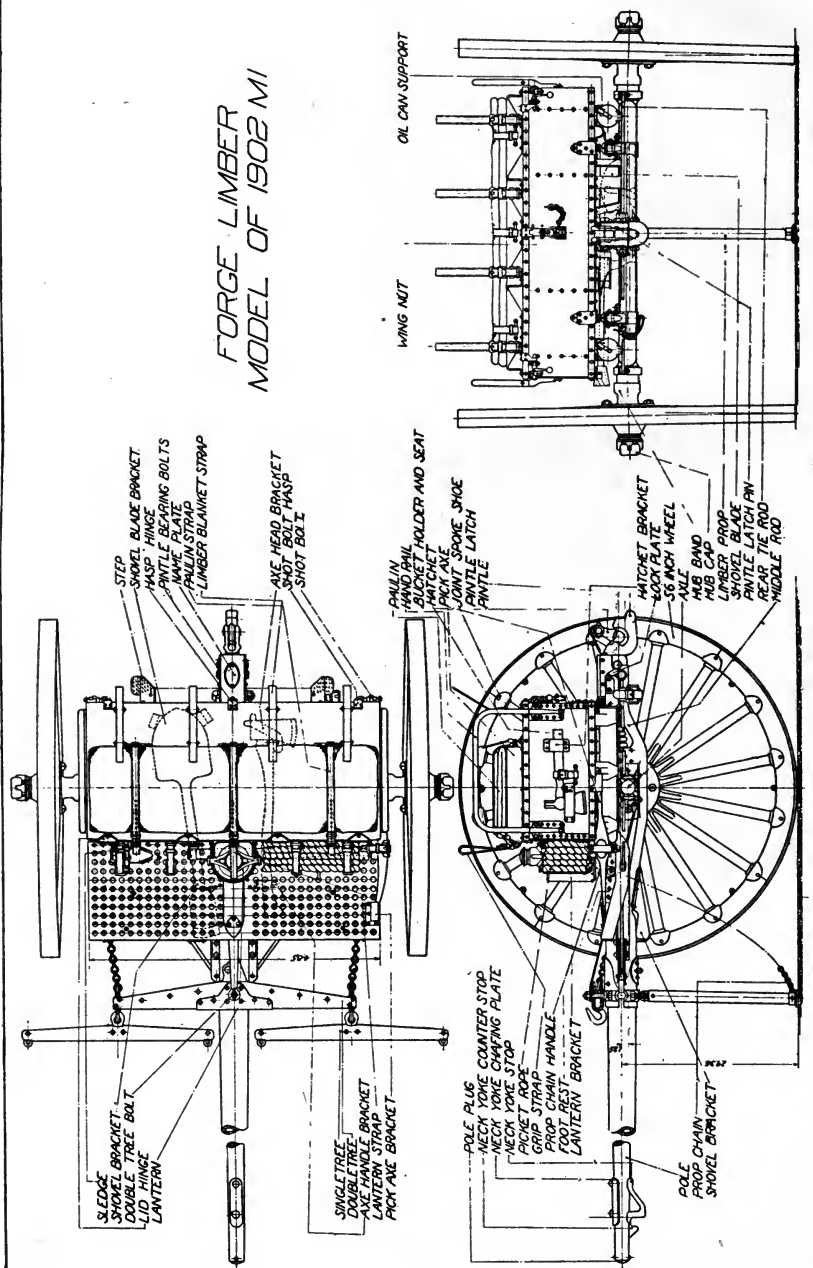

can is carried under each end of the chest, and various implements are secured to the chest by straps provided for that purpose.

Weights, dimensions, etc.

Weight of forge limber, empty, without equipment.....	pounds..	958
Weight of forge limber, complete, equipped and loaded.....	do....	1,577
Weight of store limber, empty, without equipment.....	do....	955
Weight of store limber, complete, equipped and loaded.....	do....	1,106
Diameter of wheels.....	inches..	56
Width of track.....	do....	60
Free height under limber.....	do....	26.5
Turning angle with battery wagon.....	degrees..	75

FORGE LIMBER, MODEL OF 1902 MI.

The forge limber, model of 1902 MI, is identical with the 1902 model, with the exception that the 1902 MI model has an automatic pole support, which is described on page 160.

The forge limber is used in connection with the American, British, and French 75-millimeter matériel, and the 3-inch gun matériel, model of 1902.

A detailed description and table of weights and dimensions is given in a preceding article on forge limber, model of 1902, page 143.

STORE LIMBER, MODEL OF 1902.

The store limber is practically the same as the forge limber, model of 1902, except that the chest is fitted with compartments for carrying fire-control equipment, some of the compartments being padded to protect the contents from injury.

For description and table of weights and dimensions, see preceding article on forge limber, model of 1902.

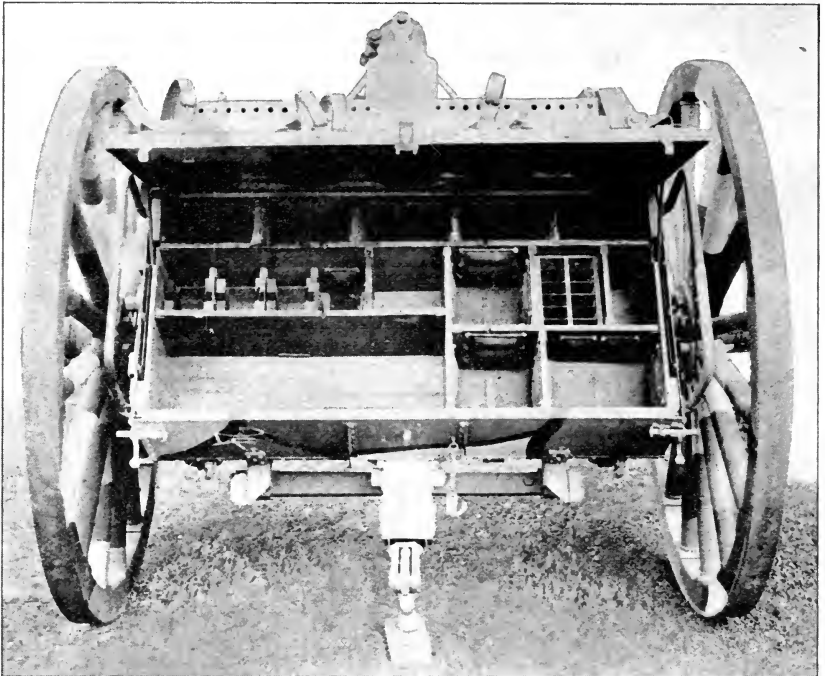

TOP VIEW SHOWING INTERIOR OF STORE LIMBER.

STORE LIMBER, MODEL OF 1902 M1.

The store limber, model of 1902 M1, is identically the same as the store limber, model of 1902, with the exception that it is fitted with an automatic pole support, description of which will be found on page 160.

For description and table of weights and dimensions, see preceding article on forge limber, model of 1902.

STORE LIMBER, MODEL OF 1902 M1.

The limber is used in connection with the American, British, and French 75-millimeter matériel, and the 3-inch gun matériel, model of 1902.

BATTERY AND STORE WAGON, MODEL OF 1917.

The battery and store wagon is made of metal throughout, with the exception of the spokes and felloes of the wheels. The frame is built up of two channel section side rails connected at the rear and intermediate points by similar channels. The side channels are bent inward near the front, meeting and forming a seat in which the

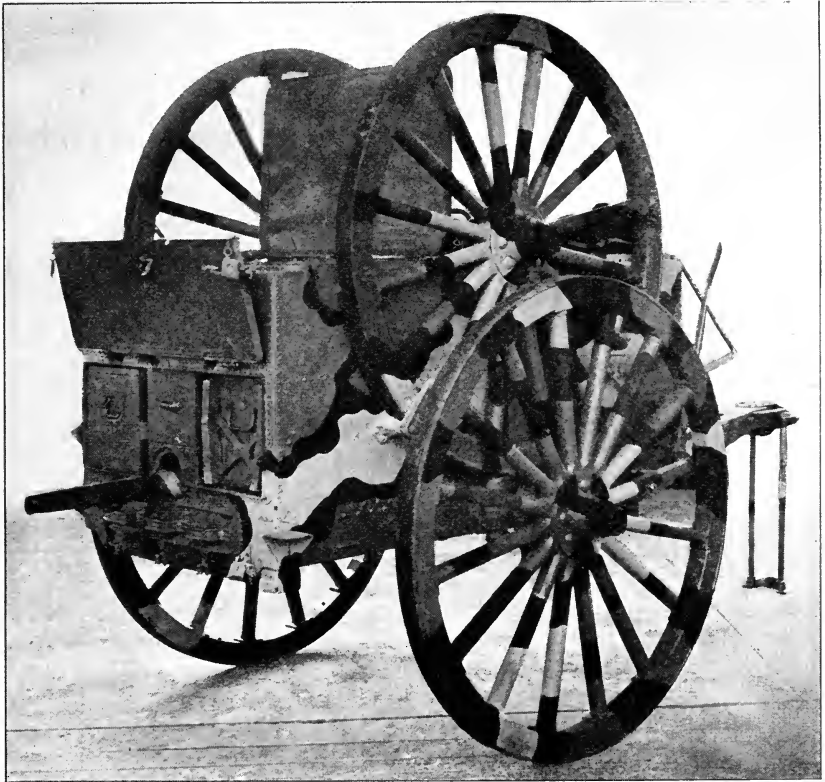

REAR RIGHT SIDE VIEW OF BATTERY AND STORE WAGON.

lunette bracket is riveted. At the rear of the frame is a compartment for carrying recuperator, lubricating, and coal oil cans.

The chest is divided into compartments for carrying various articles of battery equipment. The top compartments have horizontally hinged lids and the lower compartments in front and rear have vertical swing doors. Fastenings are provided on each side of the chest for carrying spare wheels, and provision is made for carrying a spare limber pole.

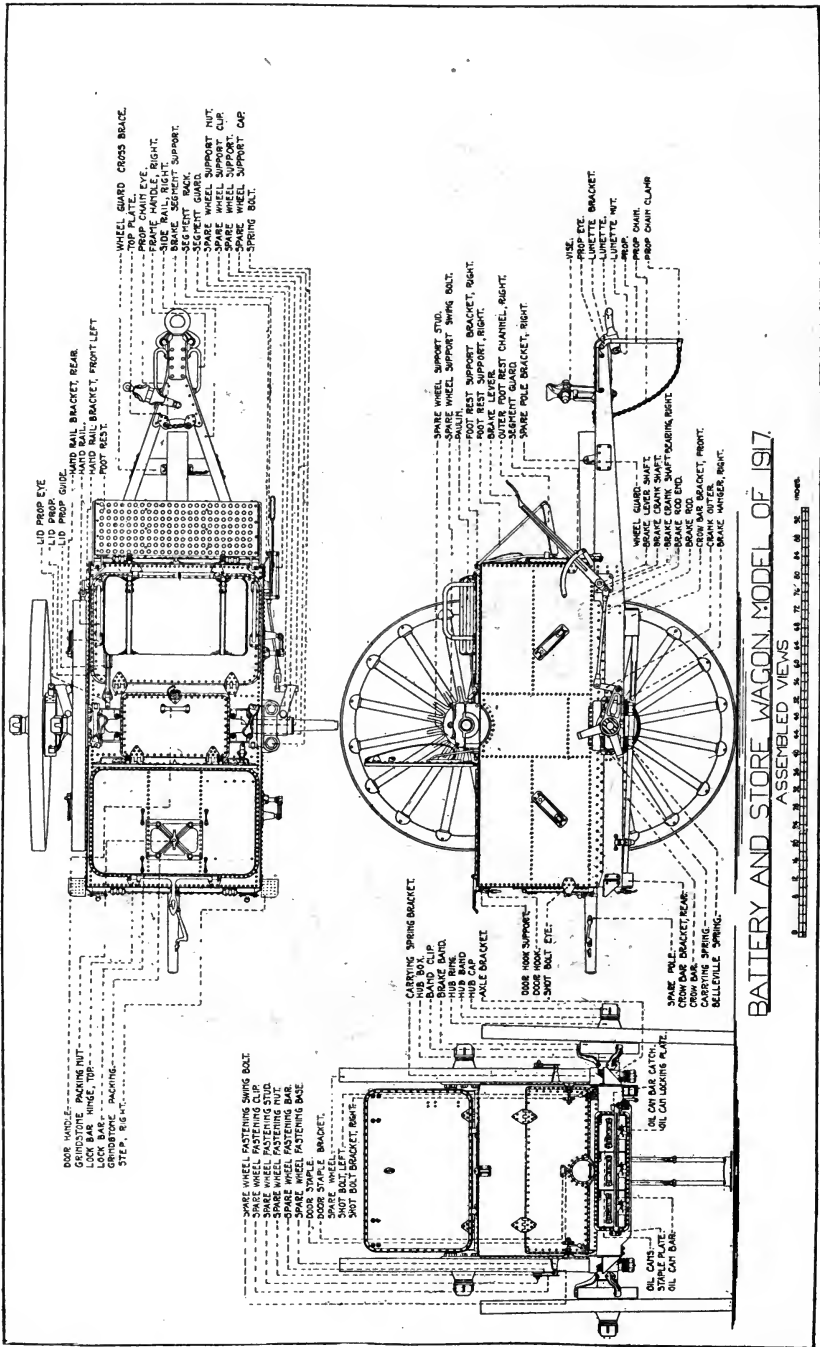

BATTERY AND STORE WAGON MODEL OF 1917
 ASSEMBLED VIEWS



The battery and store wagons are identical, except that the battery wagon carries a vise on the front end of the frame and a crowbar bracket below the frame on the right side, and the store wagon contains packing strips and accessories for carrying a grindstone in the upper rear compartment.

Standard 56-inch wheels are used. See page 158. The battery and store wagon is used in connection with the American, British, and French 75-millimeter matériel, and with the 3-inch gun matériel, model of 1902.

Weights, dimensions, etc.

Weight of battery wagon, empty.....	pounds..	1,705
Weight of battery wagon, completely equipped and loaded.....	do....	3,325
Weight of store wagon, empty.....	do....	1,705
Weight of store wagon, completely equipped and loaded.....	do....	3,590
Diameter of wheels.....	inches..	56
Width of track.....	do....	60
Free height under wagons.....	do....	24.5
Turning angle with limbers.....	degrees..	75
Weight (approximate) at lunette of both wagons, loaded.....	pounds..	112
Overall length.....	inches..	* 132
Overall width.....	do....	* 74
Overall height.....	do....	* 88

* Approximately.

BATTERY REEL, MODEL OF 1917.

The battery reel, model of 1917, is a single two-wheeled vehicle which is drawn by 4 horses. It is designed to carry, lay, and recover 4 miles of insulated cable, and in addition carries 2 steel chests containing fire-control instruments.

The frame is composed of two side rails connected by cross members and diagonal braces. Near the front, the side rails converge and are riveted to the pole socket. Axle brackets are riveted to the side rails,



LEFT SIDE VIEW OF BATTERY REEL.

in which are mounted the axle arms for the wheels and the drum shaft on which the cable drum rotates.

On each side of the drum are supports which are joined across the top by a seat for two men. Across the frame in front of the drum is secured an instrument chest divided into two compartments with separate hinged lids, the lids forming foot rests for the personnel on the seat. Across the frame in rear of the drum a large steel chest is supported on springs. It has a lid hinged at the front and provided with guide rollers for the cable at its rear. The larger fire-control instruments are carried in this chest in specially designed compartments.

On the right side of the drum is secured a steel case in which a plotting board is carried.

At either end of the drum is a sliding leather-faced cone which is controlled by a hand lever at the left end of the operator's seat. When either cone is engaged, the other is disengaged. The cone on the left is connected directly to a gear train driven by a gear attached to the wheel hub, and when engaged causes the drum to revolve. As the brake cone on the right is engaged the clutch cone is thrown out of engagement. The wire, when being laid out, leaves from the top of the drum, passing between the guide rollers attached to the rear chest.

The cart, model of 1918, together with the reel, model of 1909MI, is issued in lieu of the battery reel, model of 1917, for motorized batteries.

Weights, dimensions, etc.

Overall length (traction pole removed).....	inches..	74
Overall width.....	do....	73.75
Overall height.....	do....	65
Weight of reel (without load).....	pounds..	1,385
Weight of reel, completely equipped and loaded.....	do....	2,005
Diameter of wheels.....	inches..	56
Width of track.....	do....	60
Free height under reel.....	do....	19
Length of wire carried (approximately).....	miles..	5

REEL, MODEL OF 1909 M1.

The reel, model of 1909 M1, is a two-wheeled vehicle designed to carry, lay, and recover 8 miles of insulated cable. It has interchangeable pole connections which enable it to be adapted to either horse or motor traction.

The frame is composed of special shaped pressed steel members connected by gusset plates and reinforce pieces, the pole socket at the front, automatic pole support, a pintle at the rear, and the assembled axle.

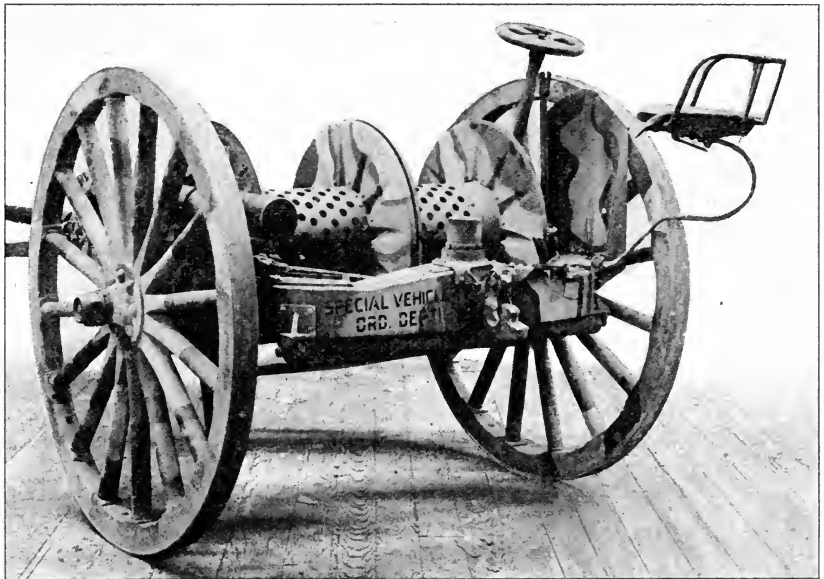

REAR VIEW OF REEL.

Two drums, which carry the cable are mounted end to end on an axle which rests in the upper ends of the axle brackets. In order to lay the wire, the drums are disengaged from the clutch, permitting them to revolve free upon their axes, but controlled by the braking action of the drum latch and drum brake or the friction clutch when applied for that purpose. To recover the cable or wind it on the drums, the clutch in the right drum is applied, and the drum made to revolve, by means of the chain driving gear attached to the right wheel. The left drum is driven by the right drum through a pin clutch which is operated by a handle in the left outer end of the left drum.

REEL, MODEL OF 1909, M1

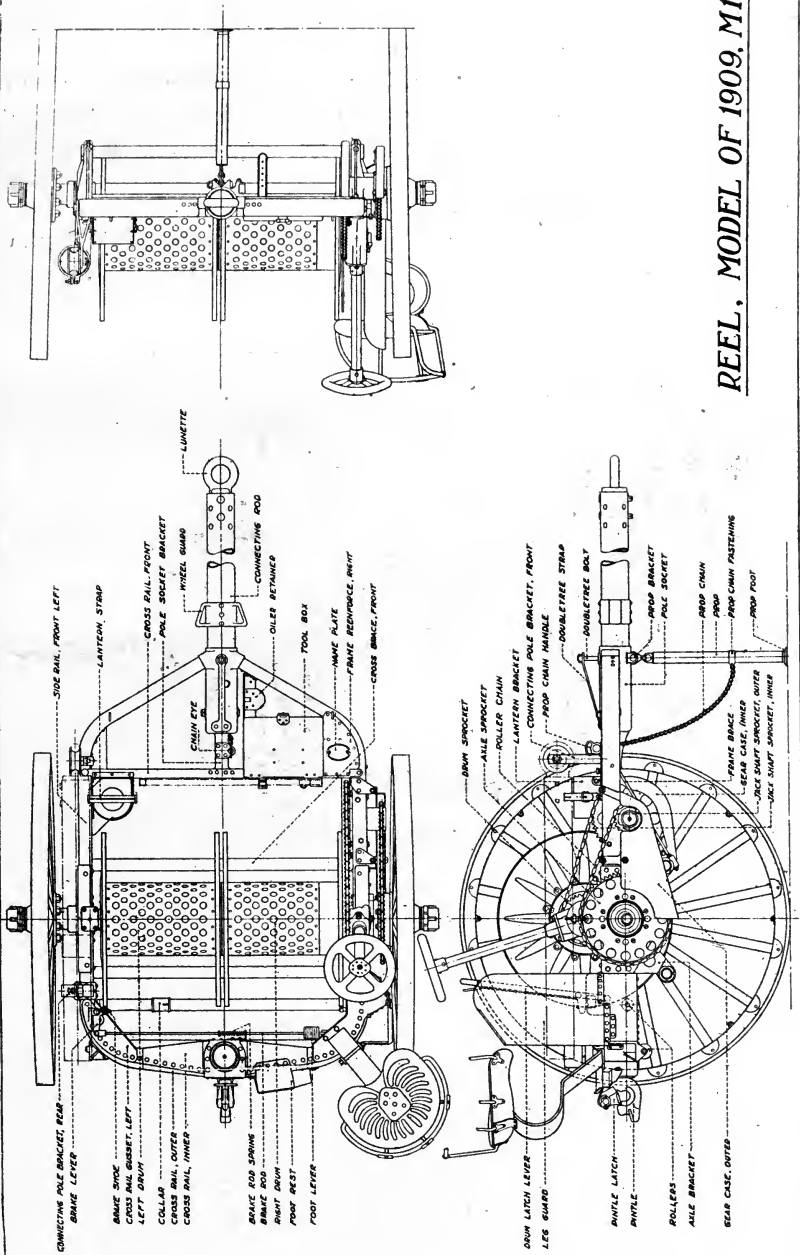

An operator's seat is secured to the right rear corner of the frame, and the controls placed within easy reach. The clutch connecting the drum driving gear and the right drum is located in a recess in the right drum head and operated by a handwheel at the upper end of a shaft mounted on the right axle bracket.

A lever on the right side near the seat operates the drum latch for locking the right drum, and through the pin clutch, the left drum when they are at rest. A leather faced brake shoe attached to the drum latch lever may be brought against the flanged rim of the right drum end plate to act as a brake.

A brake shoe controlled by a foot lever near the operator's seat may be brought to bear against the flanged rim of the left drum end plate.

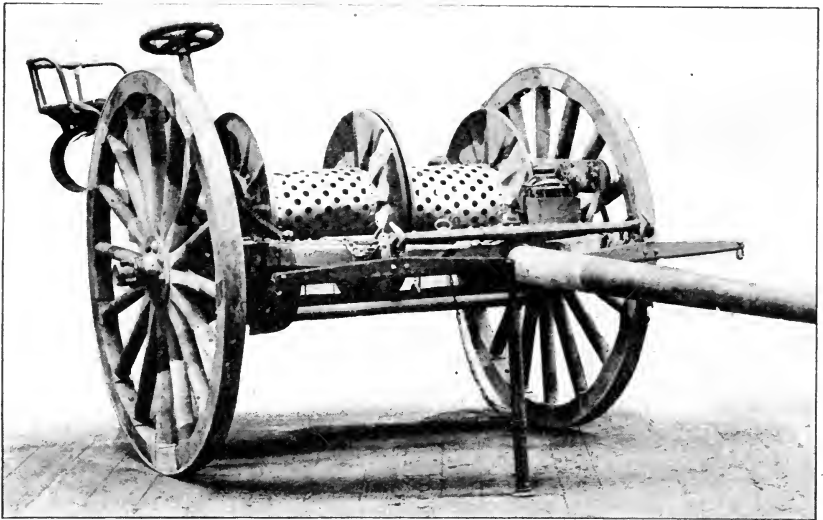

FRONT VIEW OF REEL.

Wooden rollers are placed under the frame so that the wire will be laid out or recovered without injury to it.

A tool box with lid opening on top is secured to the right of the pole bracket in the space between the side rail and front cross rail.

The reel, model of 1909 M1, together with the cart, model of 1918, is issued in lieu of the battery reel, model of 1917, for motorized batteries.

Weights, dimensions, etc.

Weight of reel (without load).....	pounds..	1, 459
Weight of reel completely equipped and loaded.....	do....	2, 426
Diameter of wheels.....	inches..	56
Width of track.....	do....	60
Free height under reel.....	do....	19
Turning angle with cart.....	degrees..	75
Length of wire carried.....	yards..	22, 880

CART, MODEL OF 1918.

The cart is a two-wheeled vehicle made of metal throughout, with the exception of the spokes and felloes of the wheels and the packing

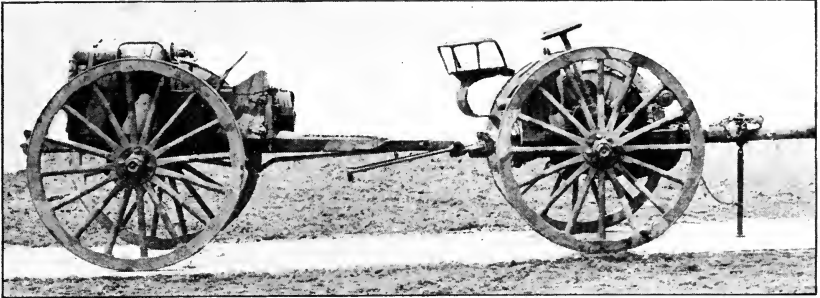

VIEW SHOWING REEL AND CART, LIMBERED.

within the chest. It is designed to carry part of the fire-control equipment for the organization to which it is issued.

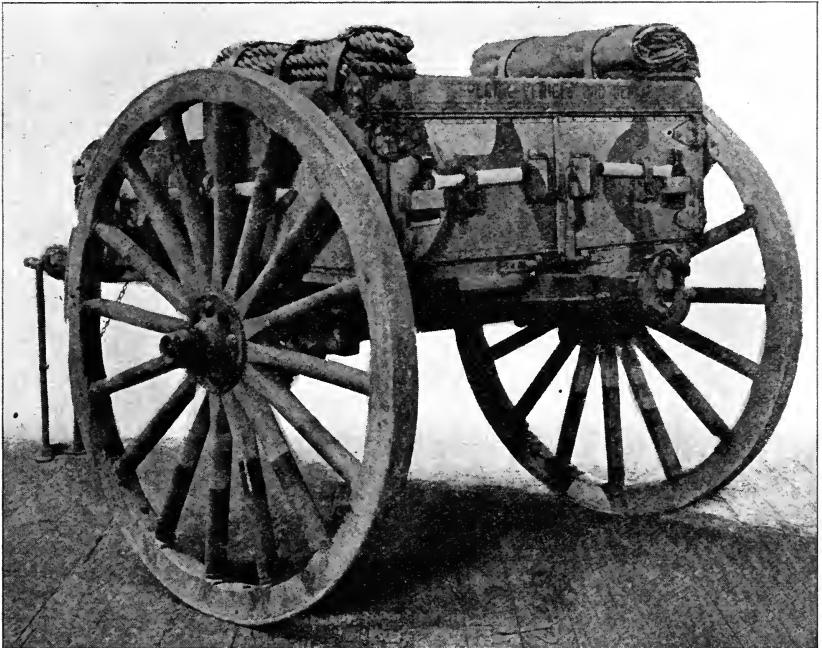

REAR VIEW OF CART.

The frame consists of a middle rail, two side rails, and two axle brackets, all of which support the chest. The forward end of the

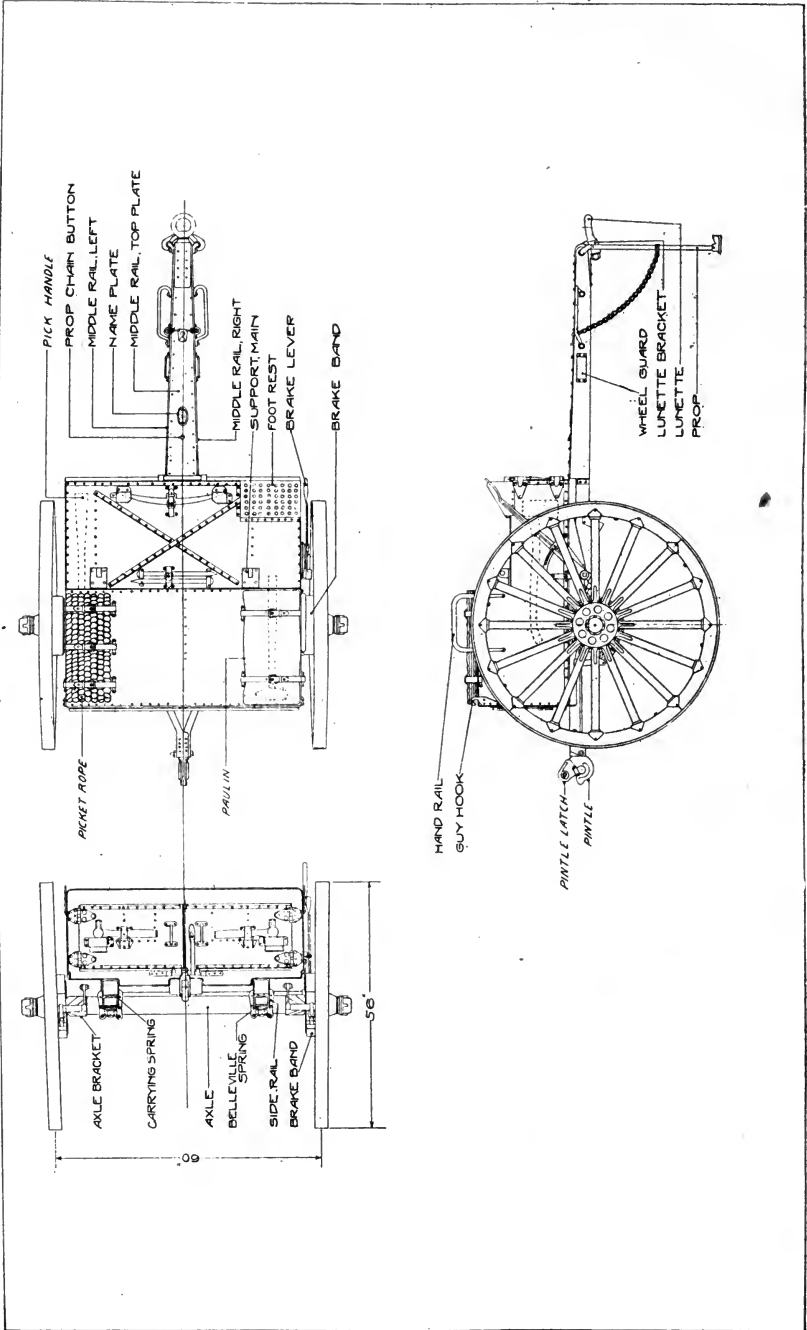

CART. MODEL OF 1918.

middle rail is fitted with a lunette and the rear end with a pintle. Spiral springs are interposed between the side rails and axle brackets to absorb the shocks when traveling. In connection with the axle brackets, Belleville springs are used to take up rebound.

The chest is made up of flange steel plates riveted together and fitted with doors, lock bars, and packing devices, the interior being divided into 17 compartments of different sizes. The chest is also furnished with fixtures on the exterior for attaching an observation tower.

The road brakes are of the contracting band type and are operated from the front of the cart or from the operator's seat on top of the chest by means of a brake lever on the right side.

This cart, together with the reel, model of 1909M1, is issued in lieu of the battery reel, model of 1917, for motorized batteries.

Weights, dimensions, etc.

Overall length	inches..	* 126
Overall width	do....	* 74
Overall height	do....	* 62
Weight, empty, without body equipment	pounds..	1, 676
Weight, complete, fully equipped and loaded	do....	2, 004
Diameter of wheels	inches..	56
Width of track	do....	60
Free height under cart (approximate)	do....	26
Turning angle with reel (approximate)	degrees..	75
Weight of instruments	pounds..	431

* Approximately.

THE 56-INCH WHEEL.

All carriages and accompanying vehicles of the 3-inch and 75-millimeter matériel, of American design, are equipped with standard 56-inch wheels, which are interchangeable for all vehicles of these matériels.

The wheel is a modified form of the Archibald pattern, 56 inches in diameter, with 3-inch tires. The tires are of steel. An oil valve is provided so that the wheel can be oiled without removing it



SIDE VIEW OF WHEEL.

The wheel fastening consists of a bronze yoke fitting in the outer end of the axle arm and is accessible when the hub cap is removed.

THE 57 BY 3.5 INCH WHEEL.

In place of the above 56-inch wheel a 57 by 3.5 inch wheel may be used.

It is similar in design to the 56-inch wheel, but is fitted with solid rubber tires.

Like the 56-inch wheel it is interchangeable on all vehicles of the 3-inch and 75-millimeter matériel.

REEL, MODEL OF 1917, FOR CAISSONS.

One caisson in every battery is provided with a hand reel for telephone wire. It is riveted to the top of the caisson and contains 1 mile of field wire so arranged that the current goes through all the wire. Terminals are provided for the connection of the instruments.

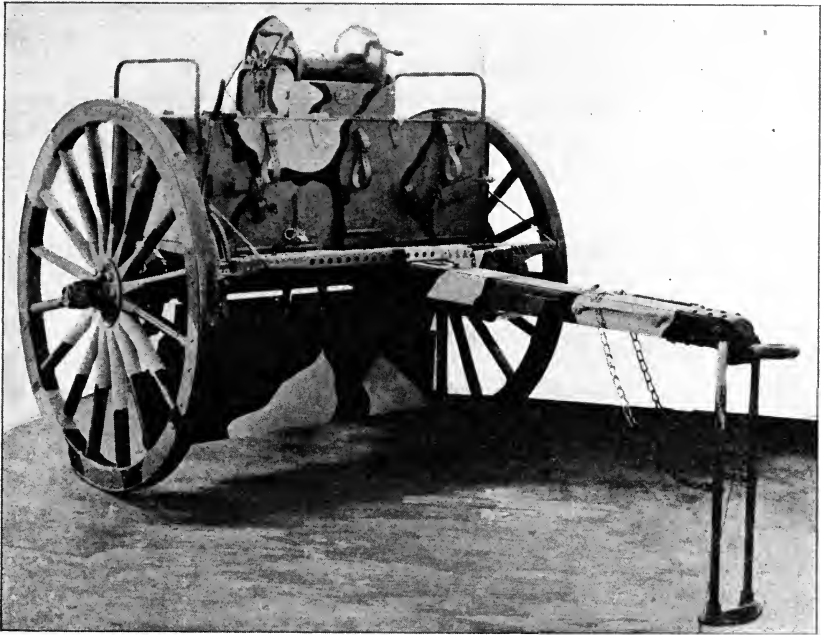

REEL FOR CAISSON, MODEL OF 1917, MOUNTED ON A CAISSON.

The reel for caisson, model of 1917, is a hand-operated reel for the transportation and handling of telephone wires.

The frame is built up of two-flanged steel ends and two sides, riveted together with four angle-iron corner reinforces and riveted to the top of the chest. The reel is built up of two steel spool flanges mounted on a shaft, a spool riveted to the right flange and a basswood spool hub mounted between the spool flanges.

The spool may be operated from either side. The crank on the right side is mounted on the shaft, and when not in use it can be removed and placed in its provided receptacle. The crank on the left side is connected with the spool through an 18 to 40 gear reduction. The crank shaft is fitted with a driving gear which meshes with a pinion

on the shaft of the spool. Chains are provided on either end of the frame for locking the cranks when not in use.

The reel is also fitted with a brake for controlling the speed of rotation when allowing wire to run out. The brake lever is pivoted on the brake-lever pin, and operated by a thong attached to the lower

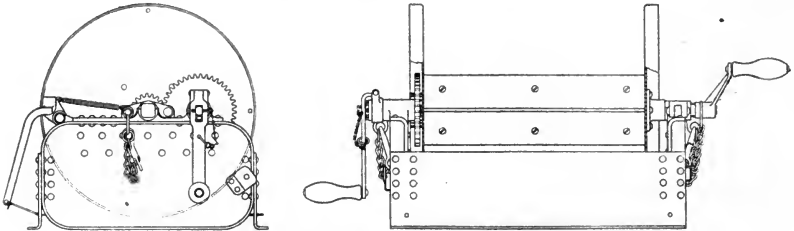

REEL FOR CAISSON, MODEL OF 1917.

end of the lever. By pulling the thong the upper end of the lever is made to drag on the inside of the rim of the left spool flange. A brake-release spring, attached to the upper end of the lever, and a lug on the left shaft bearing, keeps the brake open when not in use.

THE AUTOMATIC POLE SUPPORT.

Late designs of limbers for 75-millimeter and 3-inch gun matériel are fitted with an automatic pole support.

The pintle hook has a lug formed on its lower side, which projects backward and bears against the lower side of the lunette on the drawn vehicle, thus preventing the vertical rotation of the pintle.

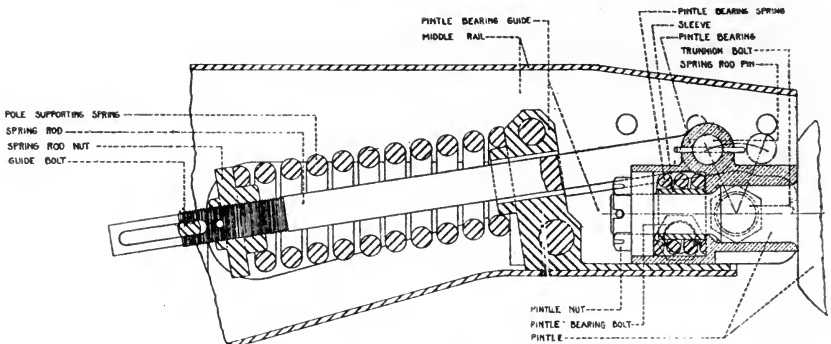

SECTIONAL DIAGRAM OF POLE SUPPORT.

The pintle bearing is pivoted by trunnion bolts permitting rotation in the vertical plane. A spring rod is pinned to a lug on the top of this bearing and carries the pole supporting spring. This spring is held between a collar on the rod and the pintle bearing guide so that when the weight of the pole on the coupled vehicle is put on the pintle it tends to compress the spring until the load is supported by it.

On the pintle bearing bolt is another spring, which is compressed when the pintle is drawn back, thus relieving the shock of starting.

4.7-INCH GUN MATÉRIEL, MODEL OF 1906.

The 4.7-inch, model of 1906, is a mobile field gun, designed to fire shrapnel or shell at greater ranges than the 75-millimeter guns. In order to increase the range, a 45-pound shell is provided to replace the old type 60-pound shell. The former projectile gives considerably higher muzzle velocity and longer range than the 60-pound projectile. The life of the gun before relining is approximately 5,000 rounds.

Using the 60-pound shrapnel, a muzzle velocity of 1,700 foot-seconds is obtained, with a maximum range of 7,550 yards (6,903 meters) at an elevation of 15° . With the 45-pound shell, with a muzzle velocity of 2,050 foot-seconds, a maximum range of 8,700 yards (7,900 meters) at an elevation of 15° , under normal conditions.

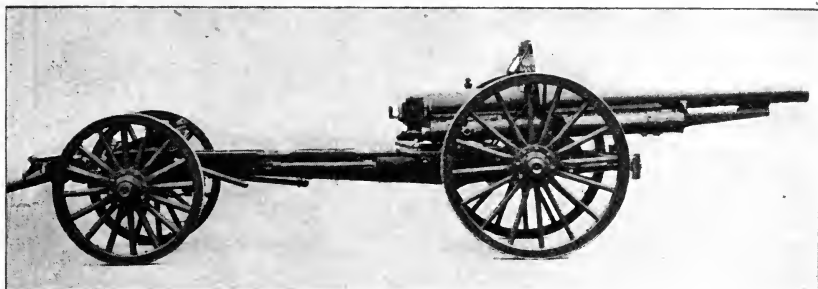

VIEW SHOWING CARRIAGE AND LIMBER IN TRAVELING POSITION.

The 4.7 inch field gun is mounted on a carriage of the long-recoil type, in which the gun is permitted a sufficient length of recoil on the carriage to render the latter practically stationary under firing stresses. The gun, in recoil, is controlled by two spring cylinders, and a hydraulic cylinder, which is filled with $25\frac{1}{2}$ pints of oil. In recoil, the oil in the hydraulic cylinder is forced from one side of the piston to the other through small portholes. The area of these ports are calculated to make the resistance which the liquid offers, plus the resistance of the springs, such that the wheels will not jump from the ground when the gun recoils. In counterrecoil the oil is forced back through these small ports with the result that the return of the gun into battery is so eased and regulated that shock and consequent derangement of the aim is almost eliminated. To properly return the gun to battery at high angles of elevation, the springs are assembled with an initial compression of approximately 1,500 pounds in each cylinder.

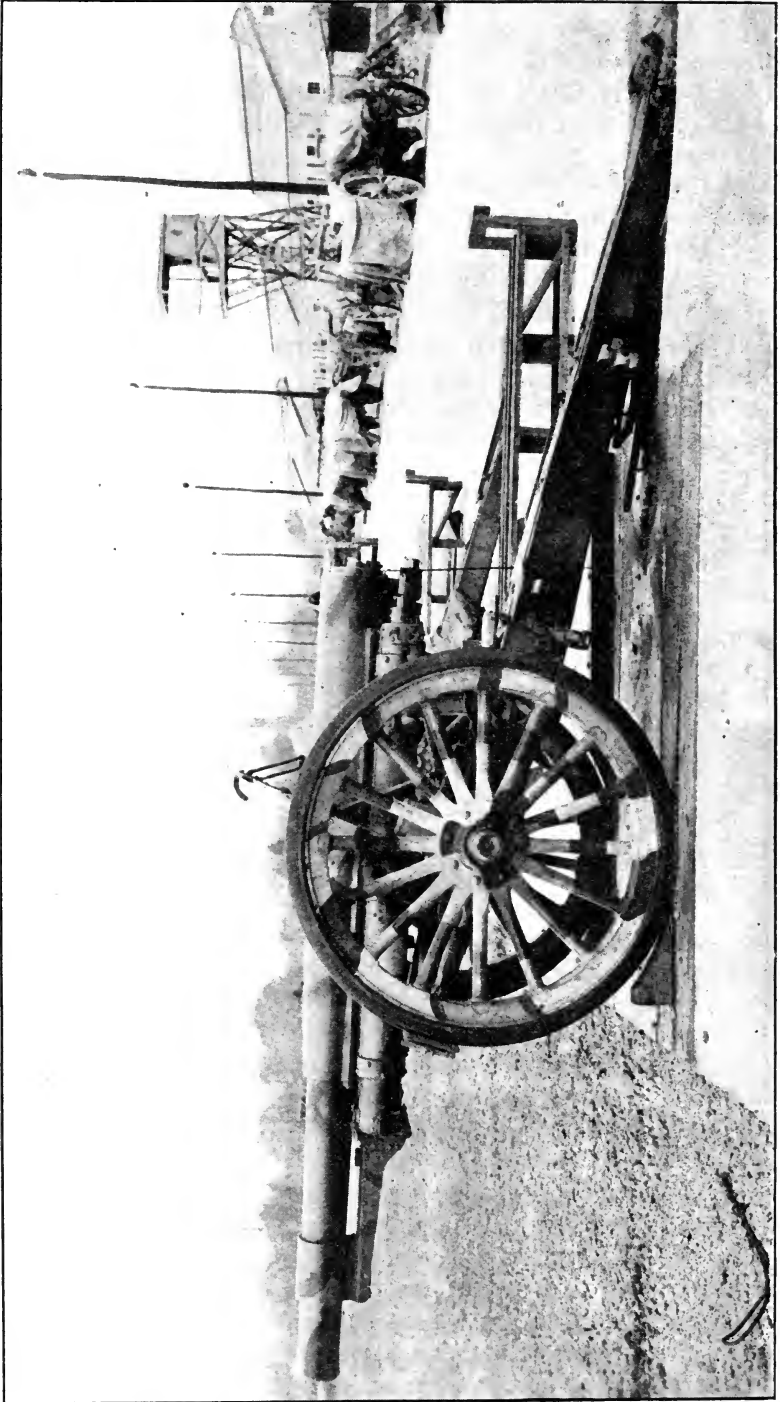

LEFT SIDE VIEW OF 4.7-INCH GUN CARRIAGE IN BATTERY.

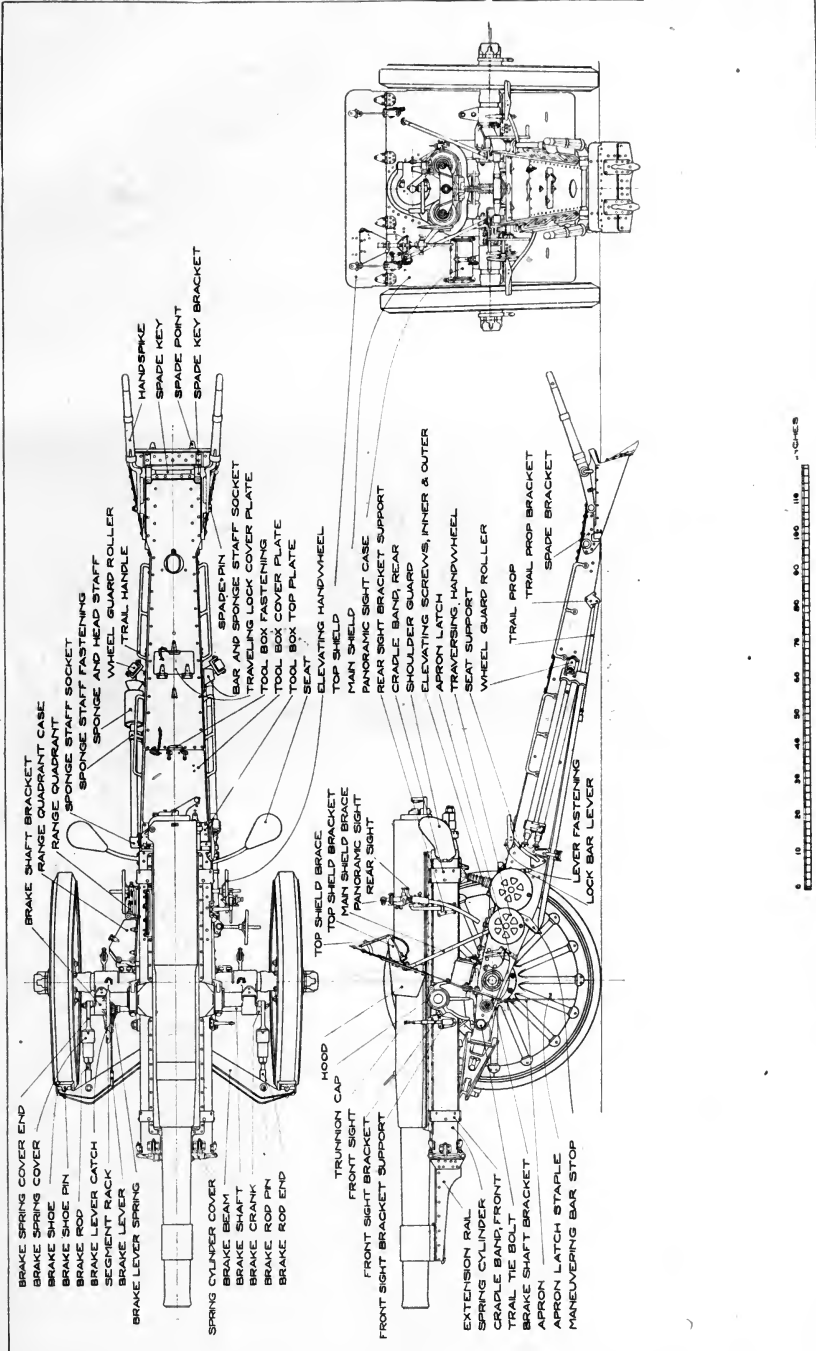

ASSEMBLED VIEWS OF 4.7-INCH CARRIAGE EQUIPPED WITH BAND BRAKES.

The carriage is equipped with a single trail, composed of two pressed steel flasks, and is anchored in the ground by a spade when in action. When traveling, the trail is supported by the carriage limber which may be drawn by either a truck or tractor. On account of the single trail the maximum elevation of the gun, without digging in the trail, is only 15°. The allowable transverse movement is 140 mils, or about 8°.

The motorized equipment of each gun carriage, as indicated below, consists of a carriage limber, which supports the trail when traveling, and three caissons, which carry ammunition.

4.7-inch gun and carriage, model of 1906.

4.7-inch gun carriage limber, model of 1905.

4.7-inch gun caisson, model of 1916 or 1917.

The above matériel is entirely of American design and manufacture.



LEFT FRONT VIEW OF CARRIAGE EQUIPPED WITH BAND BRAKES.

Weights, dimensions, and ballistics.

Weight of gun.....	pounds..	2,688
Total length.....	inches..	134.927
Rifling—Right hand, 1 turn in 50 calibers at origin to 1 turn in 25 calibers at 14.9 inches from muzzle, thence uniform.		
Weight of projectile, base fuze shell and shrapnel.....	pounds..	60
Weight of point fuze shell.....	do....	45
Weight of powder charge.....	ounces..	95
Weight of cartridge case.....	pounds..	8
Muzzle velocity (60 pound shell and shrapnel).....	ft. per sec..	1,700
Muzzle velocity (45 pound shell).....	do....	2,050
Maximum range at 15° elevation, of 45-pound shell.....	yards..	8,700
Maximum range at 15° elevation, of 60-pound shrapnel.....	do....	7,550
Weight of carriage, complete (without gun).....	pounds..	5,320
Weight of gun and carriage, fully equipped.....	do....	8,069
Diameter of wheels.....	inches..	61
Width of wheels.....	do....	6
Height of axis of gun.....	do....	51.59
Maximum angle of elevation (gun or carriage).....	degrees..	15
Maximum angle of depression (gun or carriage).....	do....	5
Amount of traverse.....	mils..	140(7.8°)
Height of line of sight.....	inches..	53.92

4.7-INCH GUN AND CARRIAGE, MODEL OF 1906.

The gun is of the built-up type, and consists of a tube, jacket, locking hoop, and clip. The jacket covers the rear half of the tube, and projects beyond the tube at the rear to form the breech recess. The

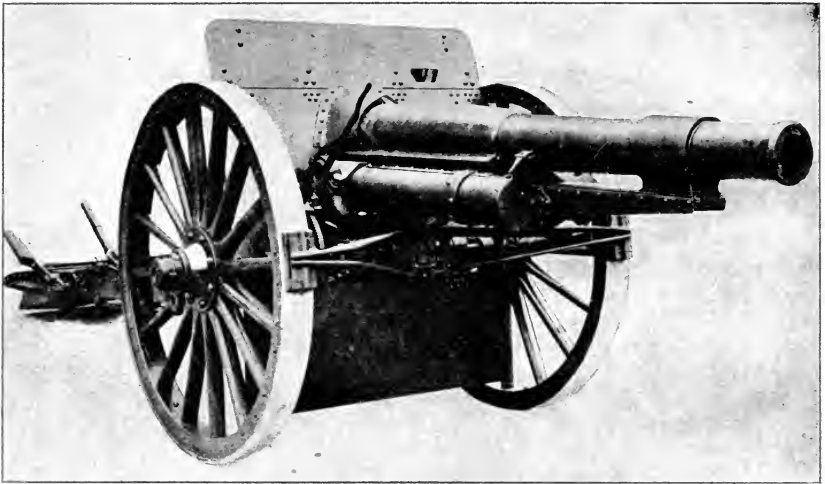

FRONT VIEW OF CARRIAGE EQUIPPED WITH TIRE BRAKES.

jacket is equipped with a recoil lug on the underside for connecting the recoil cylinder. The clip is a short hoop near the muzzle and is fitted with guides to guide the gun in the cradle on recoil.

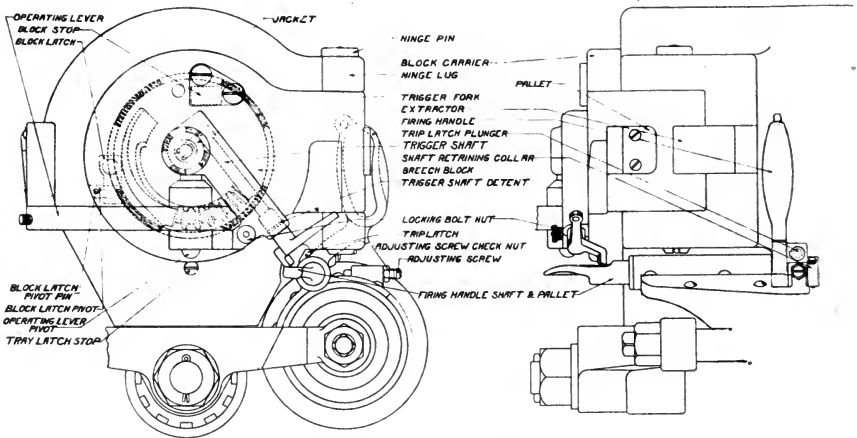

BREECH MECHANISM.

The breechblock is of the interrupted screw type having four threaded and four plain sectors. It is operated by a handle which swings from left to right, turning and withdrawing the breech with one motion. An extractor is fitted for throwing out the shell case when the breech is opened after firing.

The firing mechanism is of the type known as a continuous-pull mechanism; that is, the mechanism is cocked and fired by the pull on the lanyard or by downward pressure on the firing handle located at the left side of the breech.

The carriage is composed of the following principal parts: Wheels, axle, the cradle (for housing and supporting the recoil mechanism of the gun), trail, traversing and elevating mechanisms.

The gun carriage is of the long-recoil type, in which the gun is permitted to recoil on the carriage to render the latter stationary under firing stresses. The recoil mechanism consists of an hydraulic cylinder filled with oil, placed parallel to the gun, and attached to the cradle. The recoil cylinder controls the backward movement of the gun upon discharge, and the springs function to return the piece to battery position.

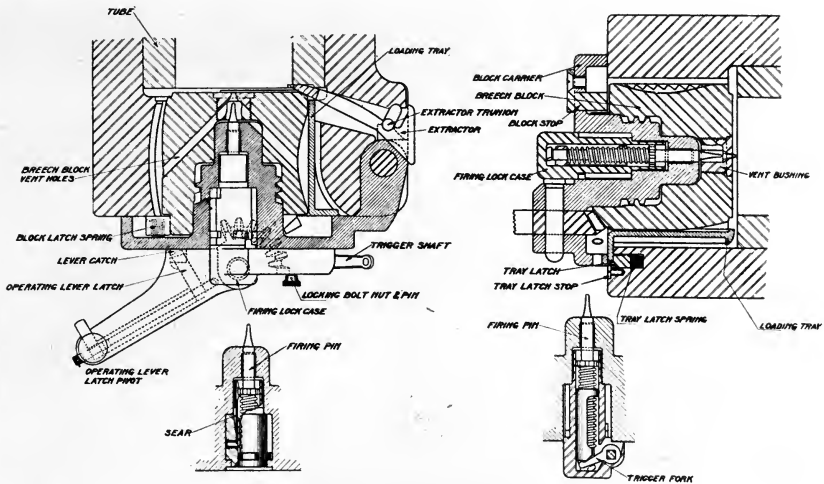

FIRING MECHANISM.

The recoil and counterrecoil mechanism is of the hydro-spring type, and consists of two parallel steel tubes (the spring cylinders) fitted into a frame and surrounded by rails which form the gun slides and the cradle. The recoil cylinder is fitted between these two.

The piston and spring rods secured to the gun lug and recoil with the gun, while the spring cylinders and recoil cylinder remain stationary.

The recoil is of the constant type, being 70 inches when the gun is fired at zero elevation, and is somewhat greater at higher angles, due to the action of gravity on the recoiling parts. The recoil cylinder uses hydroline oil as the buffer medium. Throttling is obtained by three throttling bars running lengthwise of the cylinder, which are of varying height to give a throttling effect with corresponding slots in the recoil piston. A counterrecoil buffer is fitted in the piston rod to take up the shock when the springs return the gun to battery.

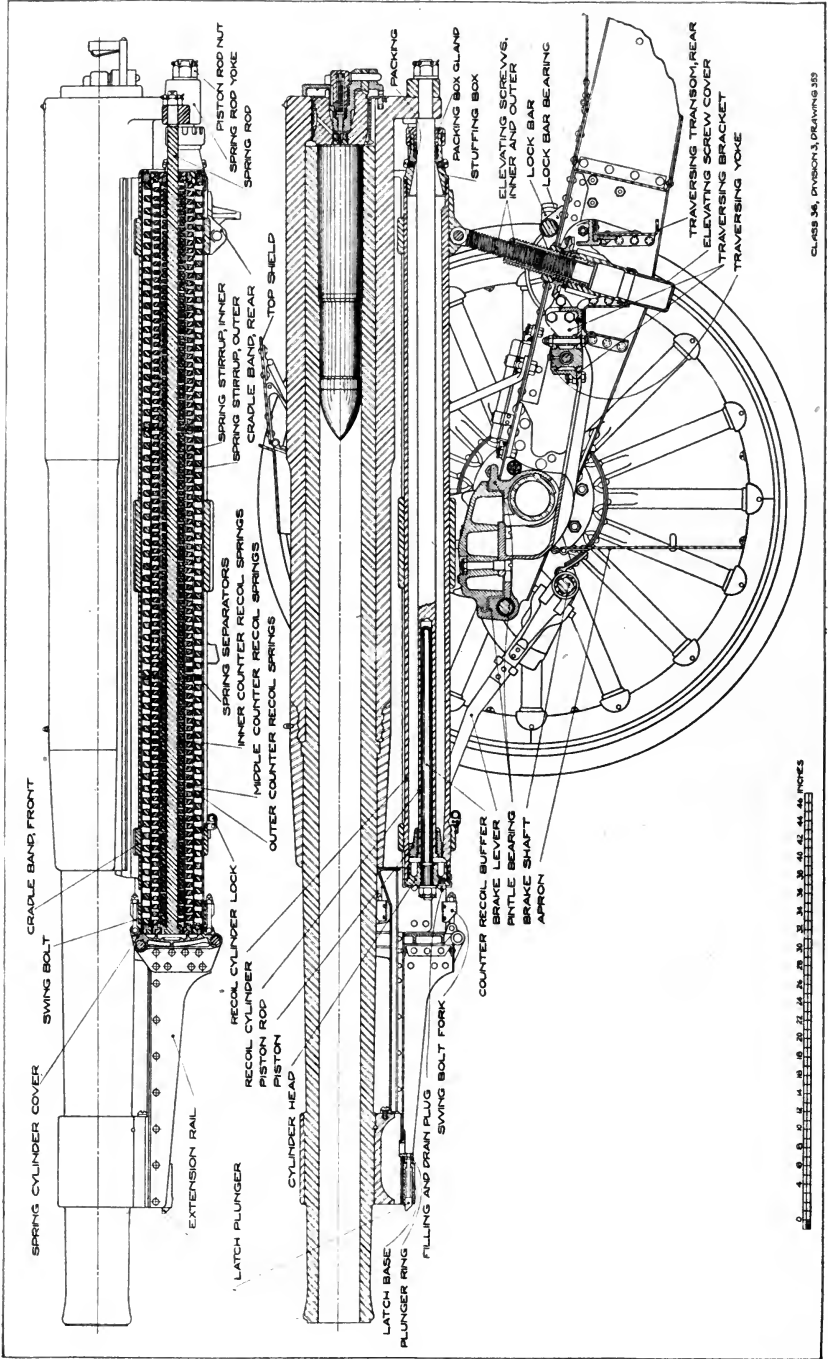

CLASS 34, DIVISION 3, DRAWING 335

LONGITUDINAL SECTION OF 4.7-INCH GUN AND CARRIAGE, MODEL OF 1916.

The trunnions on the cradle are mounted in bearings formed by a yoke which swivels in a pintle bearing provided at the front of the trail.

Traverse is obtained by means of a handwheel and screw mounted on the left side of the trail, which swings the yoke, it carrying the gun with it. A traverse of 70 mils on each side of center is possible.

The piece is elevated by a double screw type of mechanism. The upper end is attached to the cradle and so raises and lowers it.

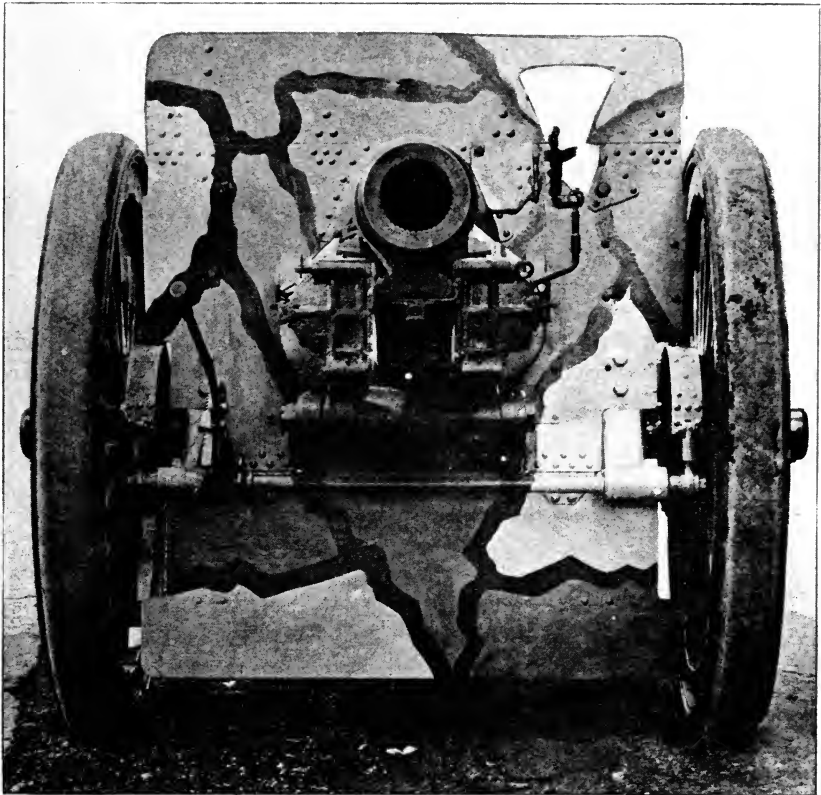

FRONT VIEW OF CARRIAGE EQUIPPED WITH BAND BRAKES.

The screw is operated through gearing by two handwheels, one on each side of the trail. From 5 degrees depression to 15 degrees elevation is obtained.

The trail is of the solid type, made up of flasks of channel section. It houses the axle and carries the pintle bearing in which the top carriage, or yoke, swings. A tool box is fitted in the trail, and a seat is provided on each side of the trail for the cannoneers. The lunette transom is fitted about 27 inches from the rear of the trail, and carries a bearing that fits the limber pintle. A trail prop is

provided for supporting the trail when limbering. The spade can be released and folded up on the trail when traveling.

A *traveling lock* is provided on the trail for locking the gun when traveling. The piston rod and spring rods must be disconnected before the gun can be drawn back far enough to lock.

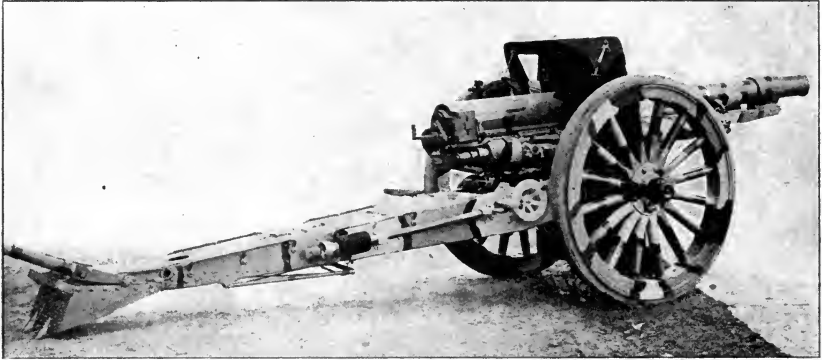

REAR RIGHT SIDE VIEW OF CARRIAGE.

The wheels are 61 by 6-inch rubber tires, and are equipped with band brakes. Some of the older type of vehicles have steel tires

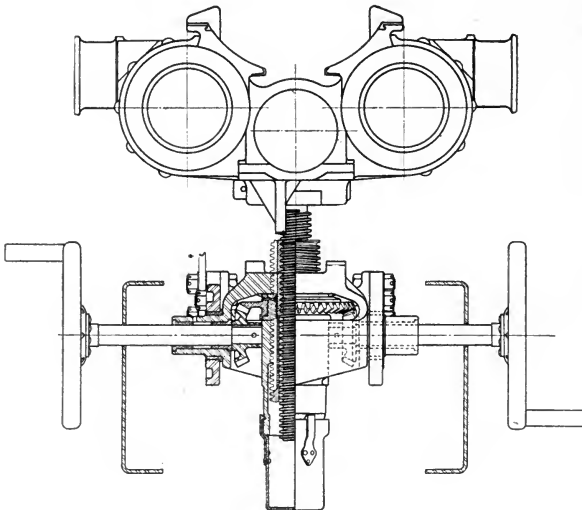

ELEVATING AND TRAVERSING MECHANISMS.

and are fitted with tire brakes. An armor plate shield is fitted to the carriage for the protection of the personnel.

The *sighting* is similar to the 3-inch gun, model of 1902.

The instruments for sighting and laying the piece include line sights, a rear sight, a front sight, a panoramic sight, and a range quadrant.

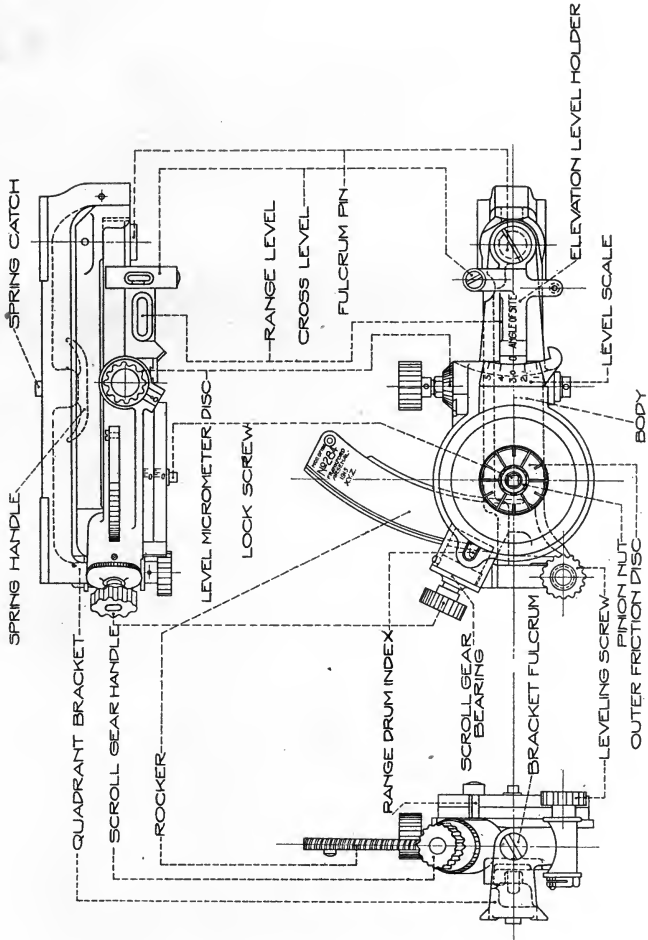

RANGE QUADRANT

The line sight consists of a conical point as a front sight and a V-notch as a rear sight. These are located on the jacket of the gun, and are useful for giving general direction to the gun.

The rear and front sights are used for direct aiming. The rear sight is a peep sight mounted on range scale shanks on left side

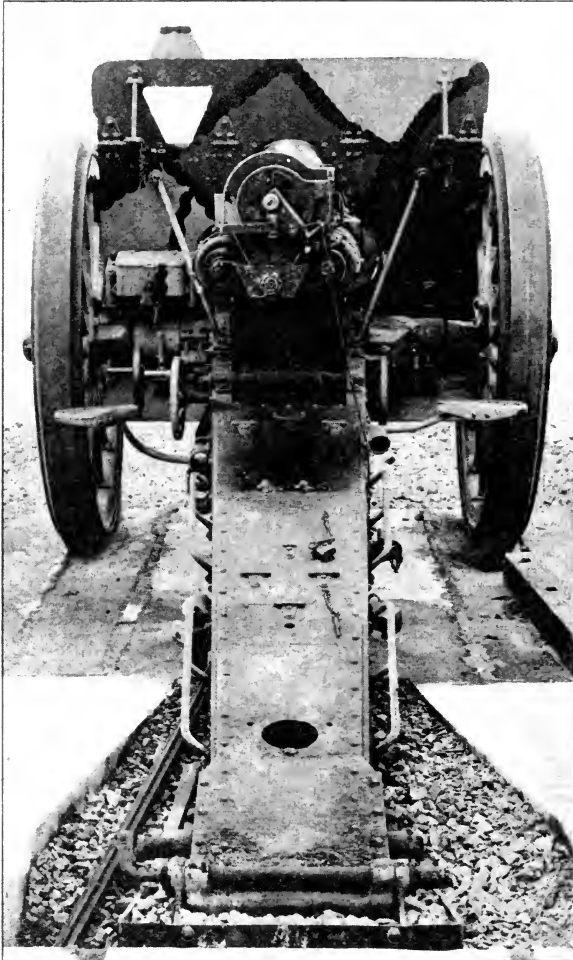

REAR VIEW OF CARRIAGE EQUIPPED WITH BAND BRAKES.

of the cradle. The front sight consists of a pair of cross wires mounted in a ring about three feet ahead of the rear sight.

The sight shank has a socket in which the standard United States panoramic sight may be mounted.

On the right side of the cradle is mounted the range quadrant, which has in combination with it the angle of sight mechanism. For indirect fire the gunner on the right of the piece lays for range with this instrument, and the one on the left lays for direction only.

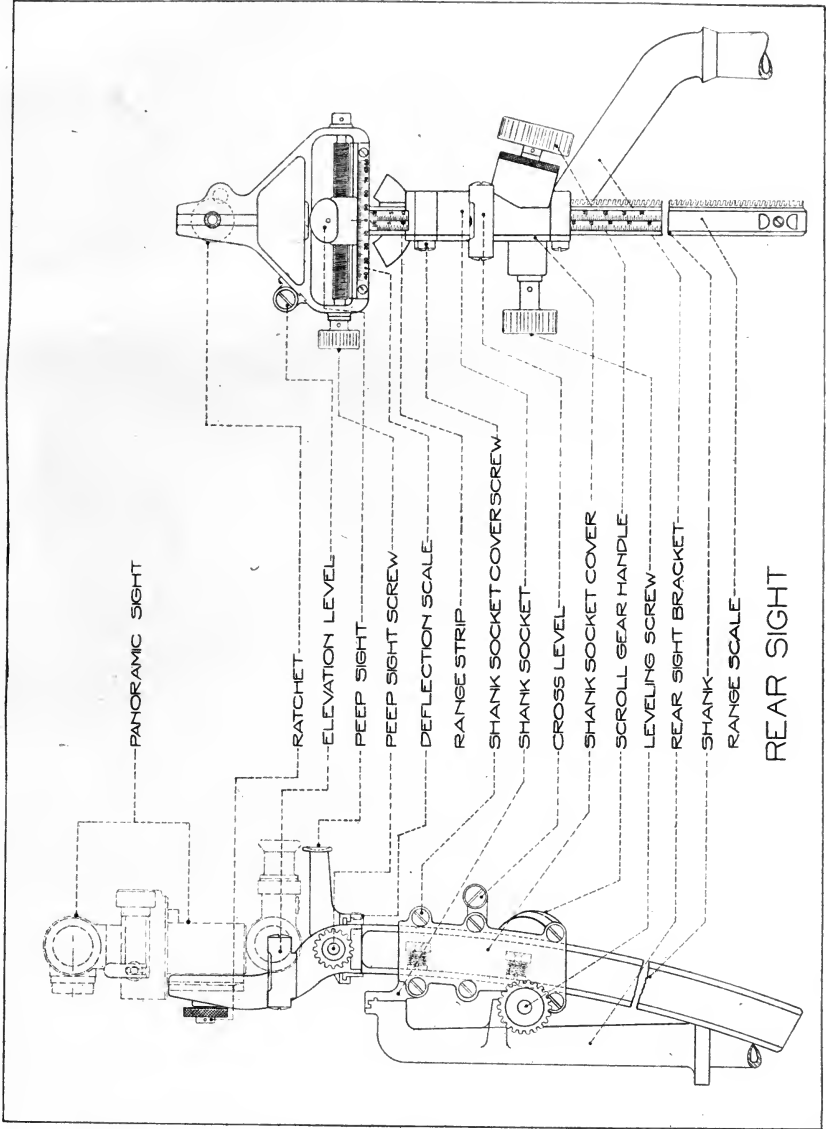

Fixed ammunition is used with this gun; shrapnel and high explosive shell being used. The base fuzed steel shell and the shrapnel

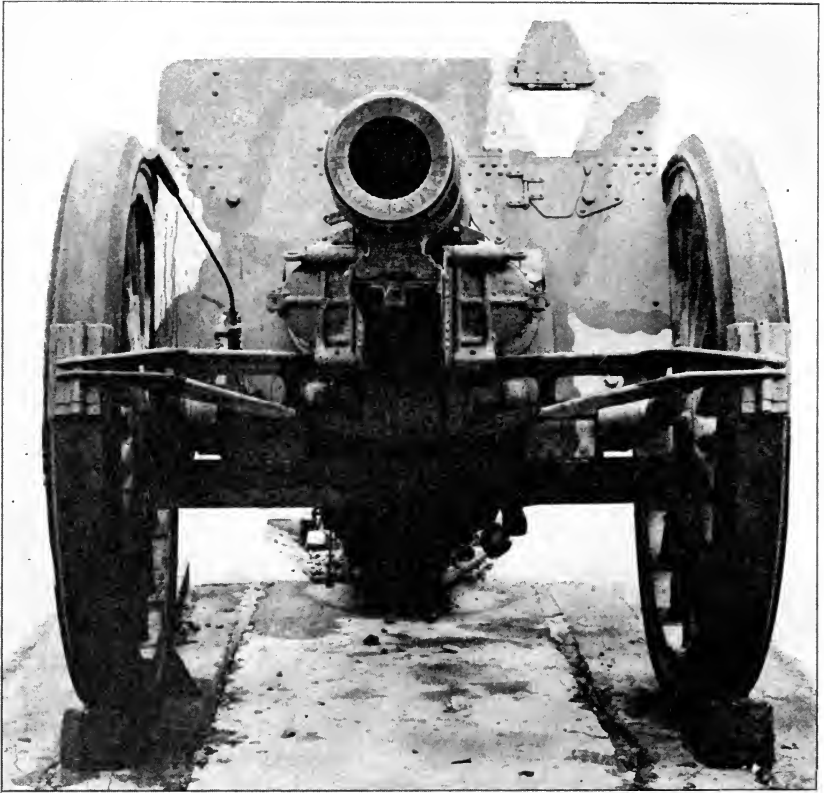

FRONT VIEW OF CARRIAGE EQUIPPED WITH TIRE BRAKES.

weigh 60 pounds. The point fuzed shell weighs 45 pounds. Gas shells are also issued and are identical with the 45-pound steel shell.

4.7-INCH GUN CARRIAGE LIMBER, MODEL OF 1905.

The limber, a two-wheeled vehicle to which the trail of the carriage is fastened, forming, with the gun carriage, a four-wheeled carriage for the gun when traveling.

The carriage limber is designed to be used with the connecting pole for attachment to a tractor and to support the trail in traveling. The limber is made of metal throughout, wood being used only in the spokes and felloes of the wheels. The principal parts are the wheels, axle, frame, top carriage, pole socket, and connecting pole.

The top carriage is a steel casting, formed to accommodate the trail of the 4.7-inch gun carriage, the trail resting on it when en route.

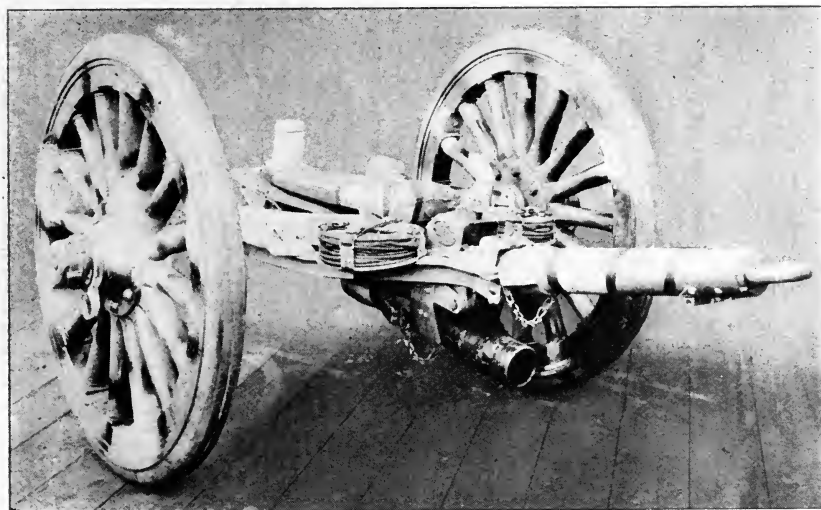

FRONT VIEW OF LIMBER.

The front end of the top carriage is provided with three rollers which rest and run on the top carriage rail; the rail edge being equipped with clips to prevent accidental dismounting. A spur located on the top carriage which enters the trail, holds the trail and top carriage in line.

The wheels are 51 inches in diameter, 4 inches wide, and are rubber tired. The hubs are similar and interchangeable with those on the wheels of the carriage. The axle is hollow and is made from a single piece of forged steel.

A bucket holder with straps is located on each side brace for carrying four canvas watering buckets.

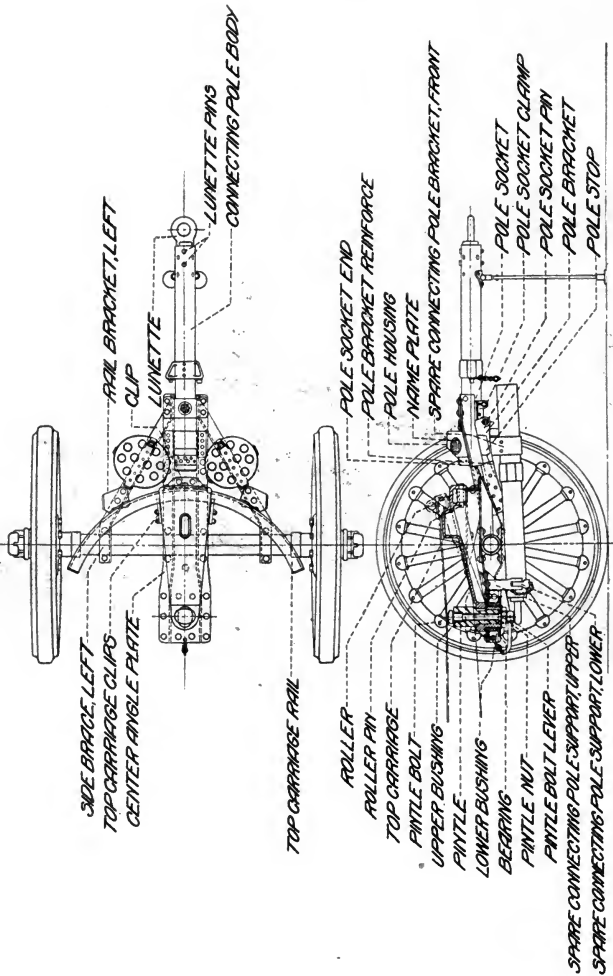

The doubletree, singletrees, and pole complete are omitted for motorized batteries and a connecting pole is used in their place. The standard short pole with lunette is fitted for motor traction and for horse-drawn equipment the longer pole may be substituted.

Weights and dimensions.

Weight, complete, including spare connecting pole.....	pounds..	1,750
Weight of limber with gun and carriage, traveling position.....	do....	9,818
Diameter of wheels (rubber tired).....	inches..	51
Width of track	do....	60
Free height under limber and carriage	do....	16.8

4.7-INCH GUN CAISSON, MODEL OF 1908.

The 4.7-inch gun caisson is constructed upon the same general plan as the 4.7-inch caisson limber. The wheels, axles, pintles and bearings, lock bars, and most of the implement fastenings and chest parts of the two vehicles are exactly similar and interchangeable.

The principle parts of the caisson are the wheels, axle, axle bearings, ammunition chest, pintle, connecting-pole socket, connecting pole, prop, apron, and brake.

The flange-steel front plate and chest door (upper) of the limber are on the caisson replaced by armor plates, for the protection of

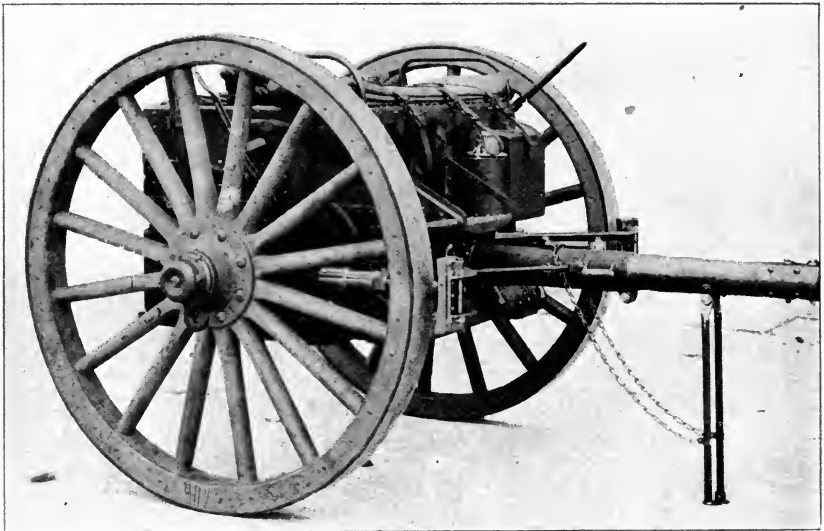

RIGHT SIDE VIEW OF CAISSON.

ammunition servers from small arms and shrapnel fire. An apron of armor plate is hinged to the bottom of the caisson chest and extends to within a short distance of the ground for the same purpose. This apron swings forward against the bottom of the ammunition chest to clear obstructions in traveling, and is held in that position by latches attached to the sides of the chest.

The pole socket of the caisson is made longer than on the caisson limber, and is fitted with rollers which serve as wheel guards. The connecting body is made of steel tubing, its rear end is finished to fit the pole socket, and is provided with a seat for the rectangular key which secures the connecting pole to the socket. A prop of

steel tubing with a bronze foot is attached to the connecting pole for a support when the caisson is unlimbered; when not in use the prop is swung up under the connecting pole and is held by chains.

The beams of the road brake are hinged in brackets riveted to the chest front. The brakes are built up of flange and forged steel parts and carry cast iron shoes to bear against the wheel tires.

Hangers for a spare connecting pole and a bracket for a spare key are provided on the chest. The ax, hatchet, lantern, and watering bucket fastenings are similar, and located like those on the caisson limber. The paulin on the caisson chest serves as a seat cushion and on either side of the chest handrails provide handholds for the cannoneers, when mounting or dismounting.

The opening between the upper and lower intermediate plates on the left side is utilized to carry a two-gallon oil can. Of every four caissons, three carry oil cans containing lubricating oil, and the fourth, hydrolinè oil, the contents of each being indicated by a name plate.

Weights, dimension, etc.

Weight of caisson limber, empty (without implements or ammunition). pounds..	1, 821
Weight of implements carried.....do.....	85
Weight of ammunition carried.....do.....	2, 055
Weight of limber, fully equipped and loaded.....do.....	3, 961
Weight of caisson, empty (without implements or ammunition).....do.....	2, 058
Weight of implements carried (including spare connecting pole).....do.....	147
Weight of caisson fully equipped and loaded.....do.....	4, 260
Rounds of ammunition carried in caisson limber.....	28
Rounds of ammunition carried in caisson.....	28
Diameter of wheels.....inches..	60. 0
Width of track.....do.....	60. 0
Free height under caisson.....do.....	19. 55
Turning angle.....degrees..	80

4.7-INCH GUN LIMBER, MODEL OF 1908.

The limber is a two-wheeled vehicle provided with an ammunition chest for the transportation of ammunition for the 4.7 inch gun.

The principal parts are the wheels, axle, ammunition chest, pintle, pole socket, pole, doubletree, singletrees, and neck yoke.

The wheels and the wheel fastenings are the same as, and are interchangeable with, those on the carriage. The axle is hollow and of a single piece of forged steel. It is secured to the chest by axle bearings riveted to the sides of the chest and to the flanges of the intermediate plates.

The ammunition chest is built up of flange steel and is divided into an upper and lower compartment by intermediate plates. Cor-

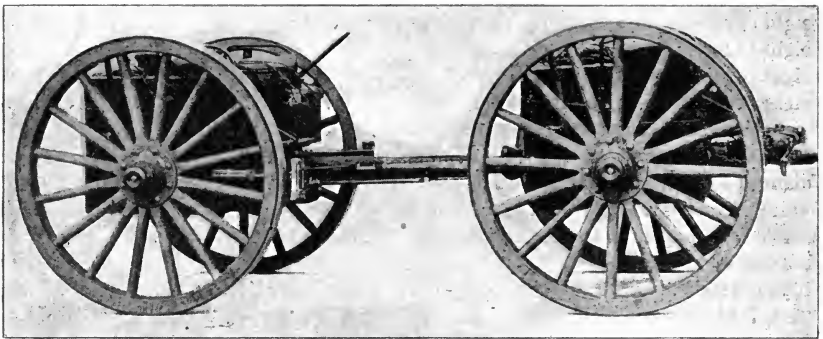

VIEW SHOWING GUN CAISSON AND LIMBER, LIMBERED.

responding holes in the middle and rear diaphragms are connected by conical brass tubes called connecting pieces, which are cut away on top to save weight. These connecting pieces support the front end of the cartridge case and serve to guide the projectiles. The chest doors close against the heads of the cases so that the cartridges are firmly held in position. Suitable clearances are cut in the flange of each cartridge pocket to enable the cartridge hook to get back of the rim of the case in withdrawing it from the chest.

The doubletree is mounted upon a doubletree pin projecting up through a boss on the forward end of the pole socket. A limber prop is hinged to the pole socket. When traveling, the prop is drawn up to the rear and held by a chain.

The pintle swivels 360° in the bearing, but is normally held in a vertical position by a spring bolted to the pintle bearing support.

The right side of this vehicle is equipped with fixtures for holding a pick, hatchet, and pickax; while on the left side provision is made for a shovel.

The paulin on the top of the chest is held in place by straps suitably fastened. Other fastenings on top of the chest are for a picket rope, an ax, and a limber blanket. On the front are attachments for a wrench and a pole prop. The cartridge hook for use in withdrawing the cases and projectiles from the chest is fastened on the left side of the caisson. A spanner for tightening the hub bands of the wheels is carried between the intermediate plates.

The pole, doubletree and singletrees, and neck yoke are standard and interchangeable with those on any limber of the battery. Doubletree chains attached to the chest body prevent excessive movement of either end of the doubletree.

The 4.7-inch gun limber, model of 1908, is only used in connection with the 4.7-inch gun caisson, model of 1908, both being of American design and manufacture. These vehicles are used with motorized as well as horse-drawn batteries of 4.7-inch gun matériel.

4.7-INCH GUN CAISSON, MODEL OF 1916.

The caisson, model of 1916, is a two-wheeled vehicle with an armored ammunition chest for the transportation of ammunition for the 4.7-inch gun. This vehicle is designed to carry 28 rounds of

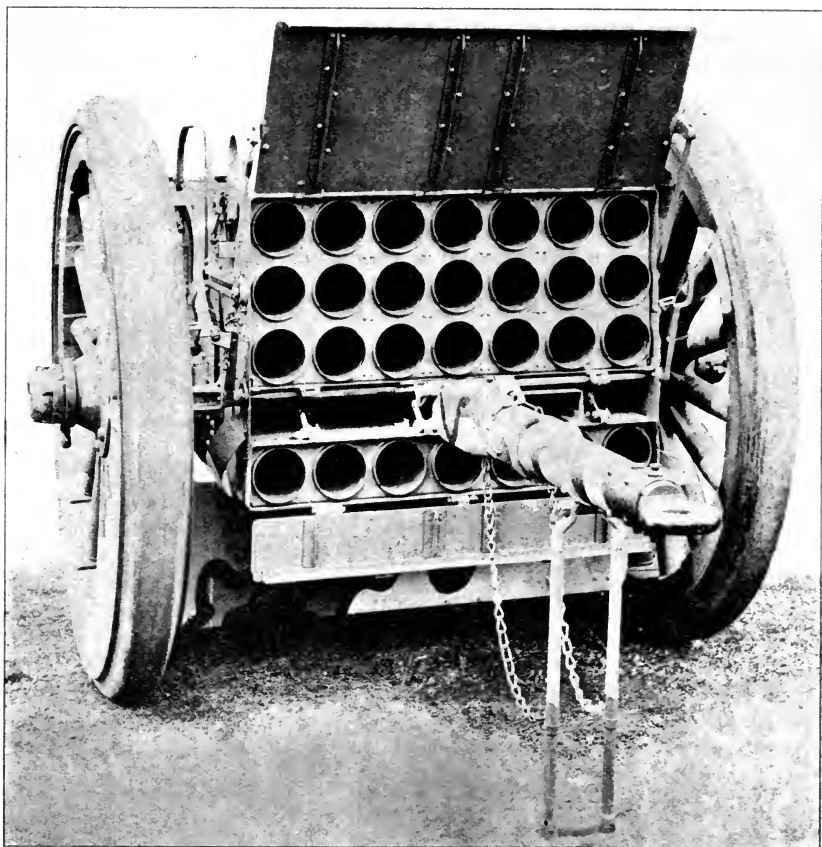

RIGHT FRONT VIEW SHOWING CHEST DOORS OPEN EXPOSING DIAPHRAGMS.

the fixed type of ammunition. The body is suspended in such a manner that 7 rounds are carried below and 21 above the axle.

The chest is built entirely of steel, but the upper door, rear plate, and an apron hung under the body are of armor plate for protection of the ammunition servers in the rear, from shrapnel and small-arms fire. The doors open to the front, and when closed bear on the heads of the shells. Suitable fastenings are provided on this chest for carrying the usual complement of tools and accessories, also brackets for

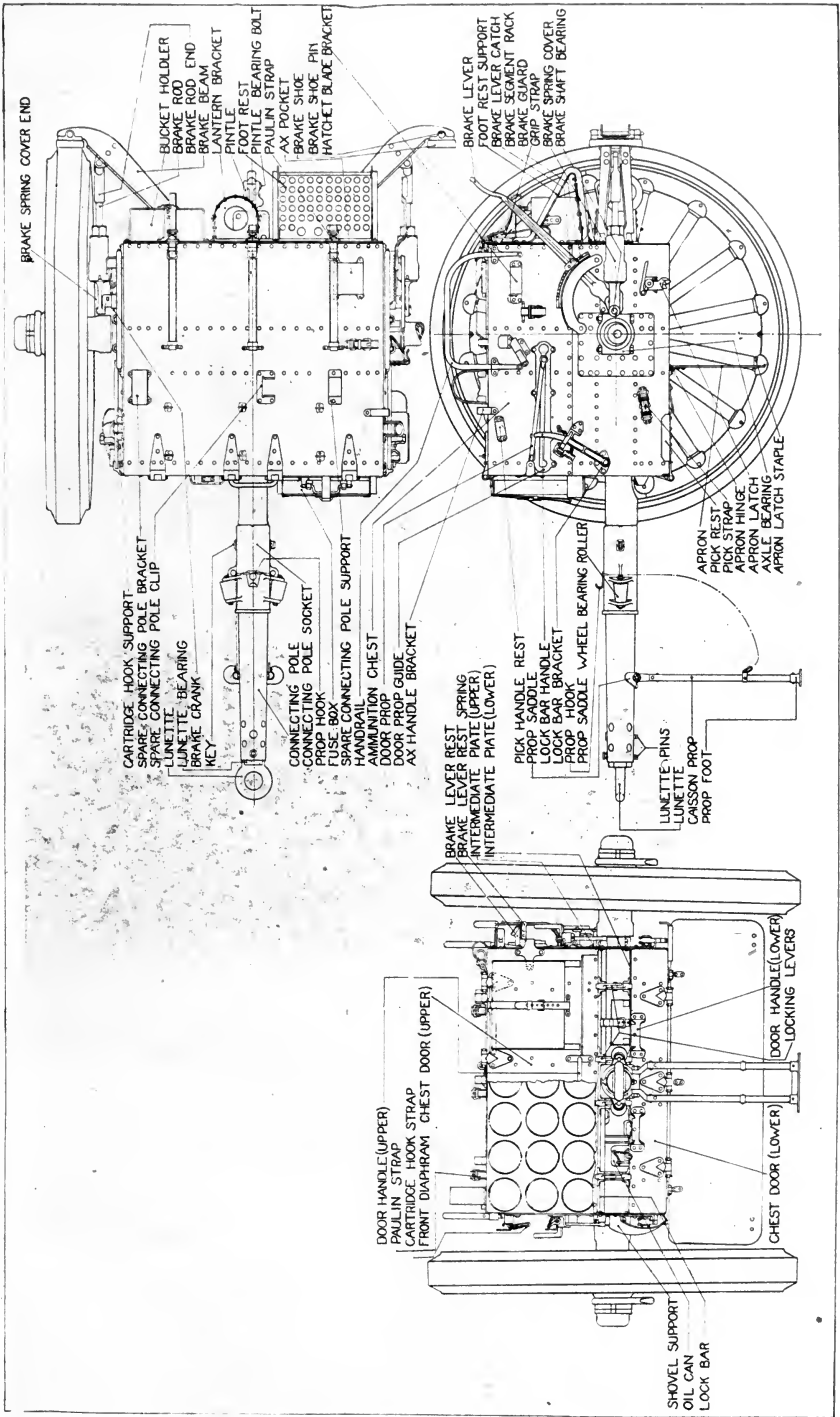

36-2-106

ASSEMBLED VIEWS OF 4.7-INCH GUN CAISSON, MODEL OF 1916.

carrying fuze boxes on the outside of the chest. The chest provides seats for two cannoneers.

This caisson is provided with an ammunition chest of sufficient size to carry either shrapnel or high-explosive steel shells. It is also equipped with fixtures for holding picks, shovels, and other tools on the outside of the ammunition chest. By removing the connecting pole, and adding double and singletrees, this vehicle may be transformed into a caisson limber suitable for horse traction.

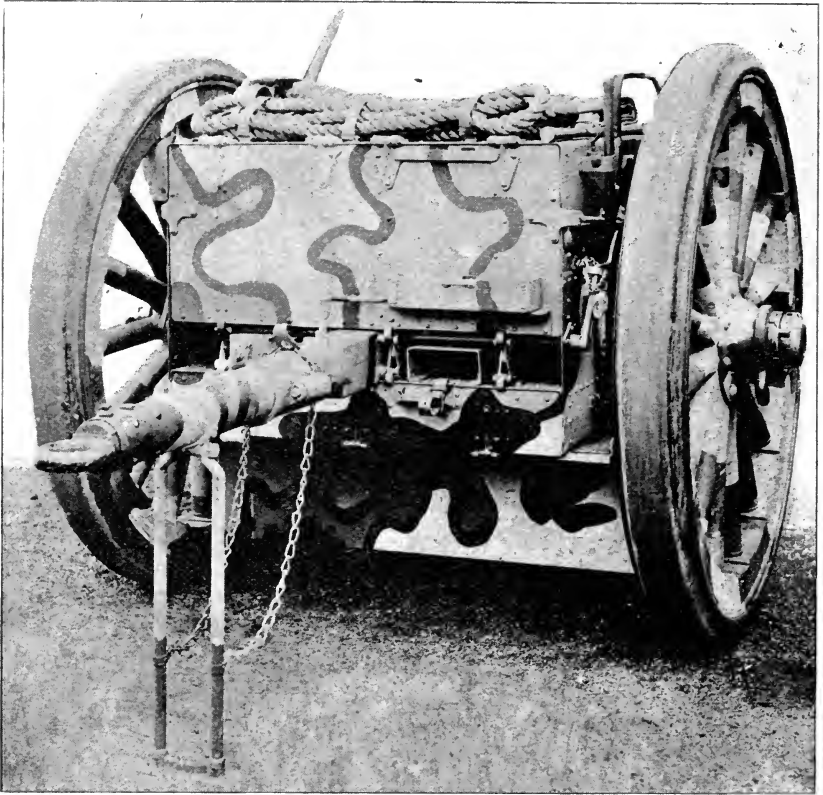

FRONT VIEW OF GUN CAISSON.

The principal parts of the vehicle are the wheels, axle, ammunition chest, pintle, brake, connecting pole socket, and connecting pole.

The wheels and wheel fastenings are the same as, and are interchangeable with those on the carriage. The axle is fastened to the chest by axle bearings riveted to the chest sides.

The body of the chest is of flange steel riveted together forming the top, bottom, and sides of the chest. The chest doors close against the heads of the cases so that the cartridges are held firmly in position. Suitable clearances are cut in the flange of each car-

tridge pocket to enable the cartridge hook to get back of the rim of the case in withdrawing it from the chest. The chest doors open to the front, the lower door being hinged to the bottom of the chest, the upper to the top of the chest, and by means of a lock bar, the doors are locked.

The armor-plate apron is hinged to the bottom of the caisson, so that when traveling it may be swung backward against the bottom, where it is held by latches on the chest sides.

The vehicle is equipped with a short connecting pole in front provided with a suitable prop for holding the pole up when the caisson is at rest. At the rear is the standard pintle enabling other vehicles to be connected en train.

On the tire brake models, brackets are riveted to the end of the chest. To these brackets are pinned the brake beams by the same kind of leverage system as on the carriage. The brake shoes are brought to bear on the tire by pressure on the brake lever, the brake lever and segment being on the left side of the vehicle.

The brake band model like the tire brake, has the brake lever on the left side of the chest and is of the contracting band brake type. Pulling up on the brake lever causes the brake bands to grip the drums bolted to the wheels.

The top of the chest has provision made for carrying a picket rope and spare connecting pole, an ax, and straps for a paulin that also serves as a seat cushion. The left side carries the pick, mattock and hatchet; the right, a long-handled shovel, cartridge hook and pole socket key. On the back are riveted a bucket holder, lantern bracket and a foot rest.

Between the intermediate plates in front, an oil can is carried on the right side, a fuze box on the left, and also a spanner wrench. In every battery, one caisson is provided with a hand reel containing one mile of wire as for the caisson model of 1917. See page 159.

Weight, dimensions, etc.

Weight of caisson, empty with implements or ammunition.....	pounds..	2,565
Weight of implements carried including spare constructing pole.....	do....	180
Weight of ammunition.....	do....	2,067
Weight of caisson fully equipped and loaded.....	do....	4,812
Round of ammunition carried.....		28
Diameter of wheels.....	inches..	61
Width of track.....	do....	60
Free height under caisson.....	do....	20.8

4.7-INCH GUN CAISSON, MODEL OF 1917.

The caisson, model of 1917, is a two-wheeled vehicle equipped with an armored ammunition chest for the transportation of ammunition for the 4.7-inch gun. The two most important changes from previous models are: The substitution of a band brake for a tire brake, and a spring support for the ammunition chest.

The principal parts of the caisson are: The wheels, axles, spring support, ammunition chest, brakes, pintle, and connecting pole.

The wheels are 60-inch, steel tired with standard hubs and fasteners. The axle is a hollow single piece of forged steel. A distinguishing feature of this caisson is the spring-supported chest. Suitable brackets are provided on the chest and arms on the axle for carrying spiral springs to take up road shocks.

The ammunition chest is built up of flanged steel, except the rear plate, apron and chest doors, which are of armor plate. The body of the chest is made of two sheets of flanged steel formed to shape and joined at the sides. Three vertical diaphragms with connecting pieces provided an even distribution of the load of ammunition. The upper door when raised is held at about a 60° angle. The lower door is made with an armor plate apron hinged to its top edge, so that when it is dropped, it forms, with the upper door and rear plate, an armor-plate protection.

The road brake is of the contracting band brake type and is operated from the right side of the chest by pulling up on the brake lever; this through a linkage causes the brake bands to grip the drums of the wheels.

The connecting pole is attached to the caisson by a socket, the inside being tapered to accommodate the rear end of the connecting pole, also the horse pole.

Two foot rests of commercial flange steel are riveted to the upper chest door; these also serve as handles in opening and raising the door. A lantern bracket, and fastenings for holding a pick, shovel, lunette, and spanner wrench are riveted to the rear plate. At the top are riveted fastenings for holding an ax, connecting pole; also strap fastenings for the paulin and the caisson blankets. A cartridge hook and hatchet fastenings are riveted to the left side of the chest.

Of every four caissons three carry lubricating oil and one hydroline oil. One caisson in every battery is provided with a reel for caisson,

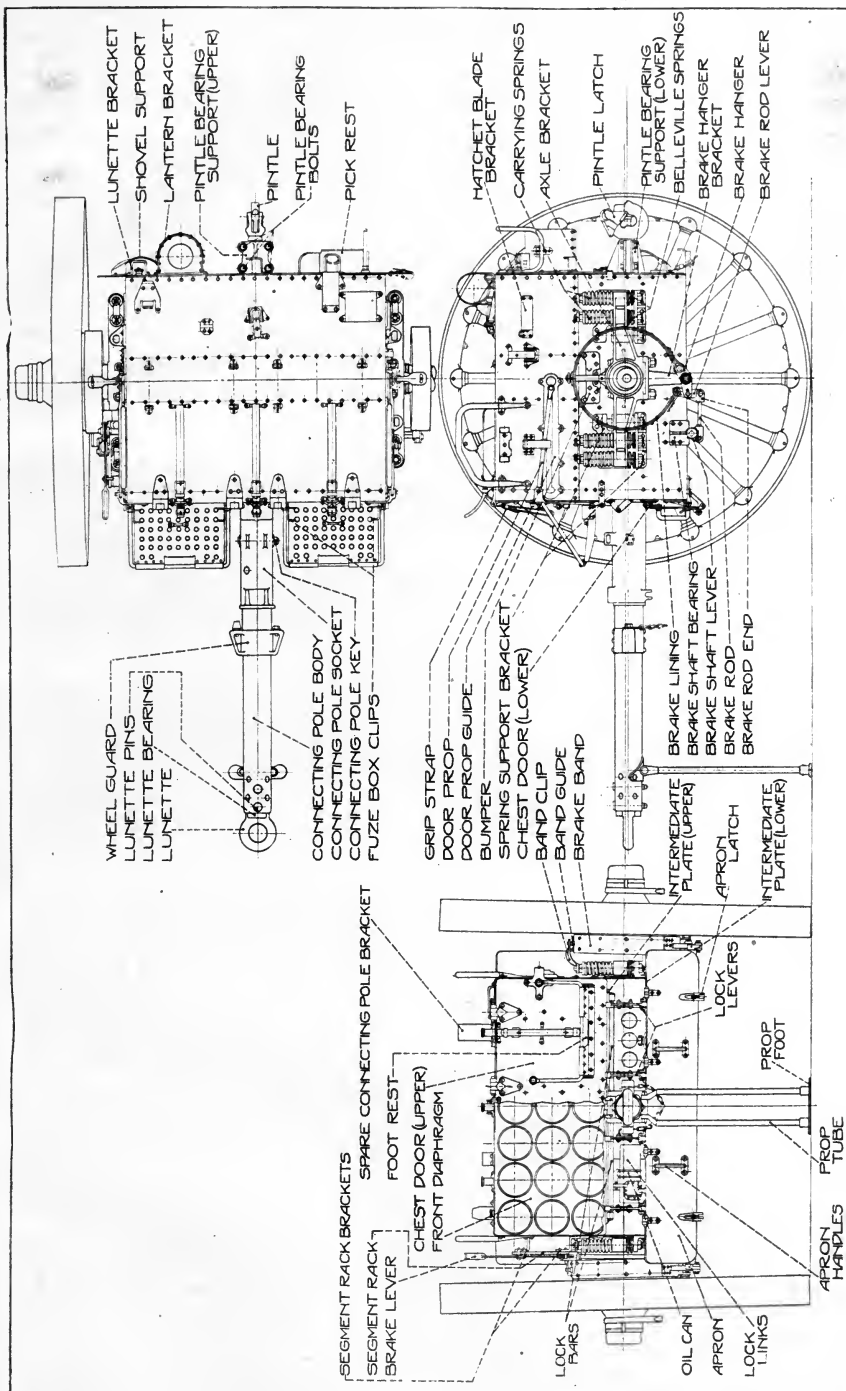

36-2-105

ASSEMBLED VIEWS OF 4.7-INCH GUN CAISSON, MODEL OF 1917.

model of 1917, which is riveted to the top of the caisson and contains 1 mile of field wire so arranged that the "talk" goes through all the wire. See page 159.

By changing the connecting pole and adding the doubletree and singletrees this caisson is converted into a caisson limber. A standard pintle with a semiautomatic latch is provided at the rear.

Weights and dimensions.

Weight of caisson, empty, without implements or ammunition	pounds..	2,053
Weight of implements carried, including spare pole.....do....		180
Weight of ammunition.....do....		2,067
Weight of caisson fully equipped and loaded.....do....		4,300
Rounds of ammunition carried.....		28
Diameter of wheels.....	inches..	60
Width of track.....do....		60

5-INCH, 60-POUNDER, GUN MATÉRIEL (BRITISH.)

The United States procured a number of batteries of 5-inch, 60 pounder guns with the necessary accompanying vehicles from Great Britain.

The matériel is of British design and manufacture throughout, and the units ceded to the United States include the gun, Mark I, mounted on a carriage, Mark II; the gun carriage limber, Mark II, the ammunition wagon, Mark II; and the ammunition wagon limber, Mark II.

The matériel was originally designed for horse transportation and thus is provided with poles and the necessary attachments for horse

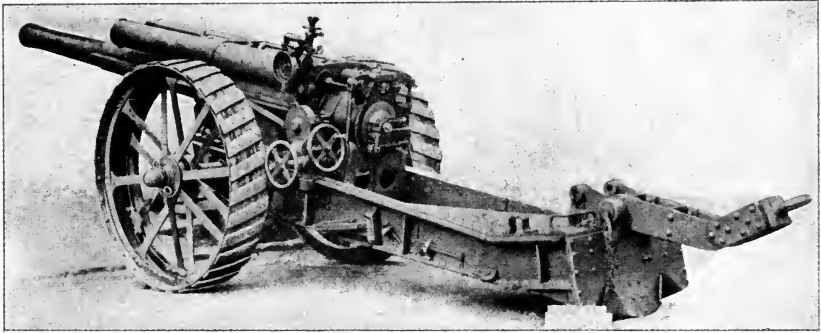

REAR LEFT VIEW OF CARRIAGE IN BATTERY.

draft. By substituting the engine-draft connector in place of the horse draft poles, the matériel is converted into motorized batteries and may be drawn by tractors. When horse drawn, it is customary to divide the four vehicles into two trains, each having two vehicles; however, when the battery is adapted for motor draft, the four vehicles are drawn as one train.

The load of the gun carriage and limber is about as heavy as is practicable for horse transportation, although the British originally designed their 8-inch howitzer matériel, which is of greater weight, for horse transportation.

The carriage is of the constant recoil type, the recoil mechanism being of the hydro-spring type, located above the gun. The recoil mechanism consists of two spring cylinders and one hydraulic cylinder filled with glycerine and water.

The piston rod of the recoil cylinder and the rods of the two spring cylinders are connected to the lug on the breech ring of the gun and therefore recoil with the gun.

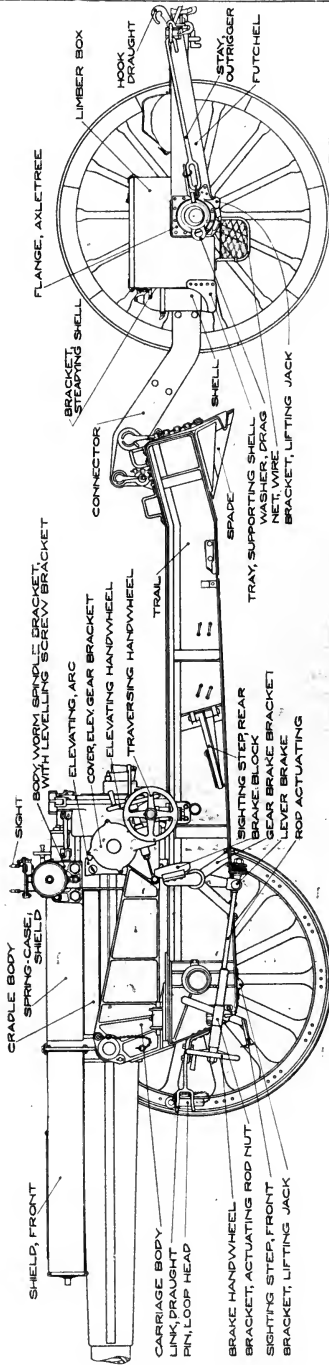

5 INCH 60 PDR. GUN (BRITISH), MARK II
 AND CARRIAGE LIMBER, MARK II
 TRAVELING POSITION, LEFT ELEVATION

Upon recoil of the gun, the liquid is forced past the piston head through a throttling groove or slot cut in the wall of the cylinder. The resistance offered by the action of the liquid in the cylinder, together with the resistance offered by the compression of the springs in the cylinders, controls and absorbs the shock of recoil, permitting the carriage to remain practically stationary upon the ground when the piece is fired.

The energy stored up in the spring cylinders due to the compression of the springs during recoil is sufficient to cause the gun to return to the firing position.

A hydraulic counterrecoil buffer is provided at the front of the hydraulic cylinder and acts as a cushion, thereby preventing the violent return of the gun to firing position.

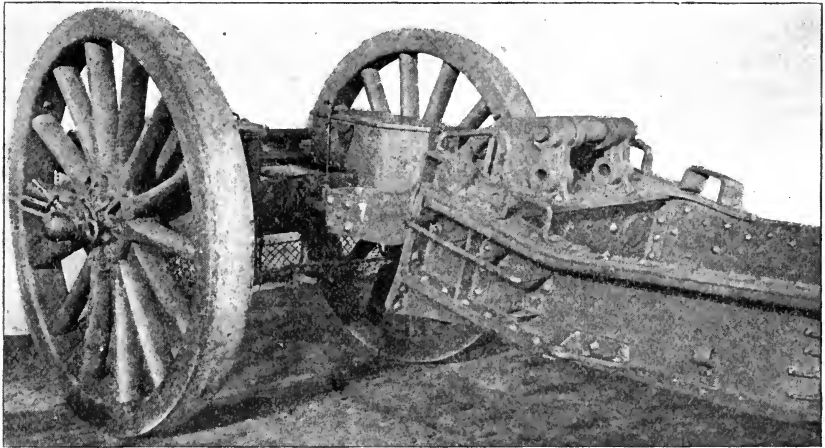

VIEW SHOWING TRAIL CONNECTED TO LIMBER.

A range of 12,280 yards (11,230 meters) is possible, when firing a 60-pound projectile with a muzzle velocity of 2,080 feet per second at the maximum elevation of $21\frac{1}{2}^{\circ}$.

The carriage is equipped with tractor wheels provided with independent wheel brakes.

The trail is of the single unit type, being broadened at the spade end and equipped with a fixed spade for anchoring the trail to the ground.

When traveling, the carriage is connected to the limber by an adjustable connector.

The carriage permits elevation from 5° depression to $21\frac{1}{2}^{\circ}$ elevation. The carriage permits traverse of 4° left and 4° right, when it is elevated at $16\frac{1}{2}^{\circ}$ or less. At higher elevations the traverse is but 3° right and 3° left, due to the interference of the trail with the gun at these elevations.

Weights, dimensions, and ballistics.

Weight of carriage and gun.....	pounds..	12, 096
Weight of gun and breech mechanism.....	do....	4, 858
Weight of carriage.....	do....	7, 238
Weight of projectile.....	do....	60
Weight of powder charge.....	do....	9. 44
Pressure of trail on ground.....	do....	920
Length of gun.....	inches..	168. 05
Length, over all, of carriage and limber, traveling position, with gun but without limber pole.....	feet..	28. 625
Length, over all, of carriage and limber, traveling position, with gun and pole.....	feet..	37. 5
Length between axles, of carriage and limber, traveling position.....	do....	13. 75
Height of axis of gun from ground.....	inches..	51. 5
Maximum elevation.....	degrees..	21. 5
Maximum depression.....	do....	5
Traverse (at elevation of $16\frac{1}{2}^{\circ}$ or less):		
Degrees right.....	4
Degrees left.....	4
Traverse (at elevation above $16\frac{1}{2}^{\circ}$):		
Degrees right.....	3
Degrees left.....	3
Range, maximum.....	yards..	12, 280
Muzzle velocity, normal.....	ft. per sec..	2, 080
Rifling, uniform 1 turn in 30 calibers.		
Diameter of carriage wheels.....	inches..	60
Track, center line to center line of wheels.....	do....	63. 5
Diameter of turning circle.....	feet..	54

5-INCH, 60-POUNDER GUN, MARK I, AND CARRIAGE, MARK II (BRITISH).

The gun is of the wire wound type and consists of two tubes, jacket, breech bush, breech ring, and several layers of steel wire. The inner tube extends the length of the barrel, the outer tube being shrunk upon it, extending over the rear of the inner tube to form a threaded bearing for the breech bush which receives the breech block. The jacket is fitted over the tubes and extends to the rear, having a threaded section on which the breech ring is received. Several layers of steel wire are interposed between the jacket and tubes, the jacket being shrunk over the wire. The breech ring is provided at the top with a lug, to which the recoil piston rod and the rods of the spring cylinders are secured, being the direct connection between the gun and recoil mechanism, and is provided with lugs at the right side which accommodate the breech carrier. On either side of the jacket longitudinal projections are provided, which engage and slide in corresponding slots in the cradle.

The breech block is of the interrupted screw type, having threaded and slotted sectors. The breech bushing is threaded and recessed to correspond with the sectors on the breech block. The breech mechanism is so arranged that by one pull of the breech lever from left to right the breech screw is unlocked and the screw and carrier swung into loading position. After loading, one thrust of the same lever inserts the breech screw into position in the breech bush and turns it into the locked position.

The breech screw is supported by the carrier, which pivots and is hinged to the lugs provided on the right side of the breech ring.

The firing mechanism is of the "T" type and is fitted with a safety device which prohibits the firing of the gun until the breech is closed. Discharge is by means of a lanyard operated from the right side of the carriage.

The carriage consists of the following major parts: Cradle, including recoil mechanism; top carriage; elevating and traversing mechanisms; trail; brake gear; wheels and axle.

The carriage is constructed on the long recoil principle, having practically a constant length of recoil at all elevations. The length of recoil is approximately 57 inches. The recoil mechanism is placed parallel with, and located above the gun, the gun sliding during recoil and counterrecoil in slides provided in the cradle.

The recoil mechanism being of the hydro-spring type, utilizes two spring cylinders and one hydraulic cylinder, independent of each other, and held in relative position by the cradle. The cradle is cylindrical in form and incloses the breech end of the gun, and is provided with threaded holes at the front and rear for the reception of the spring and hydraulic cylinders, which are screwed into these holes. The three cylinders extend to the rear and engage suitable holes in the breech ring to which they are fastened by connecting pieces, the two spring cylinder rods being retained by nuts, and the hydraulic cylinder rod by an externally threaded collar which passes through the breech ring and engages the thread on the piston rod, the three rods recoiling to the rear with the gun.

The trunnions of the cradle are received in bearings in the top carriage, which in turn is pivoted on the front end of the trail to permit traverse.

Traverse and elevation is accomplished through the medium of handwheels located on the left side of the carriage. The elevating

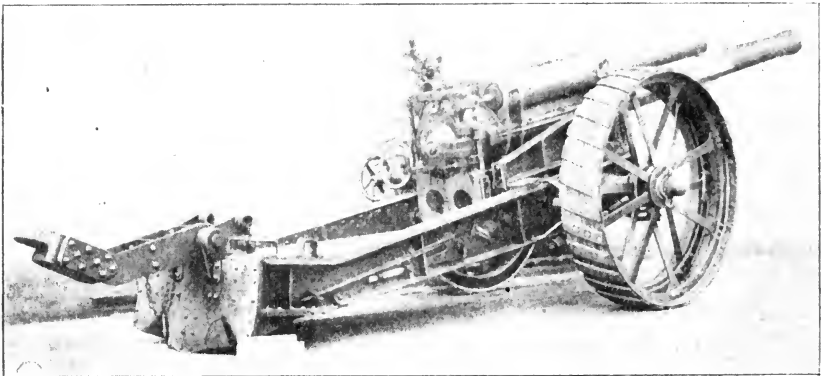

REAR RIGHT VIEW OF CARRIAGE.

handwheel actuates a pinion meshing with a rack bolted to the cradle. The traversing handwheel operates a screw, one end of which is hinged on the top carriage, the other end engaging a nut which pivots on the trail.

Traversing stops are provided on either side of the top carriage to limit the traverse to 4° right and 4° left, when the gun is elevated at $16\frac{1}{2}^\circ$ or less.

The amount of traverse is indicated by a pointer fixed to the trail, which reads to a graduated scale on the rear transom of the carriage.

The trail is of the solid type, being cut out at the front to give clearance to the breech of the gun during recoil, and at high elevations. The front end of the trail is equipped with bronze brackets through which the axle passes. The trail has a bearing at the

forward section on which the top carriage rests and pivots, and through which the pivot pin passes, retaining the top carriage in proper position. Clips are provided on the trail which engage protrusions on the top carriage, preventing vertical movement of the top carriage when the gun is fired. Traversing stops are provided to prohibit traversing of more than 3° left and 3° right, when the gun is elevated above $16\frac{1}{2}^{\circ}$.

The rear end of the trail is equipped with a connector for limbering the carriage to the carriage limber. The connection is held in position by pins, and is provided with holes for adjustment.

A spade of the fixed type is riveted to the rear end, and holds the trail in a practically stationary position when the gun is in action.

A *traveling lock* is provided on the trail which engages the breech of the gun at 0 degree elevation, when traveling. The lock is hinged to the inside of the trail members and swings down when the gun is in firing position.

The *wheels* are of the tractor type, being provided with diagonal cleats riveted to the rims. The wheels are 60 inches in diameter and have tires 12 inches in width.

A *brake ring* is provided on each wheel against which an internal brake shoe is fitted, which is operated by a handwheel at the front of the carriage.

Sighting is accomplished by means of a tangent sight and foresight on the right side of the carriage, and by an oscillating sight and dial sight (panoramic sight) on the left side of the carriage.

The tangent and foresight together form an open sight for the direct laying of the gun.

The oscillating sight on which the dial sight is mounted is used for indirect laying; the oscillating sight being used for laying in elevation and the dial sight for direction.

Ammunition of the separate loading type is used, being both explosive shell and shrapnel. The weight of each is 60 pounds. The propelling charge consists of 9 pounds 7 ounces of cordite. Normally these charges are not separate for zone fire, although special charges are sometimes made up for this purpose.

5-INCH, 60-POUNDER, GUN CARRIAGE LIMBER, MARK II (BRITISH).

The limber consists mainly of a steel frame, two steel chests, wheels, axle, and draft connections.

The vehicle is designed for 2-horse, 4-horse, or tractor draft. When horse drawn, the front end of the frame is equipped with a wooden horse pole, which is retained in place by a pin passing vertically through the rail and pole, and is also equipped with two or four singletrees, as the draft may require. Chains, with the necessary draft connections, are also provided, and extend from two points on the frame to the forward section of the pole, thereby adapting the vehicle for additional horse draft. The necessary neck yoke bars are provided on the draft pole.

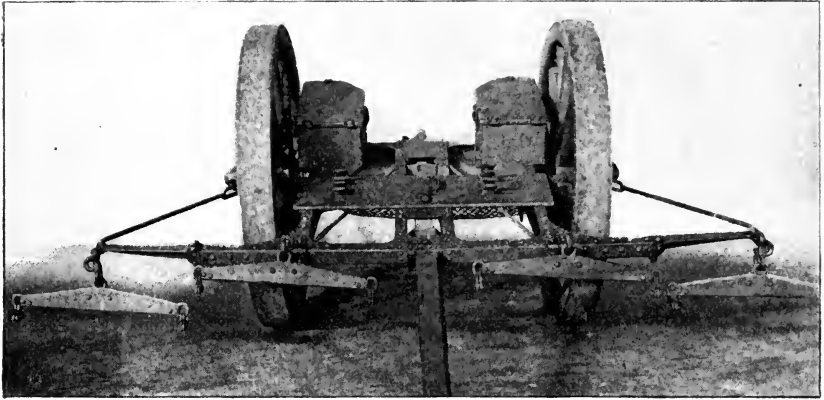

FRONT VIEW OF CARRIAGE LIMBER.

For 4-horse draft, the two outside singletrees are suspended from outriggers which are hinged to the main frame, and are steadied by stays extending back to the axle arms.

For 2-horse draft, the two outside singletrees are removed, the stays disconnected, and the outriggers folded back and over the main frame, being held in the latter position by straps.

The singletrees, when removed, are strapped across the center of the frame forward of the steel chests.

For tractor draft, all the singletrees are removed and strapped to the frame, the horse pole being removed and replaced by the motor draft connector, which is pinned to the frame.

The frame consists principally of four side rails, two inner and two outer, connected at the rear to the axle by flanges and pins. The front end is joined together by connecting plates, the frame being strengthened by diagonal stays.

In the rear of the frame at the center, a pintle is provided, which accommodates the adjustable connector on the trail of the carriage in traveling position. The pintle is provided with a thumb latch which prevents accidental unlimbering of the trail connector.

The steel chests are riveted to the main frame at the rear, on either side. The inner rear corners of these chests are formed diagonally

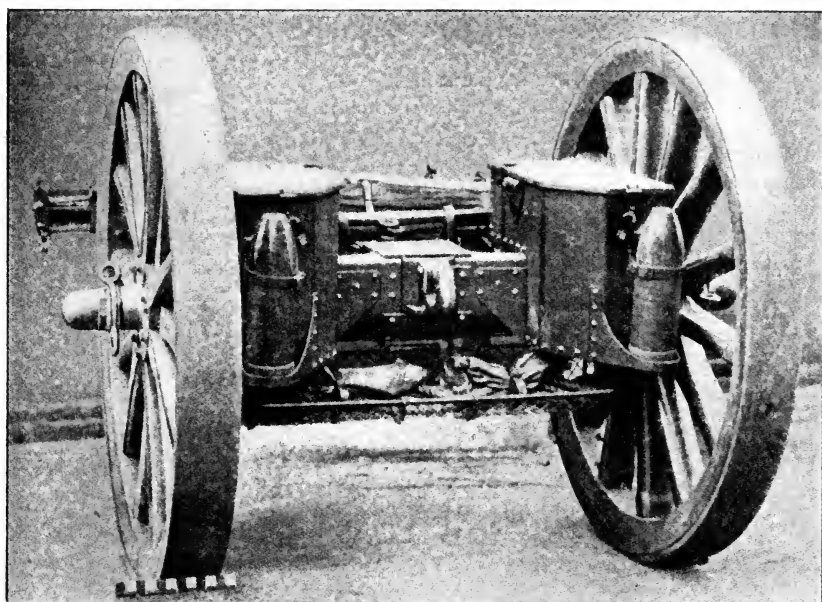

REAR VIEW OF CARRIAGE LIMBER.

to allow clearance to the swing of the connector on the carriage, when traveling.

The chests are of flanged steel, having lift lids which are hinged at the front side and are equipped with hasps, locks, and chains at the rear. The interior of each chest is fitted for carrying stores, and each is provided at the top with a tray which carries small stores. The left chest is constructed to carry the sights and attachments, together with a number of small tools, and one powder charge in a tin box. The right chest carries the clinometer, oil can, and other various tools and accessories, together with one powder charge in a tin box.

Extending from the base of each chest toward the rear a steel bracket is provided on which one round of ammunition is carried.

The shell is held in a vertical position on this support by a bronze bracket and a strap.

Suspended below the frame at the rear, a wire net tray is provided for carrying drag ropes and lashings.

Forward of the steel chests, on the top of the frame, a board is fastened, extending across the frame, and is equipped with friction clips for the accommodation of two rifles.

The wheels provided are 60 inches in diameter, having steel tires 6 inches in width. The outer end of the axle arms are equipped with drag washers to assist hauling. No brakes are provided on this vehicle.

Weights, dimensions, etc.

Weight without two projectiles.....	pounds..	2,240
Weight on limber pintle, traveling position.....	do....	641
Weight on pole, carriage limber (at center tug hole):		
Without two projectiles.....	do....	51
With two projectiles.....	do....	39
Diameter of wheels.....	inches..	60
Track of wheels, center line to center line.....	do....	63.5
Length:		
With horse pole.....	do....	186
Without horse pole.....	do....	77
Width:		
Over axle with dust caps.....	do....	78.5
Outriggers extended.....	do....	110
Outriggers folded.....	do....	65

5-INCH, 60-POUNDER, AMMUNITION WAGON MARK II (BRITISH).

The ammunition wagon (caisson) consists principally of a steel frame, ammunition chest, fuze lockers, brake gear, draft fittings, wheels, and axle.

The wagon is constructed to carry 24 rounds of ammunition, 24 powder charges in tin containers, and 2 fuze boxes. The exterior is fitted with fastenings to carry ropes, handspikes, also other tools and accessories.

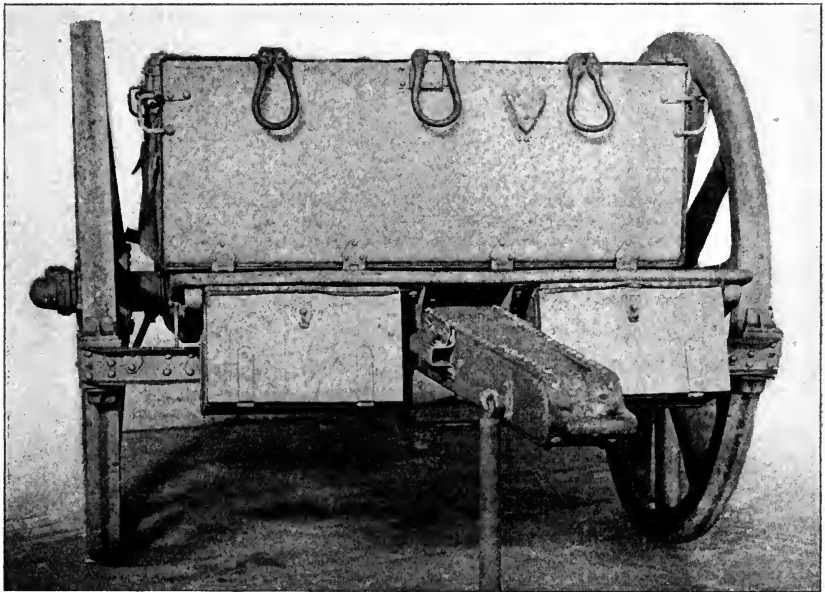

FRONT VIEW OF AMMUNITION WAGON.

The ammunition chest is constructed of flange steel, having flange steel brackets on either side at the center, which extend below the chest, providing bearings which receive the axle.

The interior of the chest is divided into a front section and a rear section, by a vertical steel plate, passing through the chest, parallel to the axle. Each section is divided by steel plates passing crosswise through the chest into three horizontal rows of compartments. The lower compartments contain 4 high explosive shell and 4 shrapnel. The middle row contains 2 high-explosive shell, 2 shrapnel, 2

powder charges in tin containers, 1 fuze box containing 14 fuzes, and 1 empty compartment. The upper row of compartments contain 10 powder charges in tin containers.

The powder charge containers, and the shell are retained in the proper position by quick release straps, and the shell are withdrawn from their respective compartments by means of the packing blocks which inclose the nose of the shell, and by the withdrawing straps provided. The withdrawing straps extend the length of the shell and are fastened to the nose blocks, and are also riveted to the compartment plates, preventing their complete removal. When the

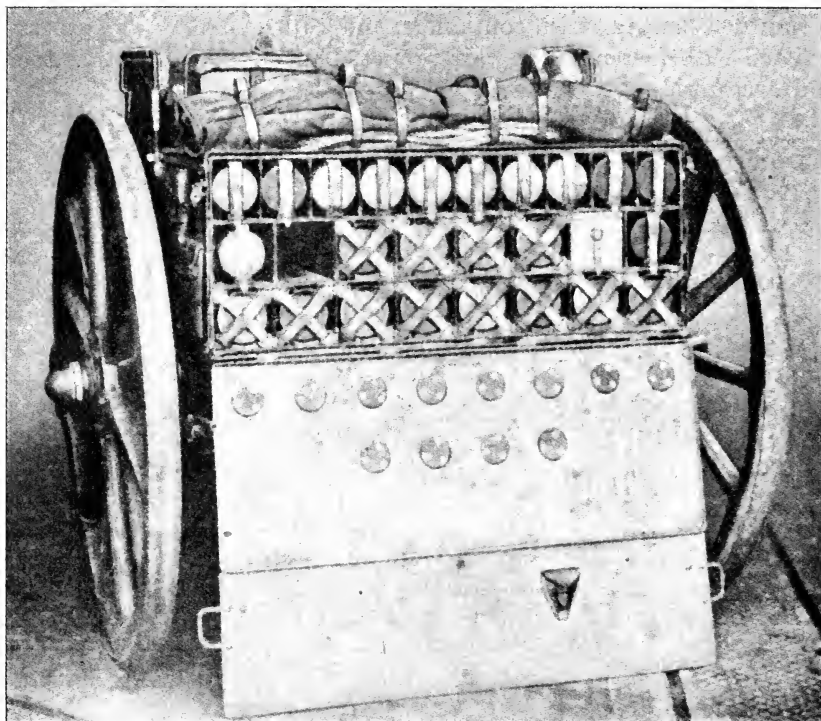

REAR VIEW OF AMMUNITION WAGON.

shell is withdrawn about half its length, the withdrawing strap is slipped over the base of shell allowing the complete removal of the shell, while the packing blocks and straps are held in their respective compartments. The powder charge containers can be lifted out without the aid of straps.

The front compartment is equipped with a steel door which is hinged at the bottom and swings downward when opened. The rear compartment is equipped with an armor-plate door hinged at its lower edge, and when opened hangs vertically downward. The front door when opened downward is supported by the footboard

in a horizontal position. Each door when closed is held in position by latches provided on the sides of the chests, which swing over and engage steel handgrips riveted on either edge of the door at the top.

Extending above the chest at the front on either side, handrails are provided. The rails are constructed of steel and are provided with leather guards. The rails fit into small brackets riveted to the chest sides, and may be dismantled from the chest by removing the retaining pins. Three grip straps are also fastened to the upper front edge of the chest to assist the personnel when mounting the vehicle.

Straps are provided with the usual fastenings, at the top of the chest to accommodate the soldiers' personal equipment, and also picket ropes, at the rear. At the front of the chest the fastenings accommodate blankets, lamps, and tool cases. On either side of the chest fastenings are provided, the left side accommodating a saw in a leather case, and the right side a spanner wrench.

The frame consists of two flanged sides connected by cross stays to the draft pole, which consists of two flange steel members extending back, the length of the vehicle. The outside rails are provided with flanges and holes through which the axle passes. The chest is mounted on the frame, the axle brackets on the chest corresponding with the flanges on the side rails, making a solid bearing for the axle, which is held in place by keys.

Forward of the chest, across the side rails, a wooden footboard and platform is provided. Suspended below the footboard on either side, is a fuze locker, which provides carrying compartments for 30 fuzes, 15 in each locker. Each locker is provided with a door, which swings downward when opened, and each is equipped with a hasp and a pivot thumb lock.

Suspended from the platform to the rear of the right fuze locker, a tin box, containing 3 pounds of grease, is strapped.

The frame is provided at the rear with a steel prop which swings up to the right side of the frame and is retained in this position by a spring clip when in traveling position.

Wire-net receptacles are suspended under the rear section of the frame on either side of the prop bracket. The receptacles provide space for canvas watering buckets and ropes.

The draft pole, which is an extension of the center rail of the frame, is joined at its extreme forward end by a lunette, which engages the pintle on the ammunition wagon limber when in traveling position. A pole prop is also provided for supporting the draft pole when the wagon is unlimbered. The prop swings up to a horizontal position when the wagon is in traveling position. Attachments on the underside support a jointed draft pole and a handspike.

Tire brakes are provided for each wheel, the brake system being operated as one unit. The shoes which bear against the wheel are supported by brackets fastened to the side rails at the front.

The shoes are operated by a crank located on the left rear side of the vehicle under the frame. The crank is connected to the shoes by rods supported on the frame.

Wheels of the wooden type, 56 inches in diameter, having steel tires 3 inches in width, are provided on this vehicle. They are retained on the axle by means of an adjusting collar and linch pin.

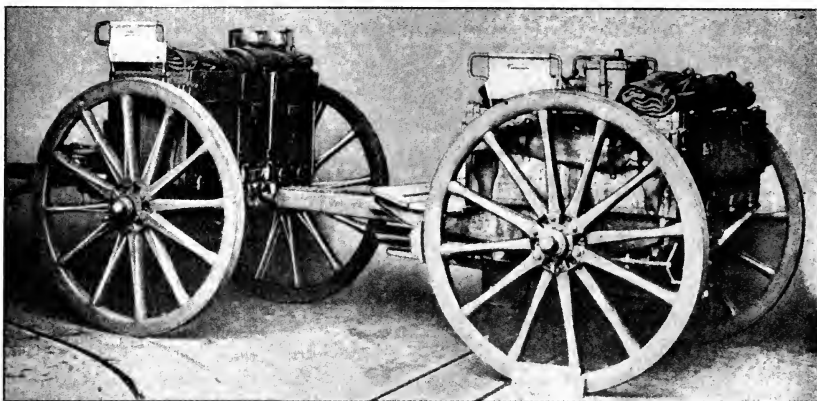

AMMUNITION WAGON AND AMMUNITION WAGON LIMBER, LIMBERED.

The bearing is protected from dirt and other foreign matter by a dust cap which fastens over the end of the hub box.

Drag washers are provided on each wheel to which ropes may be fastened to assist in the maneuvering of the vehicle.

Weights, dimensions, etc.

Weight of wagon, empty.....	pounds..	1, 732
Weight of wagon, loaded and equipped.....	do....	3, 556
Pressure of wagon pole on limber pintle, loaded.....	do....	98
Pressure of wagon pole on limber pintle with two men on wagon, loaded.....	do....	196
Height to top of handrail.....	feet.....	5. 229
Height, handrails removed.....	do....	4. 416
Width, maximum.....	do....	6. 291
Length of wagon.....	do....	9. 708
Greatest projection beyond track of wheels.....	inches..	6. 25
Wheel track.....	do....	63
Diameter of wheels.....	do....	56

5-INCH, 60-POUNDER, AMMUNITION WAGON LIMBER, MARK II (BRITISH).

The limber comprises the frame with pintle; ammunition chest; fuze locker; draft fittings; wheels and axle.

The limber is designed to draw the ammunition wagon by means of the pintle provided at the rear. The vehicle is equipped for 2-horse draft. It carries 16 rounds of ammunition together with the necessary powder charges. Provision is also made to carry 43 fuzes, 28 of which are carried in the ammunition chest, and the remainder in the fuze locker fastened to the top of the chest. Implement fastenings are fastened on the exterior of the chest and foot-

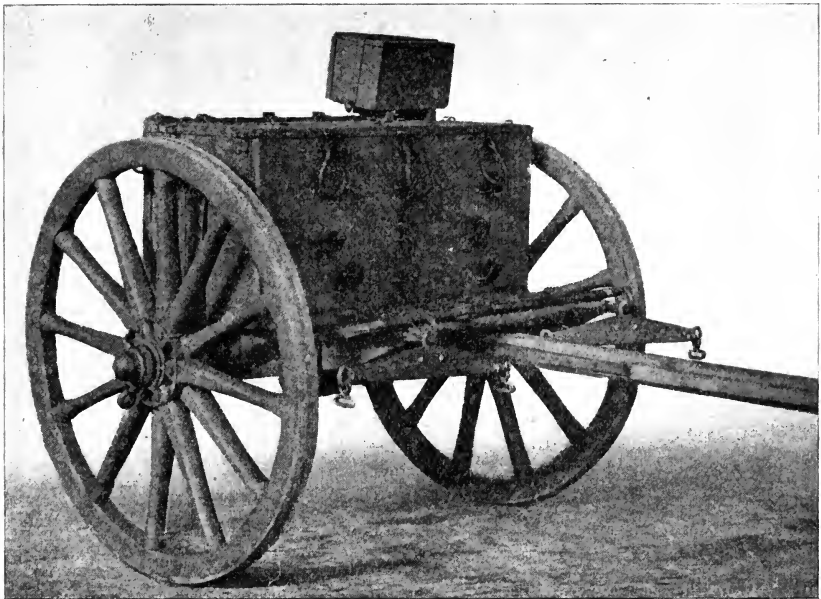

FRONT VIEW OF AMMUNITION WAGON LIMBER.

board, and accommodate rifles, blankets, and the customary tools and accessories.

The chest is constructed of steel and is provided at the rear with three doors. The interior of the chest is subdivided by two steel plates into three main divisions, access to each being at the rear.

Each division is separated by cross plates into four rows of compartments, the lower two rows of each division being subdivided into smaller compartments to accommodate a total of eight high explosive and eight shrapnel shells.

The two upper rows of the two outside divisions are constructed to accommodate a total of 16 powder charges, each protected by tin containers.

The two upper rows of compartments in the middle division accommodate a tray for small stores, such as cotton waste, pins, pliers, and other small tools; and 2 fuze boxes, each containing 14 fuzes. The fuze boxes occupy the upper row of compartments.

The powder-charge containers and the shell are retained in place in the chest by quick-release straps, and the shells are withdrawn from the compartments by withdrawing straps and blocks, identical with those on the ammunition wagon.

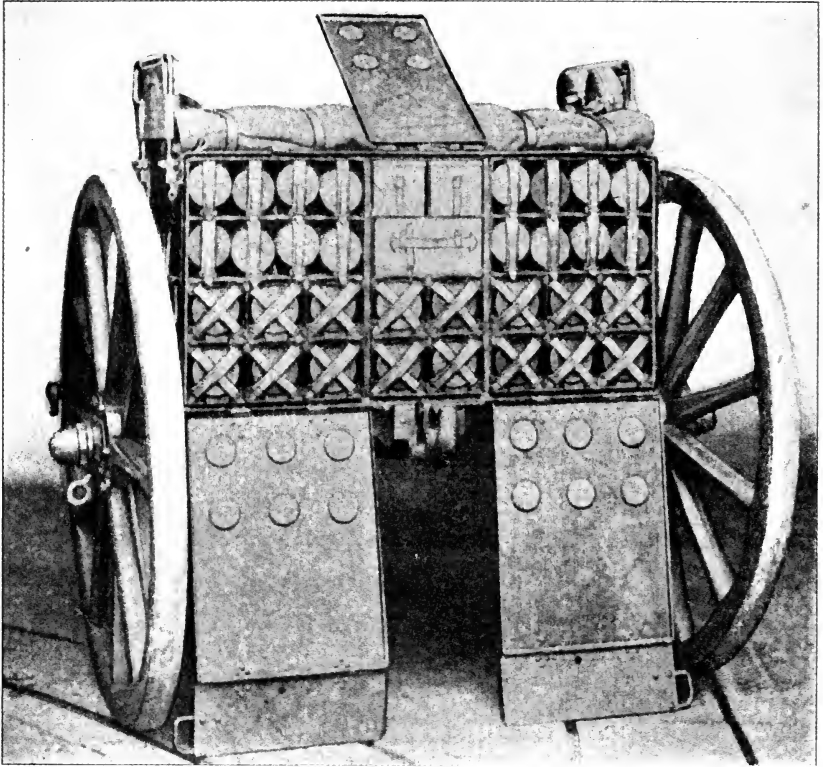

REAR VIEW OF AMMUNITION WAGON LIMBER.

A door is provided at the rear of the chest for each main compartment. The two outer doors are of armor plate and have hinges at the bottom edges, and when opened hang down vertically from the chest. A small armor-plate apron is hinged to each door at its upper edge. The aprons hang vertically from the door when each door is opened, and form an extension toward the ground, thereby giving additional protection for the personnel serving the gun. When the door is in closed position, the aprons fold down over the outside of the door and are retained in position by latches fastened to the upper part of the chest, which engage steel hand grips riveted to the aprons.

The middle compartment is equipped with a steel door which is hinged at the upper edge, and when opened, rests over the top of the chest: The spring latches with thumb lift grips are riveted to the door which engage suitable latches on the lower edge of the chest when the door is in the closed position. Two small clips which extend over the edge of the side, at the lower sides, act as retainers for the outer doors when they are closed.

In operation the middle door is first opened, thereby removing the clips which bear against the outside doors, allowing the outer doors to be swung open. In closing the chest the two outer doors are closed first.

Handrails, protected by leather, are provided on either side of the chest, and extend above the chest. They engage suitable brackets riveted to the chest, to which they are fastened by pins. By the removal of the retaining pins, the handrails may be dismantled from the chest.

The exterior of the chest is fitted with implement fastenings and straps, the front plate having spring catches for three rifles. Three grip straps are fastened to the upper edge of the chest at the front, to assist the personnel in riding on this vehicle.

Three leather pockets, one on the rear middle door and one on either side of the chest, are provided for carrying fuze and limber keys.

A wooden locker for carrying fuzes is fastened by steel straps to the top of the chest on the left side. The locker is equipped with a lift lid, hinged at the front and provided with a hasp and thumb lock at the front. The interior is constructed to carry 15 fuzes. Two blankets, which serve as a seat cushion, are strapped to the top of the chest at the front, and the soldiers' personal equipment is strapped at the rear.

Each side of the chest has riveted thereto a steel bracket, which extends below the chest body, and is provided with an opening through which the axle passes.

The frame which supports the ammunition chest consists mainly of two side rails, two middle rails, and the connecting cross rails.

The middle rails are connected at the front of the frame to form a seat for the wooden horse pole. The outer rails converge slightly at the front, and with the middle rails form a support for the wooden platform and footboard. Two of the cross rails extend across the frame, directly beneath the edges of the chest, giving a solid support to which the chest is fastened. The other cross rail extends across the extreme front of the frame and is fitted with hooks for the support of two singletrees. A wooden horse pole, equipped with a neck yoke bar, is provided.

Forward of the chest a wooden footboard and platform is fastened to the upper side of the frame. The boards have staples for the

accommodation of leather straps, which secure rope lashings; shovels, and other similar equipment to the footboards.

On the under forward right side of the frame a case is provided to carry a bolo. On the left side of the frame, in a corresponding position, a case is provided, to carry a water brush.

Suspended from under the wooden platform, on the left side, is a box containing 3 pounds of grease. Under the right side of the platform, fastenings are provided to carry two cans containing lubricating oil.

A pintle, which engages the lunette on the draft pole of the ammunition wagon, is provided in the frame at the rear.

In each side rail at the rear a hole is provided which forms a bearing for the axle. The steel axle bracket on the sides of the chest correspond with these holes, and form a solid bearing for the axle, which is held in place by keys.

Wheels of the wooden type, 56 inches in diameter, having steel tires 3 inches in width, are provided. An adjusting collar and linchpin screws the wheel to the axle. Protection against the ingress of dirt and foreign matter is provided by a dust cap which fastens over the end of the hub box.

Drag washers to assist in the maneuvering of the vehicle are provided on each wheel.

The wheels and axle of the limber are interchangeable with those on the ammunition wagon. No brake is provided on the ammunition wagon limber.

Weights, dimensions, etc.

Weight of limber, empty.....	pounds..	1, 416
Weight of limber, loaded and equipped.....	do....	2, 632
Weight of wagon and limber, empty.....	do....	3, 148
Weight of wagon and limber, loaded.....	do....	6, 188
Weight of limber only, with wagon limbered up, empty.....	do....	1, 486
Weight of limber only, with wagon limbered up, loaded.....	do....	2, 730
Weight of limber pole at position of center tug hole with wagon limbered up, loaded, without men.....	pounds..	14
Weight of limber pole at position of center tug hole with wagon limbered up, loaded, with 2 men on limber only.....	pounds..	35
Weight of limber pole at position of center tug hole with wagon limbered up, loaded, with 2 men on limber and 2 men on wagon.....	pounds..	25
Length of limber with pole.....	feet..	14. 166
Length of limber without pole.....	do....	5. 5
Length of limber and wagon, overall.....	do....	22. 687
Length between axles of limber and wagon.....	do....	8. 25
Height of limber to top of handrails.....	do....	5. 666
Height of limber, handrails removed.....	do....	4. 895
Width of limber, maximum.....	do....	6. 291
Wheel track of limber.....	inches..	63
Diameter of wheels of limber.....	do....	56
Diameter of turning circle of limber and wagon.....	feet..	23. 5

155-MILLIMETER HOWITZER MATÉRIEL, MODEL OF 1917 (SCHNEIDER).

Recent experience indicated the necessity of artillery of larger caliber than the 75 millimeter, having a longer range and better characteristics, yet mobile enough to permit its use by combat divisions. This necessity led to the adoption of the 155 millimeter caliber corresponding to 6.10-inch artillery. The importance of this 155-millimeter howitzer is evident when it is realized that it is the largest weapon at the present time that can be used by combat divisions, and is especially valuable for use against captive balloons, counter battery firing, and interdiction.

The type of 155-millimeter howitzer carriage adopted is known by the French as the 155 millimeter Court Schneider, model of 1917, and by the United States as the 155-millimeter howitzer carriage, model of 1918 (Schneider). The howitzers manufactured in the United States



RIGHT SIDE VIEW OF CARRIAGE IN TRAVELING POSITION.

are also distinguished from those made in France by the designation "Model of 1918." The American matériel differs from the French in having a straight shield instead of a curved one, rubber instead of steel tires, a slightly different firing mechanism, and several other minor changes. The howitzer is mounted on a carriage having a single trail composed of two pressed steel flasks. At the front end these are connected by the axle housing and at the rear by a fixed spade. The carriage embodies many ingenious features designed to reduce the weight and insure stability.

The recoil mechanism is of the hydropneumatic type, the sleigh recoiling with the howitzer. In recoiling the liquid is forced from one side of the piston to the other through a variable orifice which gradually closes until the howitzer is brought to a stop. The return of

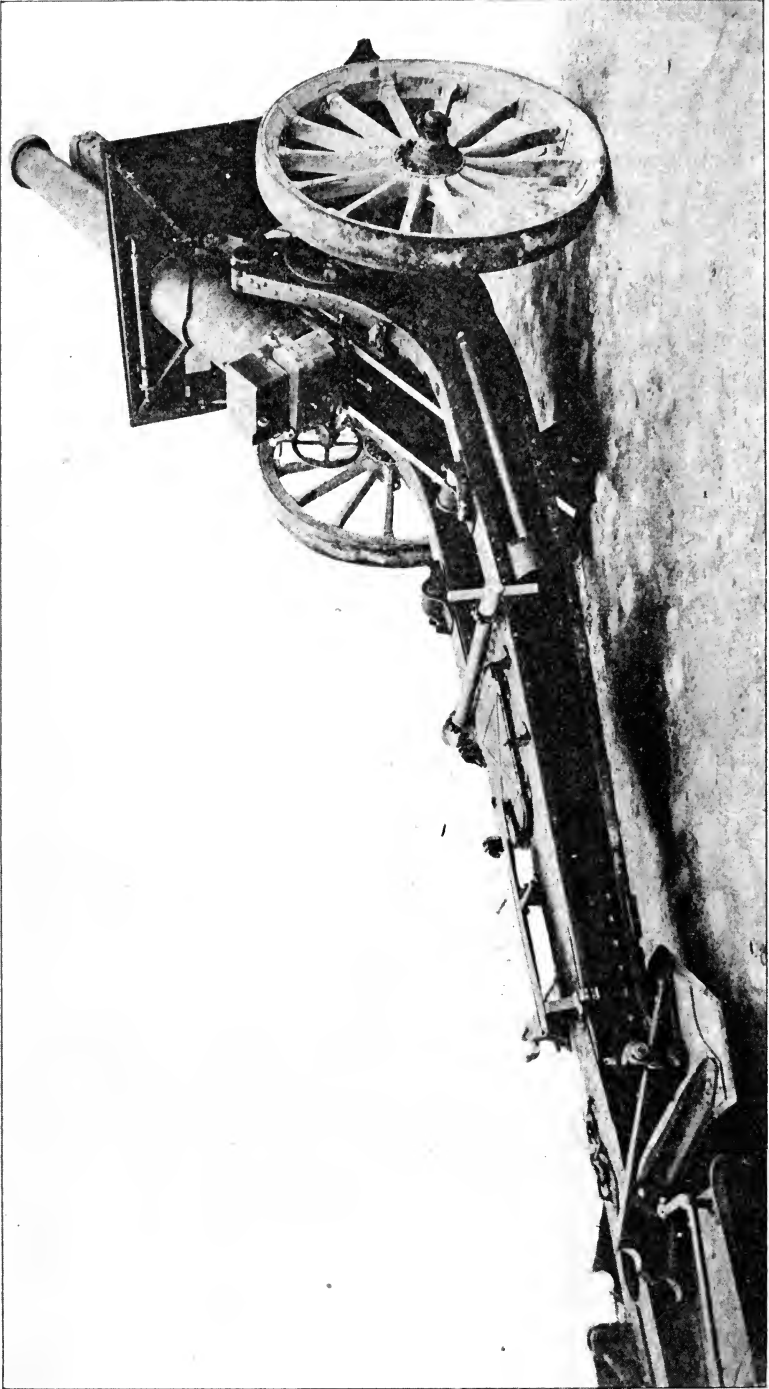

155-MILLIMETER HOWITZER CARRIAGE, MODEL OF 1917, IN BATTERY POSITION.

the howitzer into battery is effected by the expansion of the air compressed during recoil. The length of recoil is practically constant, and in order to allow the howitzer to be fired at high elevations without digging in the trail, the trail is made of a curved shape.

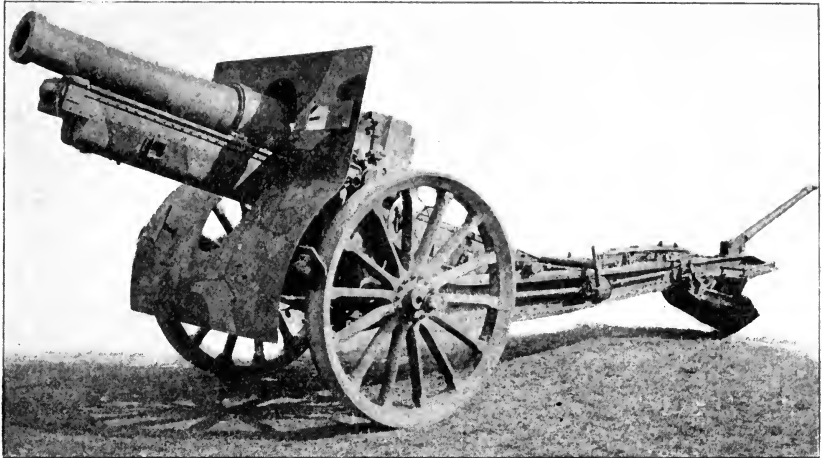

FRONT VIEW OF CARRIAGE IN BATTERY.

By sliding transversely along its axle the howitzer is capable of traversing through a total angle of 6° . Its maximum elevation is approximately 42° . It fires a 95-pound projectile with a muzzle velocity of about 1,480 feet per second to a maximum range of about 12,300 yards. Separate loading ammunition is employed. By the use of the reduced powder charges, shorter ranges are reached with

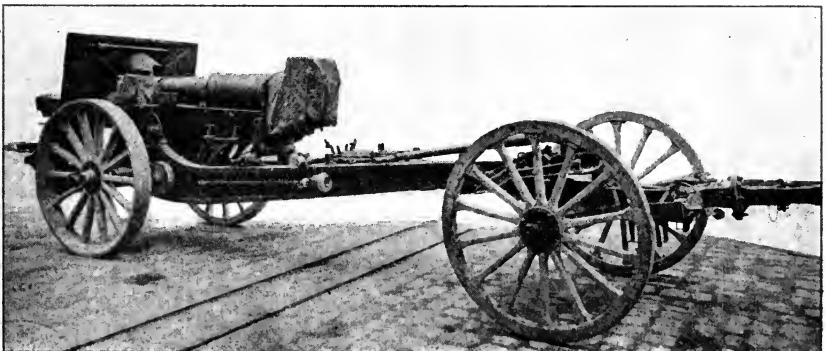

SIDE VIEW OF CARRIAGE EN ROUTE.

steep angles of fall and with less wear on the gun. Its life, before relining is necessary, is approximately 7,000 rounds.

The entire equipment is motorized and the equipment for each howitzer includes a carriage limber, used when traveling to support the trail, three caissons or ammunition vehicles, and a number of ammunition, repair, and supply trucks.

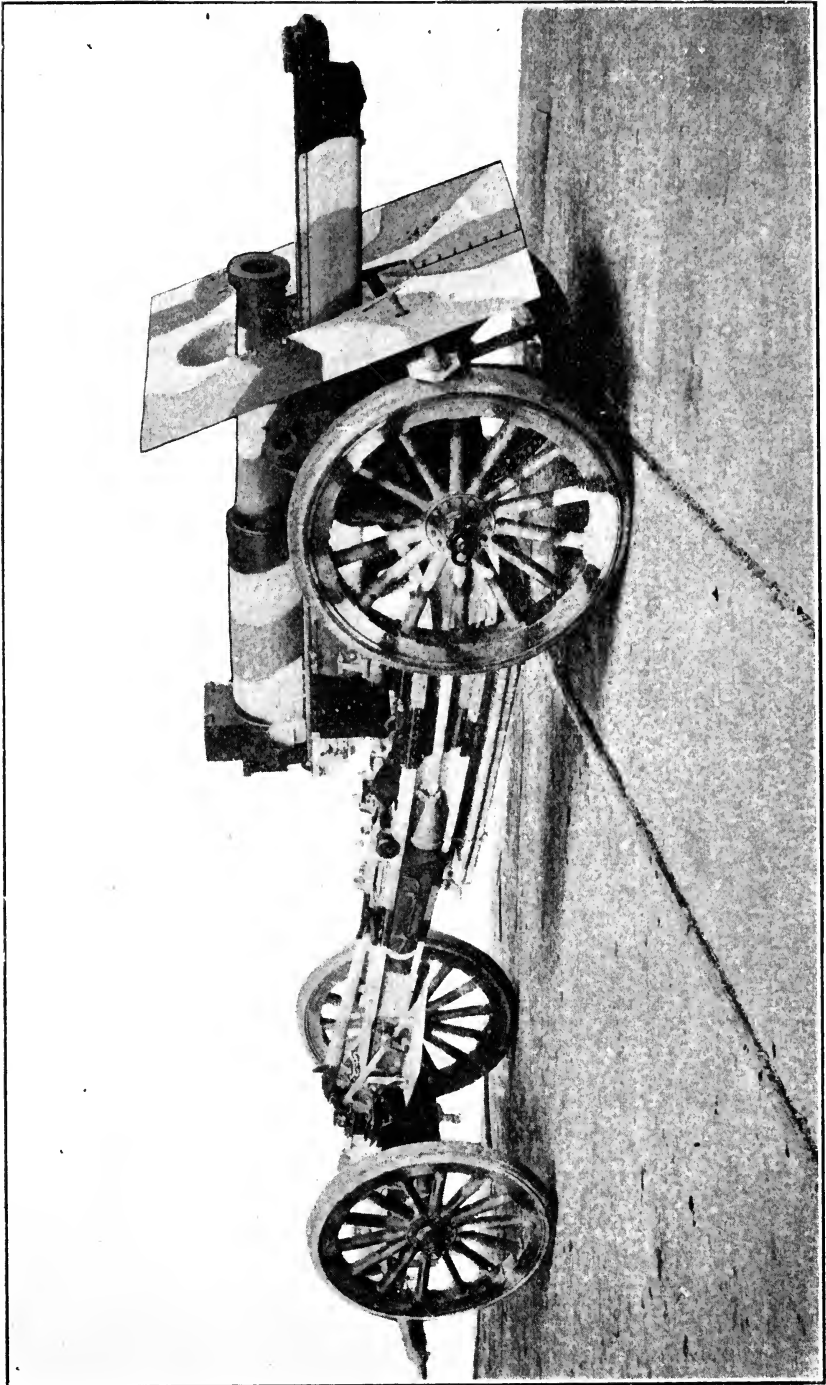

155-MILLIMETER HOWITZER CARRIAGE, MODEL OF 1918 (SCHNEIDER). TRAVELING POSITION.

155-MILLIMETER HOWITZER MATÉRIEL, MODEL OF 1918 (SCHNEIDER).

The 155-millimeter howitzer, model of 1918 (Schneider), is of the hydropneumatic long-recoil type, which may be used for direct fire, but was specially designed for indirect fire. On account of its high trajectory it is able to direct shells on targets inaccessible to field guns of limited elevation.

This howitzer has given satisfactory results in actual service and has proven to be superior to other howitzers of similar caliber. It has a muzzle velocity of 1,480 feet per second and attains a maximum range of 12,300 yards, the projectile weighing approximately 95 pounds.

A maximum rate of fire of four rounds per minute may be attained, but heating as well as difficulty of preparing and serving of ammunition by the gun crew renders such rate impossible for any length of time, however. The normal rate of fire is two per minute.

The howitzer is mounted on a sleigh and rigidly secured by a breech key and a holding-down band. The sleigh contains the recoil mechanism which permits long recoil and insures stability at low elevations. When the gun is fired, the sleigh recoils on bronze slides on the cradle, which is a U-shaped steel plate and rests on the trunnion bearing of the trail.

This howitzer may be elevated from zero to 42° by means of the elevating mechanism. The traverse is 52.5 mils to the right and left, the carriage sliding on the axle and pivoting on the spade, which prevents the carriage from recoiling when the gun is fired. The customary shield affords protection for the gunners from shrapnel and flying fragments.

In traveling position the howitzer is retracted and locked to the cradle, the cradle locked to the trail, the spade revolved and secured to the bottom of the trail. The lower end of the trail rests on the carriage limber, which is used to carry its proportionate share of the load of the howitzer and carriage in traveling position. The limber is equipped with a connecting pole for motor traction. The carriage and limber wheels are rubber tired and considered able to negotiate any roads suitable for field artillery.

This matériel consists of:

The 155-millimeter howitzer and carriage, model of 1918 (Schneider).

The 155-millimeter howitzer carriage limber, model of 1918 (Schneider).

The 155-millimeter howitzer caisson, model of 1918 (Schneider).

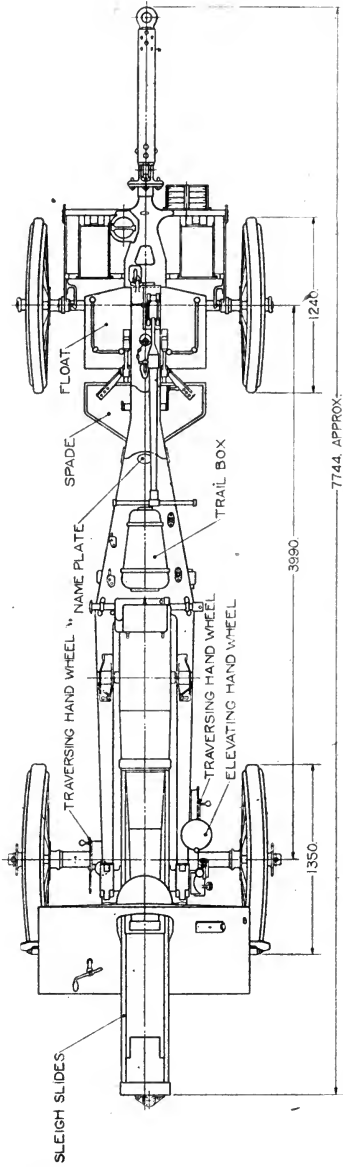

7744. APPROX.

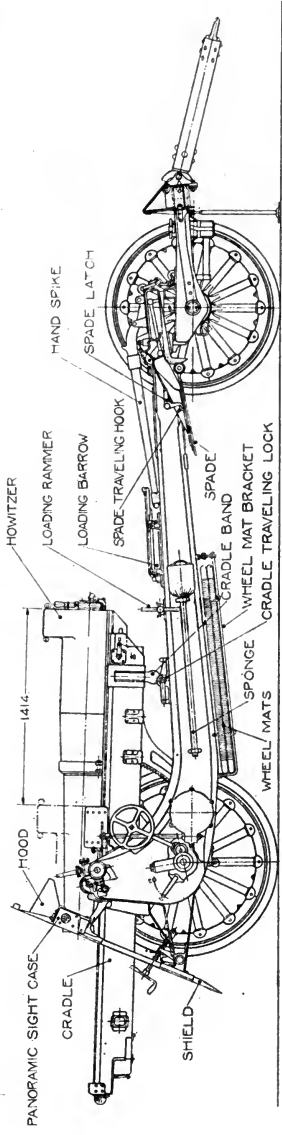

155 MM HOWITZER, MODEL OF 1918 (SCHNEIDER)
TRAVELING POSITION

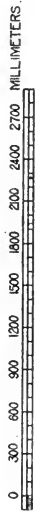

The howitzer, carriage, and limber are of the French design and were manufactured in the United States.

The caisson is of American design and manufacture. This matériel is used with motorized batteries, and a full complement of tractors and trucks is provided for the transportation and service of the battery.

The cart, model of 1918, and reel, model of 1909M1, described with the 75-millimeter matériel, are also used with this matériel.

Weights, dimensions, ballistics, etc.

Weight of howitzer, including breech mechanism.....	pounds..	2, 690
Caliber	inches..	6. 10
Total length	do	91. 0
Weight of projectile.....	pounds..	95
Weight of maximum powder charge.....	do....	8
Muzzle velocity of shell.....	feet per second..	1, 476
Muzzle velocity of shrapnel:		
Minimum.....	do....	666
Maximum.....	do....	1, 434
Maximum range of shell.....	yards..	12, 250
Maximum range of shrapnel.....	do....	10, 700
Weight of howitzer and carriage, fully equipped.....	pounds..	7, 600
Weight of carriage complete, but without equipment.....	do....	4, 729
Diameter of carriage wheels.....	inches..	53
Width of carriage track.....	do....	60
Normal length of recoil.....	do....	51. 30
Elevation.....	0° to 42°	20
Maximum traverse (3° (52½ mils) right and 3° (52½ mils) left).		
Weight of limber, completely equipped.....	pounds..	1, 440
Diameter of limber wheels.....	inches..	42. 82
Width of limber track.....	do....	61
Turning angle of 155-millimeter howitzer, limber and carriage limbered.....		
.....	degrees..	52

155 M.M. HOWITZER
MODEL OF 1918
(SCHNEIDER)

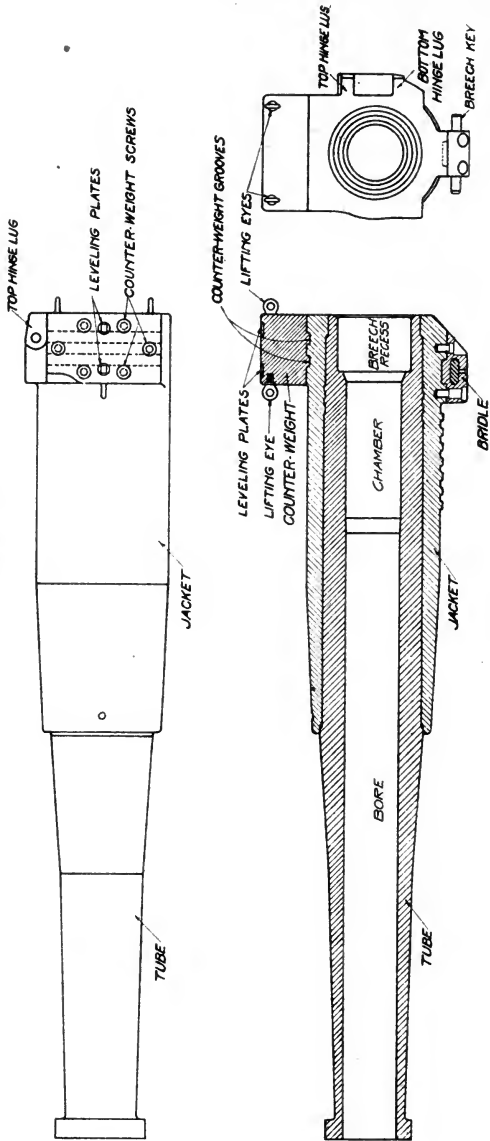

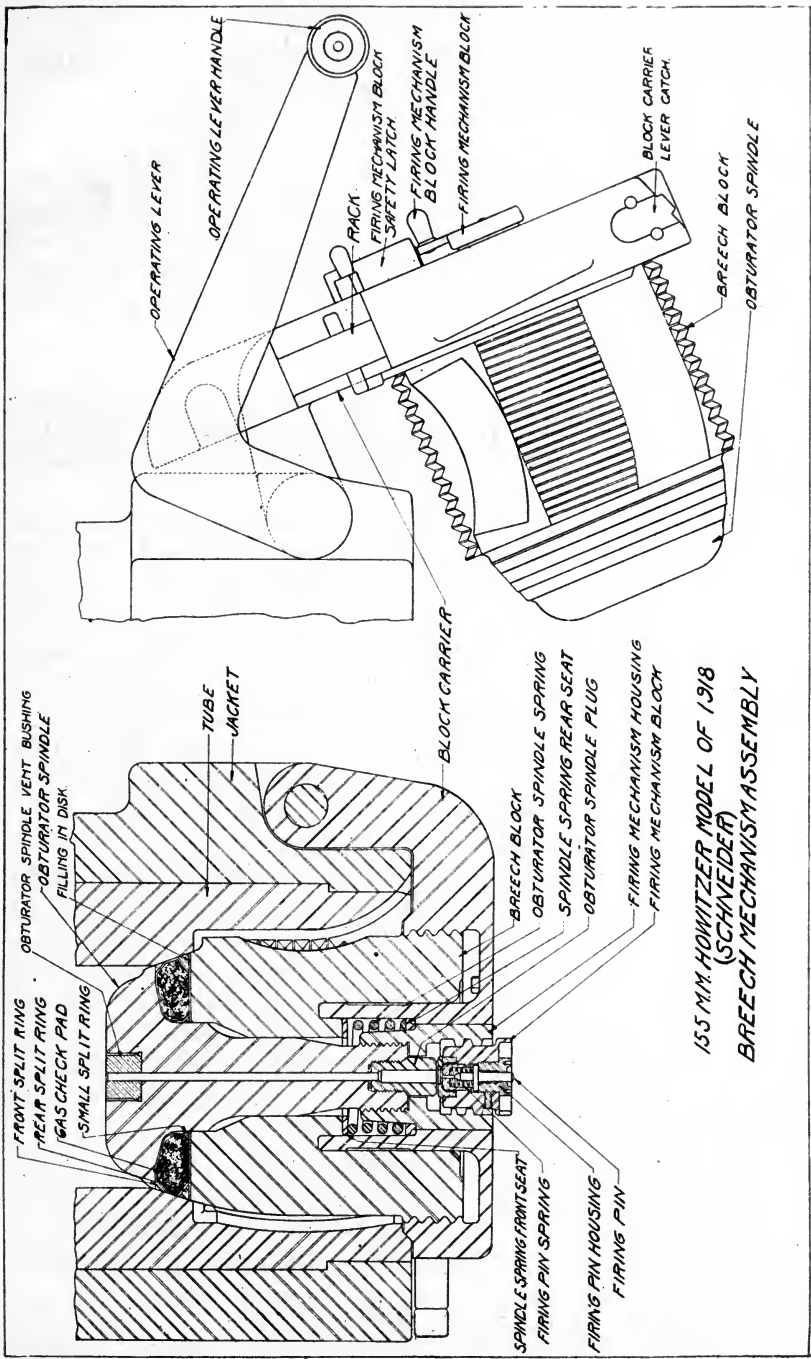

155 M.M. HOWITZER MODEL OF 1918
(SCHNEIDER)
BRECH MECHANISM ASSEMBLY

155-MILLIMETER HOWITZER AND CARRIAGE, MODEL OF 1918 (SCHNEIDER).

The howitzer is of the built-up type and consists of a tube and having a jacket shrunk over its rear half. The breech end is equipped with a counterweight which is fitted with leveling plates to be used with a gunner's quadrant when setting elevations. Below the breech recess is the bridle which couples the gun to the sleigh and on the forward end of the howitzer a holding down band also functions to secure the tube to the sleigh.

The breech mechanism is of the plastic obturator type with an interrupted screw type breechblock. The breechblock is hinged at the right and by means of one motion of the breech lever can be rotated and swung clear of the breech.

The forward mushroom-shaped head of the breechblock is equipped with a flexible asbestos ring known as the obturator pad. The gas check pad or plastic obturator is composed of a mixture of one part asbestos and three parts nonfluid oil, contained in a canvas covering. The pad is protected by the front, rear and small split rings. A steel filling-in disk is placed between the gas check pad and the breechblock. On firing, the asbestos ring is compressed and acts as a gas check to prevent the leakage of powder gases back through the breech. The asbestos pad, by its shape, causes the split rings to spread when pressure is applied on the mushroom head. It has sufficient resiliency to resume its original form after firing.

The firing mechanism is of the French percussion primer type. The primer is fired by means of the firing pin driven forward by a hammer operated by the lanyard. The firing pin is supported in the firing mechanism block, which is unscrewed each time a new primer is inserted. A safety device is used in connection with the firing mechanism block, which makes it impossible to unlock the breech while the block is in position, or to insert the block while the breech is unlocked. The firing mechanism block is interchangeable with those used in the following weapons:

155-millimeter gun, model of 1918 (Filloux).

8-inch howitzer (Vickers Mark VI and VIII $\frac{1}{2}$).

240-millimeter Howitzer, model of 1918 (Schneider).

The recoil mechanism is of the hydropneumatic long recoil type. With this howitzer the type of recoil is known as constant, i. e., the length of recoil is not shortened at high elevations. The sleigh contains the recoil mechanisms and serves as a support for the

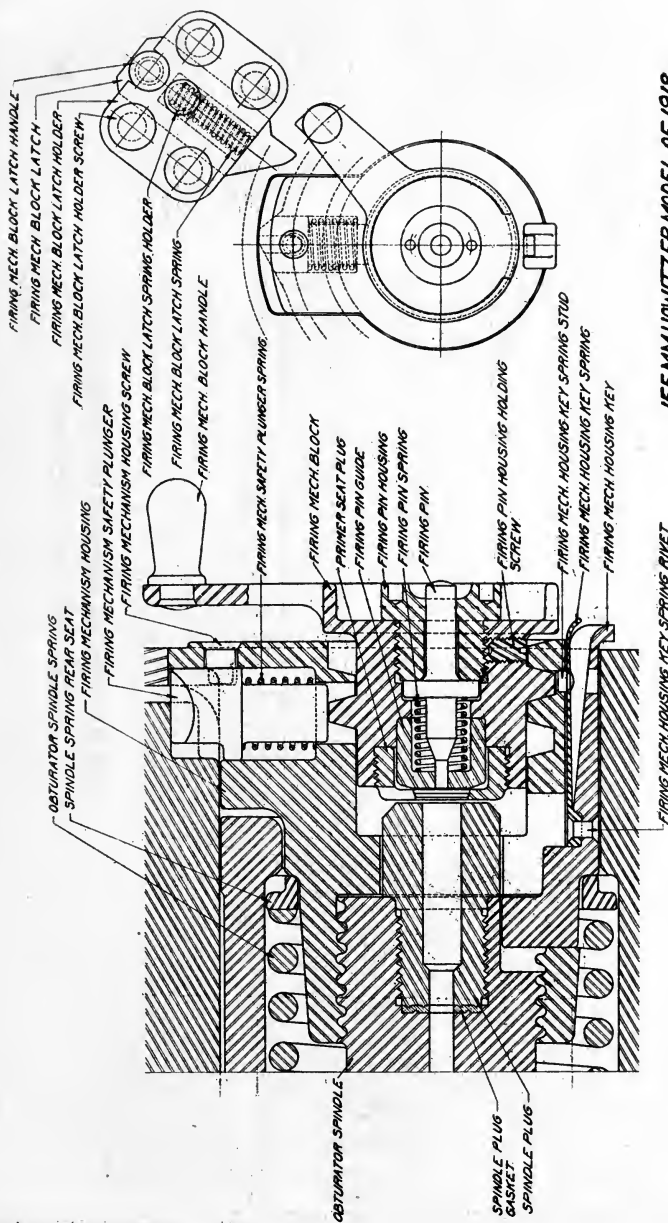

155MM HOWITZER MODEL OF 1918
 (SCHNEIDER)
 FIRING MECHANISM

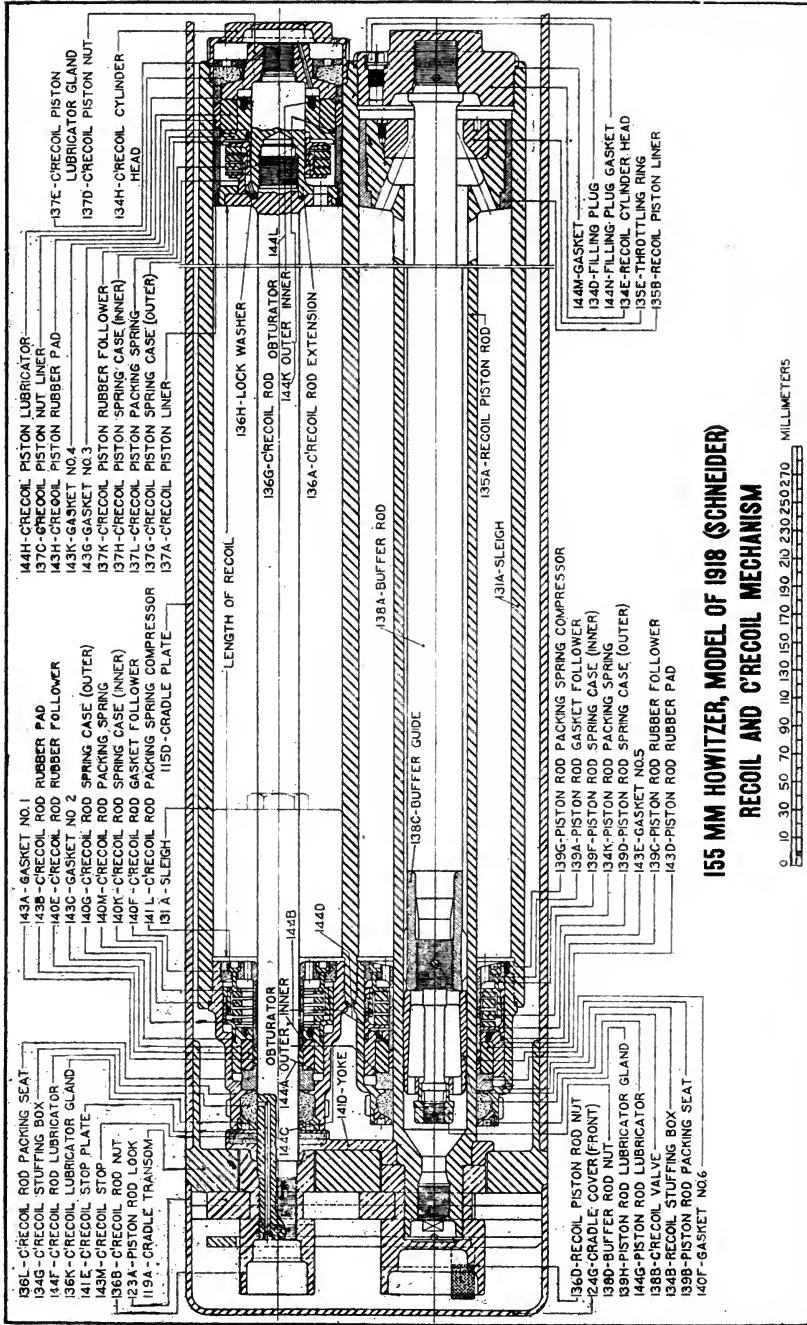

howitzer, being secured to it by the breech lug and the holding down band. On recoiling, howitzer and sleigh move on the cradle fastened to the trunnions of the carriage, the piston rods remaining stationary.

A mixture of glycerine and water (boiled) is used in the recoil brake and to that mixture caustic soda is added for the counterrecoil mechanism. The gas used in the counterrecoil mechanism may be either air or nitrogen.

Nitrogen is always used when available, as it has no corrosive action on the mechanism. The energy of recoil is absorbed by the friction of the liquid while passing through the openings in and around the recoil piston and by the compression of the nitrogen in the cylinders. The howitzer is returned to battery by the energy stored in the compressed nitrogen which forces the liquid out and reacts against the counterrecoil piston. When in battery, the initial nitrogen pressure is approximately 485 pounds per square inch, which is sufficient to hold the howitzer in battery at all angles of elevation. Gages are provided to indicate both the quantity of liquid and nitrogen pressure. Suitable pumps are provided with the matériel for pumping in liquid and air. Cylinders of compressed nitrogen are carried to replenish the supply of nitrogen.

The cradle is secured in the trunnions of the carriage and supports the sleigh during recoil. To the underside of the cradle are fastened two elevating arcs; thus the howitzer is elevated by means of the handwheel located on the left side of the carriage, and elevations from 0° to $42^{\circ} 20'$ may be obtained.

The traverse of the carriage is obtained by the traversing mechanism causing the carriage to slide on the axle, the trail pivoting on the spade. The movement is 3° each side of the center, or a total of 105 mils. The movement is obtained by means of a traversing nut rigidly fastened to the axle, causing a traversing screw to travel carrying the carriage along the axle. The carriage travels along the axle on rollers mounted on Belleville springs. When the gun is fired, the springs are compressed and the carriage rests on the axle. A lock is provided for relieving the strain on the traversing and elevating mechanisms when traveling. Two traversing handwheels are provided, one on each side of the carriage.

The wheels are of wood, 1,350 millimeters (53 inches) in diameter and are fitted with solid rubber tires. The carriage is equipped with a pair of brakes acting directly on the rubber tires. An armor-plate shield for the protection of the personnel against small arms and shrapnel fire is also provided.

Sighting is accomplished by means of a quadrant sight, panoramic sight, and peep sight.

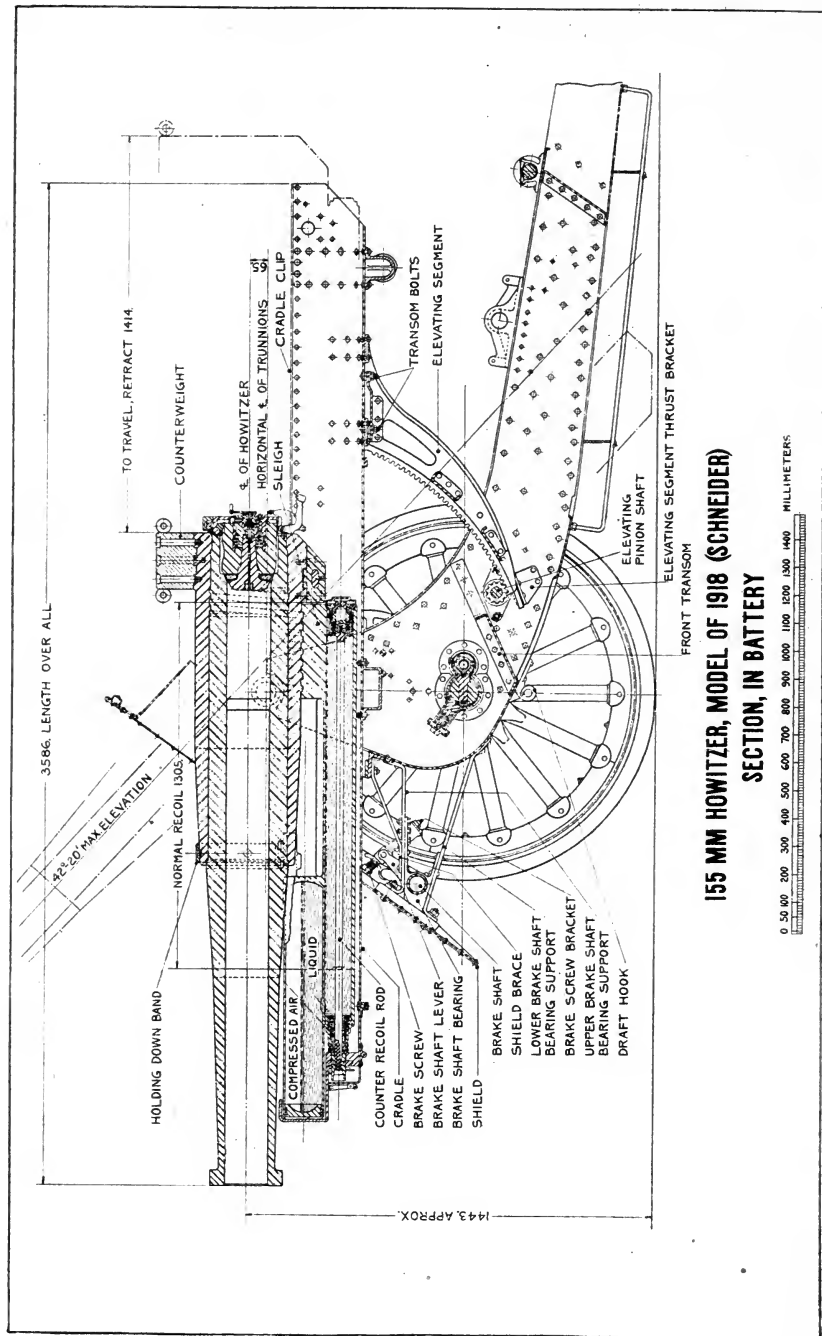

The quadrant sight, model of 1918 (Schneider), is mounted on the left trunnion of the carriage. It is used for laying the piece in elevation. The angle of site mechanism is combined with this sight. Mounted on the top of the quadrant sight is the United States panoramic sight for laying the piece in traverse. An extension bar is provided for use with the panoramic sight to enable the sight to be raised enough to see over the shield or other obstructions in direct aiming.

The peep sight, used only in direct fire, or in emergency, may be mounted on the quadrant sight in place of the panoramic sight.

Two complete sets of night-sighting equipment are provided for use when firing at night. When not in use these equipments are packed in cases provided for that purpose and carried on the carriage limber. The night lighting equipment consists principally of a chest, an aiming lamp, an azimuth lamp, a portable lamp, and the necessary cables and fixtures.

155-MILLIMETER HOWITZER CARRIAGE LIMBER, MODEL OF 1918 (SCHNEIDER).

The 155-millimeter howitzer carriage limber is a two-wheeled vehicle employed to support the trail of the carriage when traveling. This limber consists of a built-up steel frame mounted on wheels and axle. It has no chests and provides no seats for the personnel.

The pintle is riveted to the extreme rear end of the frame and serves as a bearing for the lunette of the carriage when the howitzer is limbered. Additional support for the trail is provided by a trail rest riveted in front of the pintle and on which the fifth wheel of the trail bears.

Hooks are provided for carrying a picket rope, and small boxes for carrying grease and the night lighting equipment are secured on the frame.

A prop is provided on the front of the frame for holding the limber up when not en route. The standard short pole with the lunette for motor traction batteries is provided, or the long pole may be substituted for horse-drawn equipment.

The wheels are of wood construction, 1,240 millimeters (48.82 inches) in diameter, with solid rubber tires.

Weight and principal dimensions.

Weight of limber empty.....	pounds..	1, 227
Weight of limber completely equipped.....	do....	1, 440
Weight of limber and carriage, limbered.....	do....	8, 930
Weight on ground under each wheel, with carriage limbered.....	do....	1, 380
Weight of each wheel.....	do....	335
Diameter of wheels.....	inches..	48. 82
Width of track.....	do....	61
Turning angle of limber and howitzer carriage, limbered.....	degrees..	52

NOTE.—The weight of this carriage limber equipped with horse pole is practically the same as with motor pole.

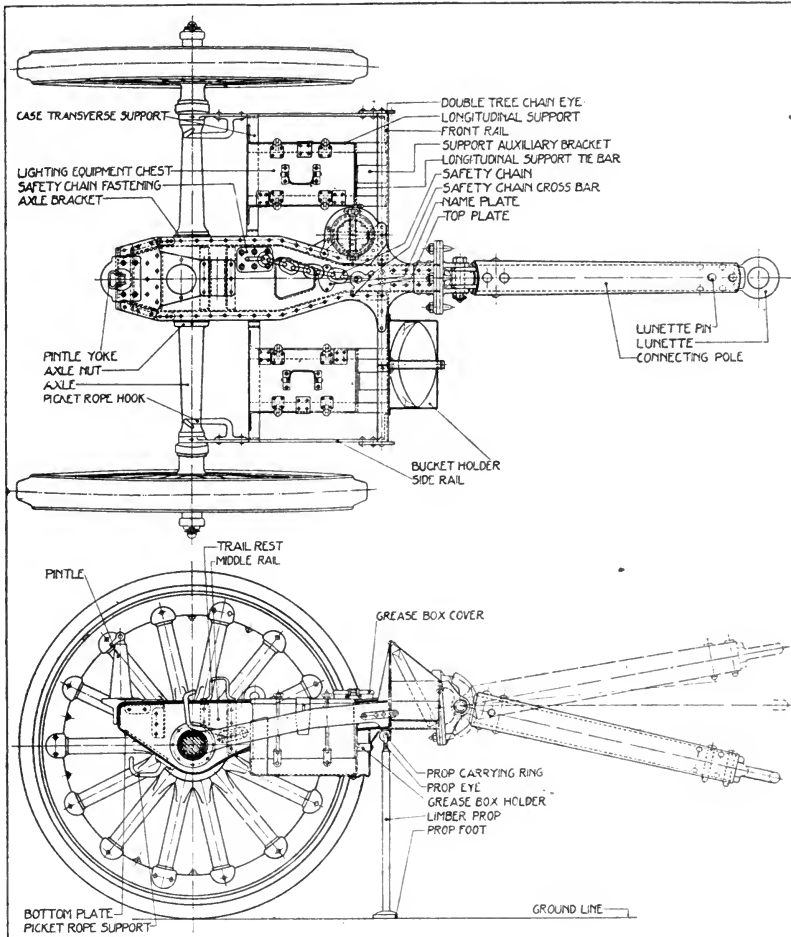

**155 MM. HOWITZER CARRIAGE LIMBER,
 MODEL OF 1918 (SCHNEIDER).
 PLAN AND RIGHT SIDE VIEWS**

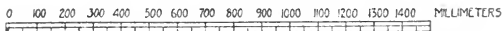

155-MILLIMETER HOWITZER CAISSON, MODEL OF 1918.

The 155-millimeter howitzer caisson is a two-wheeled spring supported vehicle for the transportation of ammunition. Normally it is a motorized vehicle, two caissons forming a train drawn by one tractor. However, by removing the connecting pole and substituting the standard pole the front vehicle of the train can be converted into a horse-drawn caisson limber. Any caisson in the battery

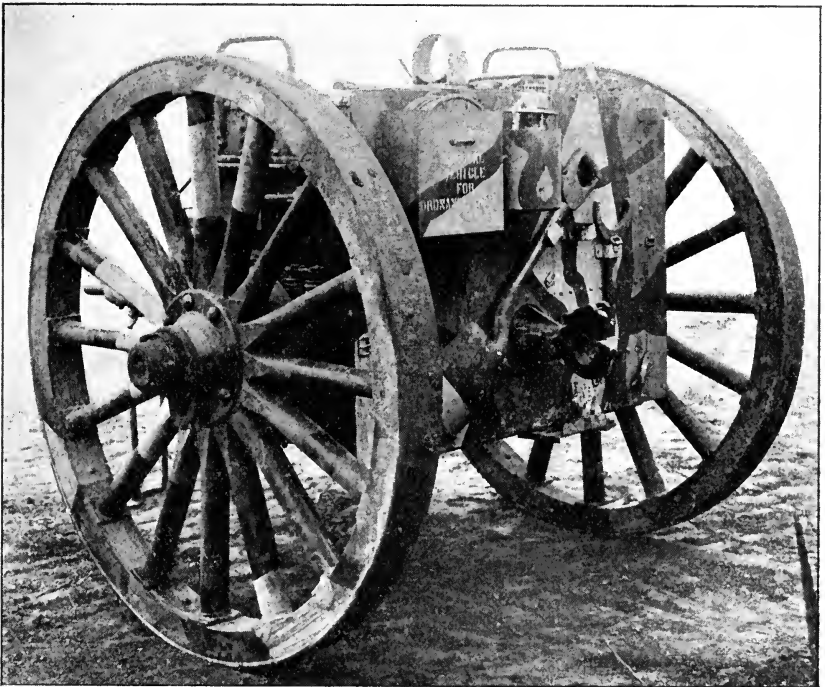

REAR VIEW OF CAISSON.

except the caisson equipped with the hand reel can be so converted into a caisson limber. The caisson carries 14 complete rounds of ammunition and 2 extra powder charges for the 155-millimeter howitzer.

The chest is made up of the lower and upper chest body and rear plate, which is of armor plate. The chest is divided into an upper and lower compartment, the opening between them forming a space for the axle, pole socket, pintle bracket, and houses the fuze box and oil can.

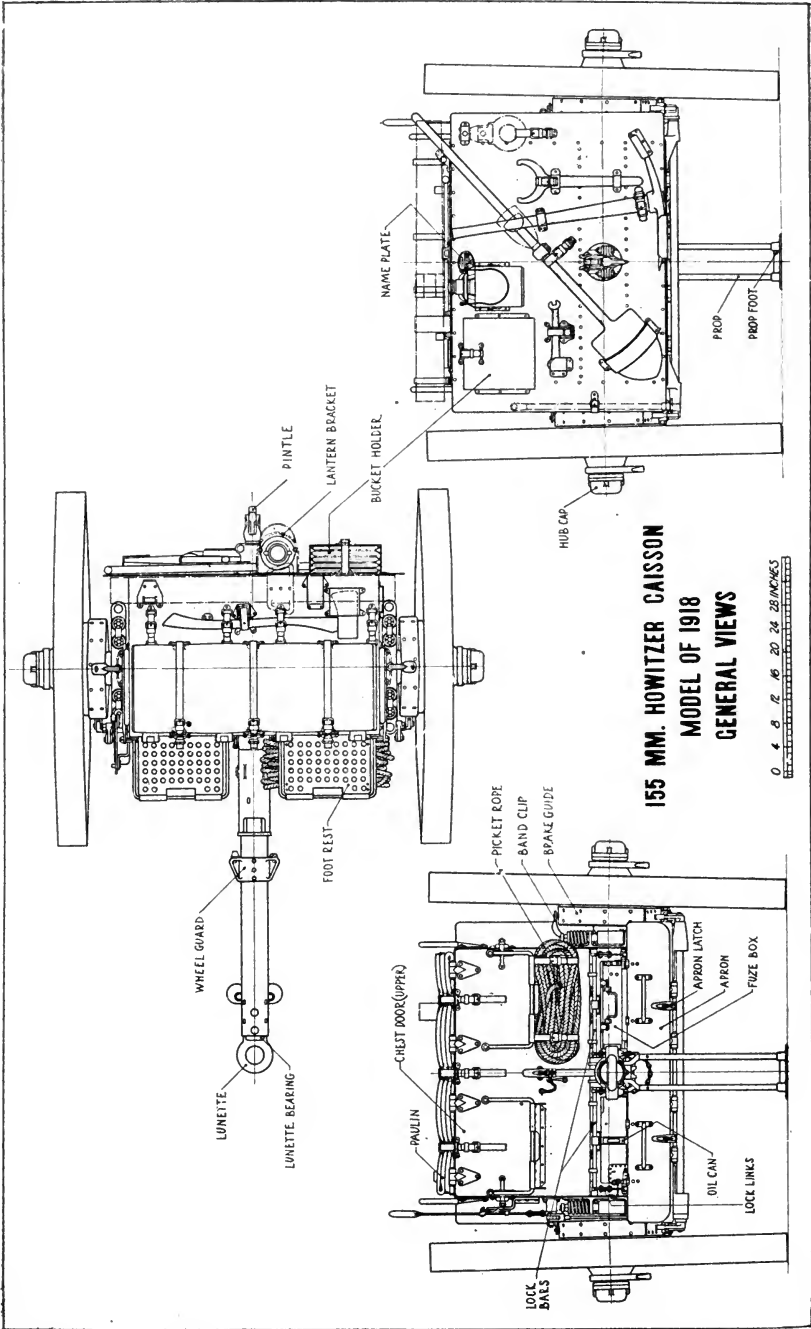

155 MM. HOWITZER CAISSON
MODEL OF 1918
GENERAL VIEWS

0 4 8 12 16 20 24 28 32 36 40 44 48 52 56 60 64 68 72 76 80 84 88 92 96 100

The upper compartment is arranged for the transportation of 8 projectiles and 16 powder charges. Powder is served to the caissons in fiber containers, each containing 2 powder charges. The container is fitted with an air-tight joint metal cover and base. The lower compartment is arranged for the transportation of 6 projectiles. The upper chest door when closed forms a cover for the chest and is held open by door props. When open, this armor plate door serves as a shield for the cannoneers.

The lower compartment is also provided with an armor plate door hinged to the bottom of the chest body, and has an armor plate apron hinged to its edge. When open, the lower chest door and apron hang down, forming a shield for the cannoneers. When closed, this door forms a cover for the lower compartment; the apron doubles back against the lower chest door and is latched in place.

Both compartments are provided with loose diaphragms, by the use of which the caisson can be made available for transporting any of the following types of shells:

- 155-millimeter common steel shell, Mark I;
- 155-millimeter common steel shell, Mark II;
- 155-millimeter shrapnel, Mark I;
- 155-millimeter common steel shell, Mark IV;
- Semisteel shell, Mark XVII.

Only one type of shell can be carried in the same compartment at one time. When carrying either common steel, gas, or shrapnel, the loose diaphragms are placed in position after the projectiles are inserted in the projectile tubes. When the doors are closed (carrying either common steel or gas shells) the door stiffeners bear against the bases of the projectiles, holding them in place. With shrapnel the edges of the flanged holes in the loose diaphragm bear against the rotating bands of the projectiles. When used to transport common steel shells Mark IV the loose diaphragms are placed inside the body of the caisson next to the front diaphragms. When the doors are closed the door stiffeners bear against the bases of the projectiles, holding them firmly against the loose diaphragms.

Foot rests, handrails, and grip straps are provided on the chest for the convenience of its personnel. The outside of the chest is provided with implement fastenings for the usual complement of accompanying tools and accessories. Blanket straps are provided on top of the chest for carrying the blanket rolls of the battery personnel; provision also is made on top of the chest for carrying the connecting pole and on the rear for carrying the lunette and caisson prop when used as a horse-drawn vehicle.

The caisson prop when down serves to support the front end of the caisson; in traveling it is swung up and held by the prop chain.

The axle passes through the caisson between the upper and lower intermediate plates. Axle brackets are clamped on either end of the axle just outside of the chest, and rotation or lateral motion of the

chest is prevented by clamp screws and Belleville springs. The chest has a spring suspension similar to that of the 4.7-inch gun caisson, model of 1917, for the relief of road shocks.

The caisson is provided with a brake mechanism of the band type. The brake drums are mounted on the hub boxes of the wheels and the band brakes lined with Raybestos. A brake lever secured to a bracket riveted to the caisson body, functions as a means by which the brakes may be applied.

The caisson is usually equipped with the short pole for motor traction, but the pole socket is designed so that the long pole may be used when desired to use the vehicle as a horse-drawn limber. A

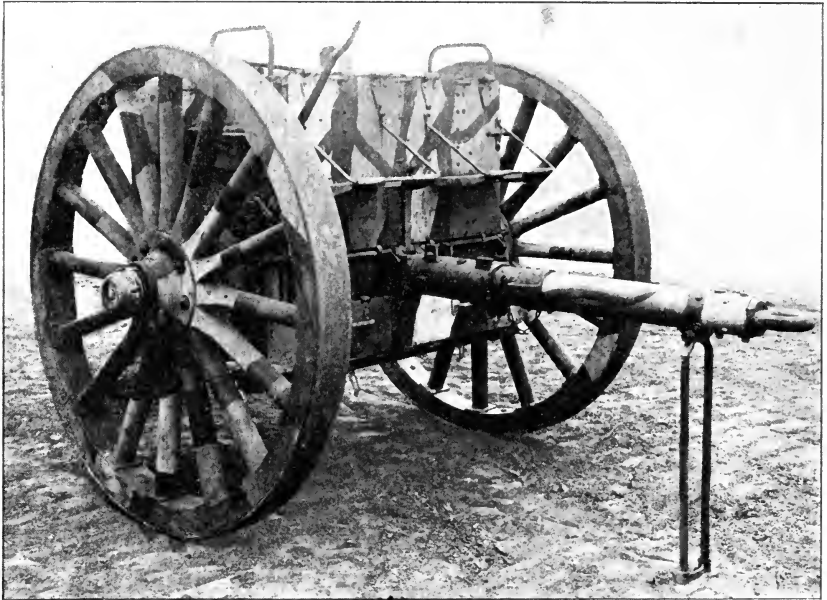

FRONT VIEW OF CAISSON.

standard pintle is fitted at the rear for the connection of the other vehicles.

One caisson in each battery is equipped with a reel for caisson, model of 1917. This is a hand-operated reel for the transportation and handling of telephone wire. See page 159.

Weights and dimensions.

Overall length.....	inches..	79
Overall width.....	do....	78.5
Overall height.....	do....	67
Weight without equipment (unloaded).....	pounds..	2,345
Weight fully equipped (unloaded).....	do....	2,447
Weight completely equipped and loaded.....	do....	3,949
Weight of reel caisson completely equipped and loaded.....	do....	4,006
Width of track.....	inches..	60
Diameter of wheels.....	do....	60
Turning diameter of two caissons.....	feet..	18

155-MILLIMETER GUN MATÉRIEL, MODEL OF 1918 (FILLOUX.)

The type of 155-millimeter field gun adopted is known by the French as the "G. P. F." (Grande Puissance Filloux); and by the United States as the model of 1918. This caliber, which corresponds to 6-inch artillery, is the heaviest mobile artillery, exclusive of the heavy howitzers and the railroad artillery.

This monster weapon is of rugged design, combining mobility and power, and has a large horizontal training angle to render it suitable for the concentration of artillery fire for the destruction of strongly fortified points, such as armored batteries, etc.; thus no other available weapon of equivalent caliber can be considered to rival this type. This piece, like the 155-millimeter howitzer, is especially valuable in

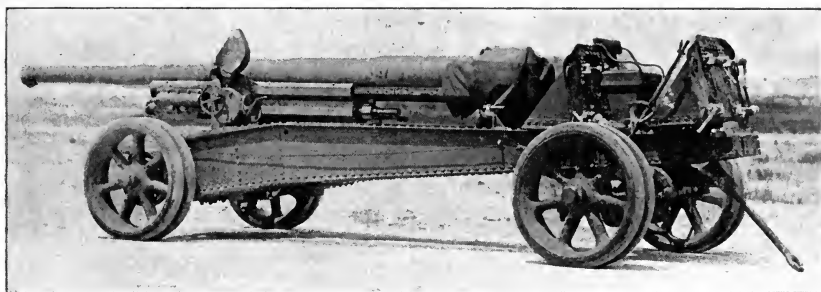

TRAVELING POSITION (RIGHT SIDE).

firing against captive balloons, counter battery firing, and interdiction.

The Filloux gun is mounted on a carriage having a split trail of box girder section; which is spread out when in action, the ends of the trail being firmly anchored by spades in the ground. The split-trail effect permits clearance for recoil at high elevations and allows a firing over a horizontal field of 60° and an elevation varying from 0° to 35° .

Its muzzle velocity is about 2,411 feet per second, a rate of propulsion that throws its projectile weighing 95 pounds, approximately 17,700 yards, or a little more than 10 miles.

The gun recoils in slides formed in the cradle which rests in the trunnions of the top carriage. The length of recoil is automatically controlled and varies with the elevation, while the counter recoil is pneumatic. The entire recoil mechanism is commonly called the recuperator and is supported on the carriage at its trunnions. When

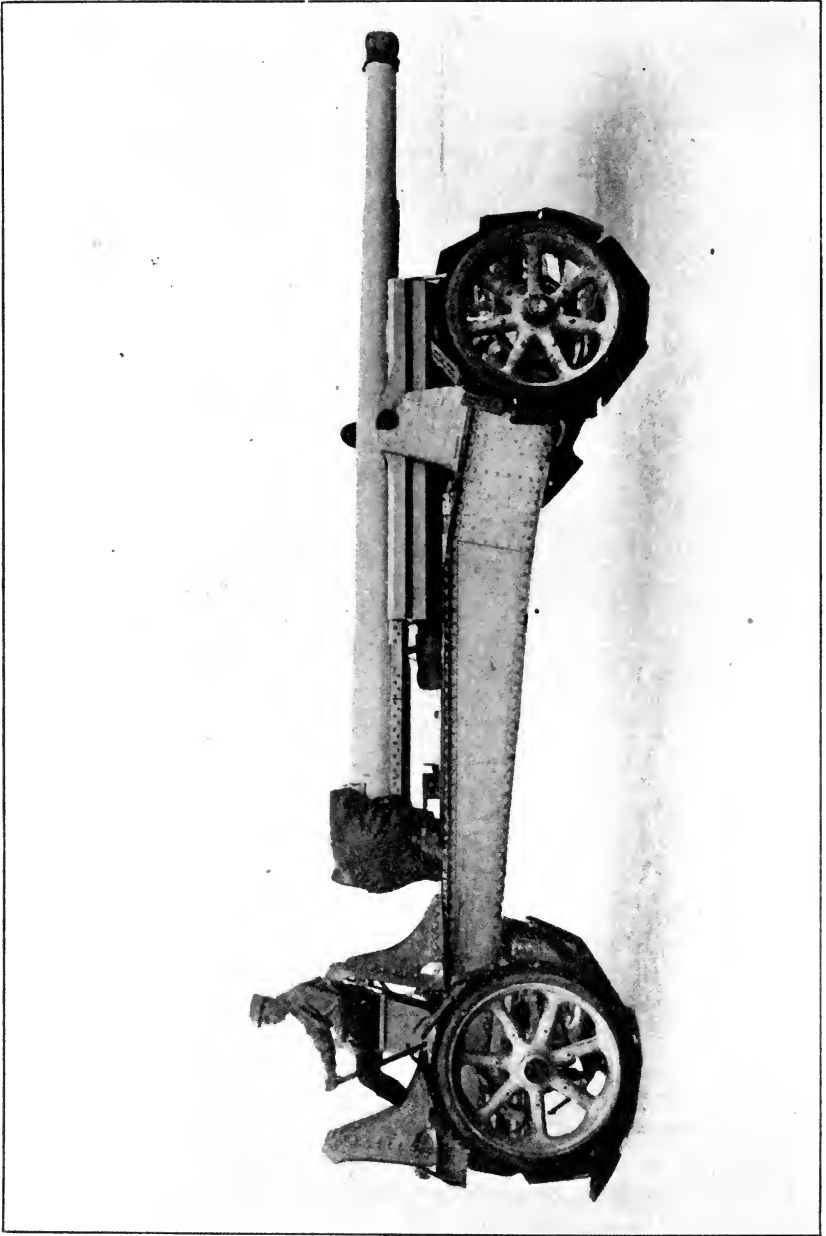

155-MILLIMETER GUN CARRIAGE AND LIMBER, TRAVELING POSITION.

traveling, the trail is closed up and the ends thereof are supported by a carriage limber provided with a steering gear brake, and is drawn by a tractor. In traveling position both carriage and carriage limber are supported on semielliptical springs to absorb all road shocks and vibrations.

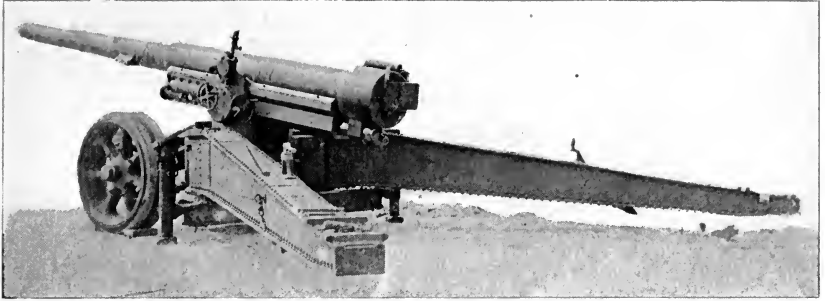

REAR VIEW OF CARRIAGE IN BATTERY POSITION.

The life of the gun before relining becomes necessary is about 3,000 rounds and maximum rate of fire is two rounds per minute. The entire equipment is motorized. A carriage limber, which supports the trails in traveling, accompanied each gun. Caissons are not used with these guns, the ammunition being carried in motor trucks or cargo carriers.

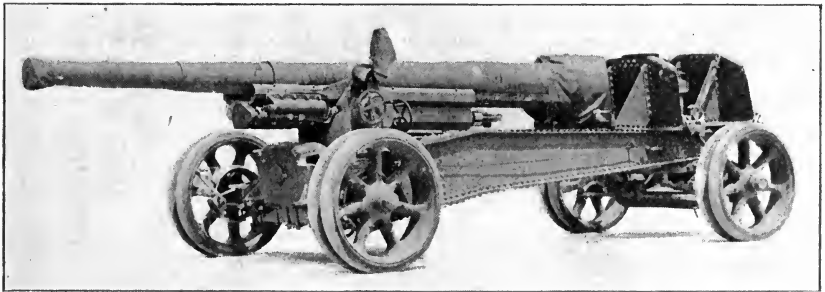

CARRIAGE IN TRAVELING POSITION (REAR VIEW).

155-millimeter gun matériel, model of 1918 (Filloux) consists of:

155-millimeter gun and carriage, model of 1918.

155-millimeter gun carriage limber, model of 1918.

The above matériel is of French design and of both French and American manufacture.

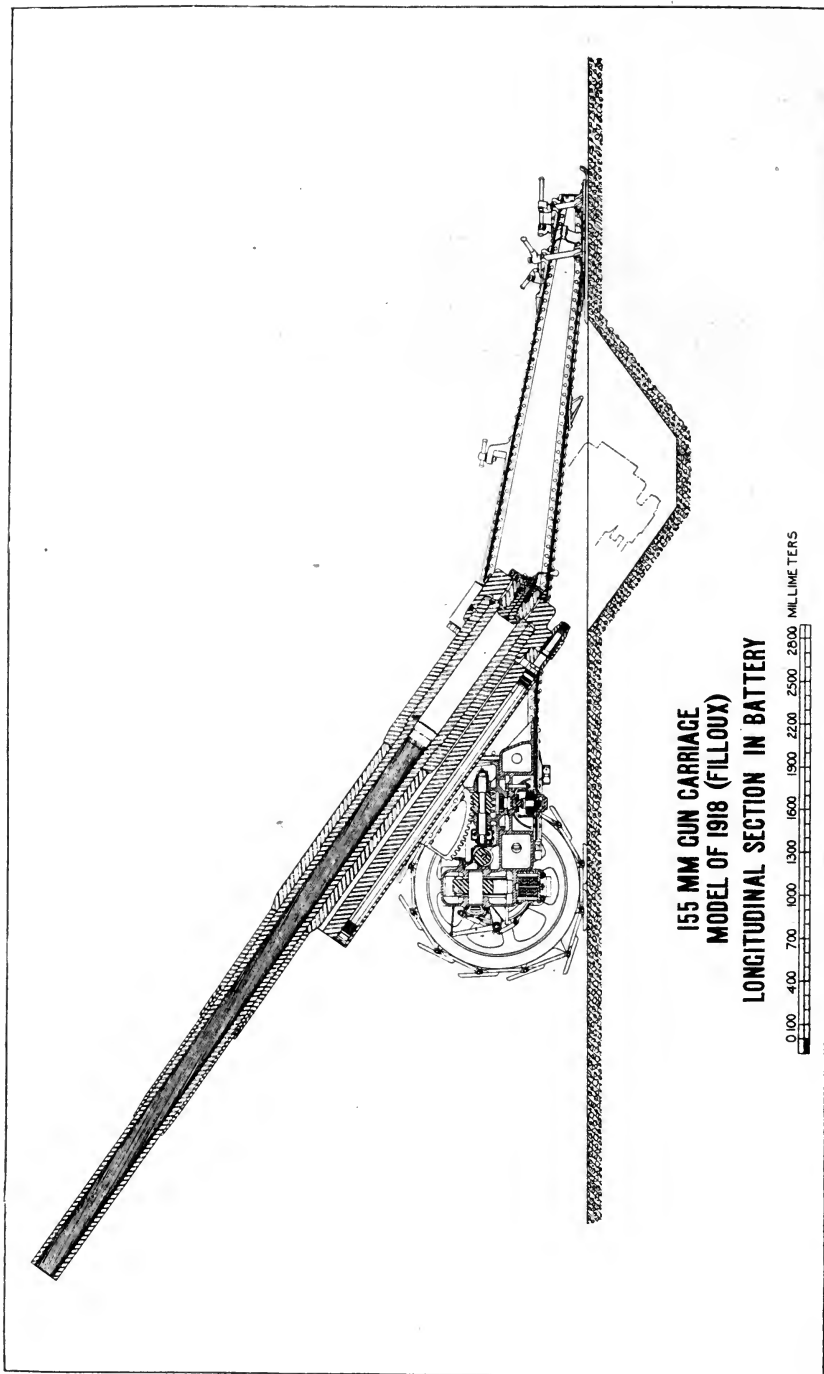

Weights, dimensions, ballistics, etc.

Weight of gun, including breech mechanism.....	pounds..	8,795
Length of gun.....	inches..	232.87
Caliber.....	do....	6.1042
Muzzle velocity.....	feet per second..	2,411
Rifling: one turn in 2.989 caliber right hand uniform.		
Weight of projectile.....	pounds..	95
Maximum range (Mark III shell at 35° elevation).....	yards..	17,700
Weight of maximum powder charge.....	pounds..	25¼
Weight of carriage only.....	do....	11,065
Weight of gun and carriage complete.....	do....	19,860
Diameter of wheels.....	millimeters..	1,160
Width of track.....	do....	2,250
Height of axis of gun from ground.....	do....	1,482
Range of elevation.....	degrees..	0 to 35
Maximum traverse.....	do....	60
Weight of gun carriage and limber.....	pounds..	23,050
Weight of limber complete.....	do....	3,190
The distance from center line of carriage axle to center line of limber axle, approximately.....		
	millimeters..	4,500

155-MILLIMETER GUN AND CARRIAGE, MODEL OF 1918 (FILLOUX).

The gun, models of 1918 and 1918 M1 is of the built-up type, consisting of a tube strengthened by a ring, jackets, hoops, and the muzzle bell. All details except the firing mechanism provide interchangeability of parts with the 155-millimeter (G. P. F.) guns of French manufacture. A recoil lug on the under side of the breech ring provides means of attaching the recoil and recuperator rods. Bronze clips to serve as guides in the cradle are secured to the sides of the jackets.

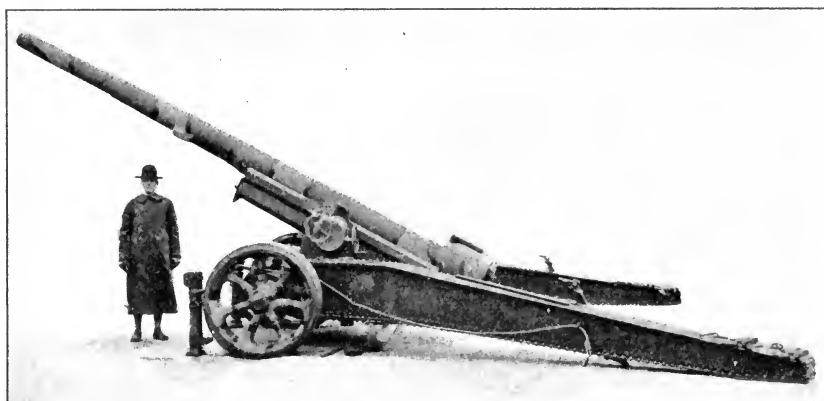

MAXIMUM ELEVATION OF GUN.

The breech block is of the interrupted-screw type, having four plain and four threaded sectors. The breech mechanism is of the plastic obturator type, having the forward mushroom-shaped head of the breech block equipped with an asbestos ring known as the obturator pad. Upon firing, this ring is compressed and acts as a gas check to prevent the leakage of powder gases through the breech. It has sufficient resiliency to resume its original form after firing. The firing mechanism is of the French-percussion primer type described under "155-millimeter Schneider howitzer," page 216, and is interchangeable with the guns enumerated therein.

The cradle is a steel forging bored with three parallel cylinders for housing the recoil brake and recuperator, and is pivoted by trunnions in the trunnion bearings of the top carriage. On the upper side of the cradle are slots for the gun slides, and to its lower side the elevating rack is bolted.

BREECH MECHANISM

**155 M.M. GUN
MODEL OF 1918.
(FILLOUX)**

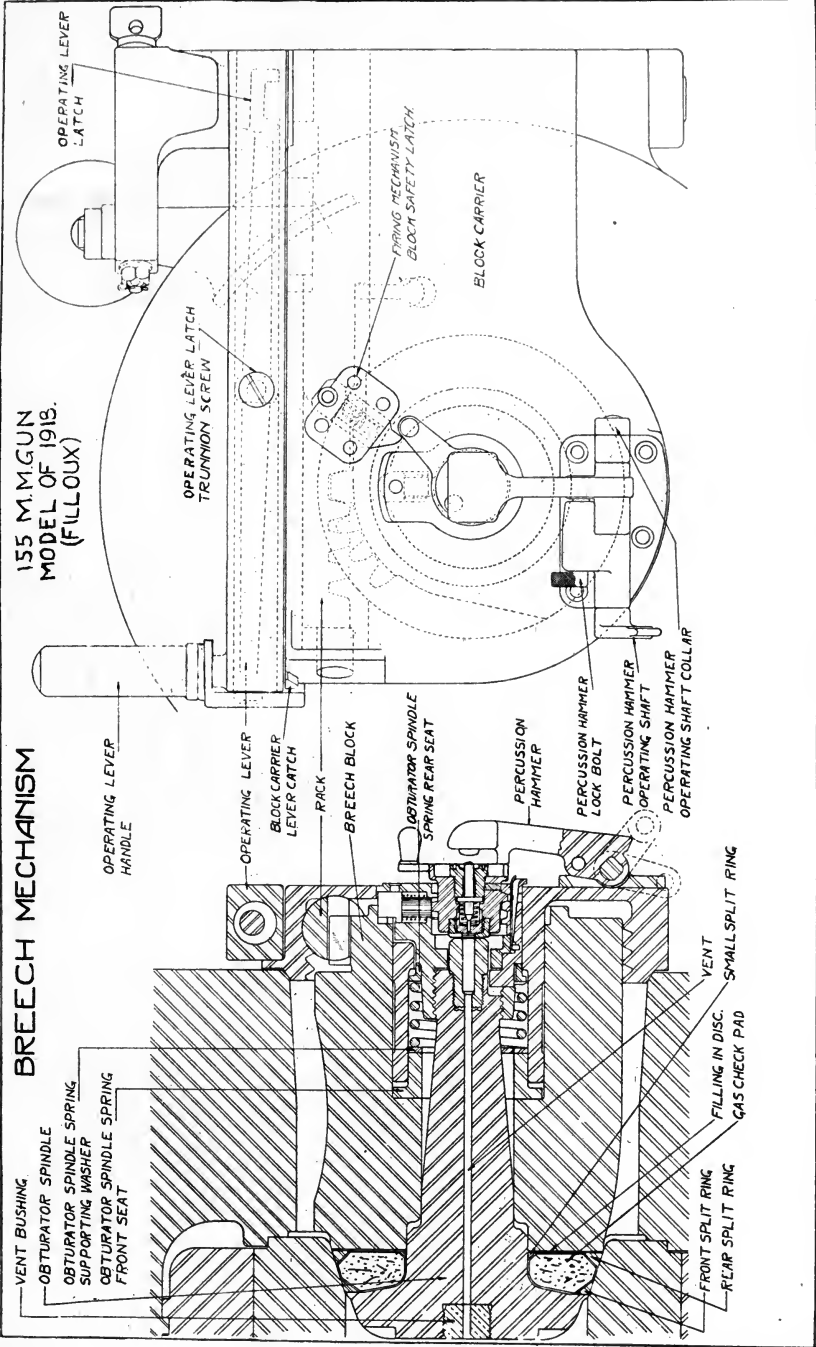

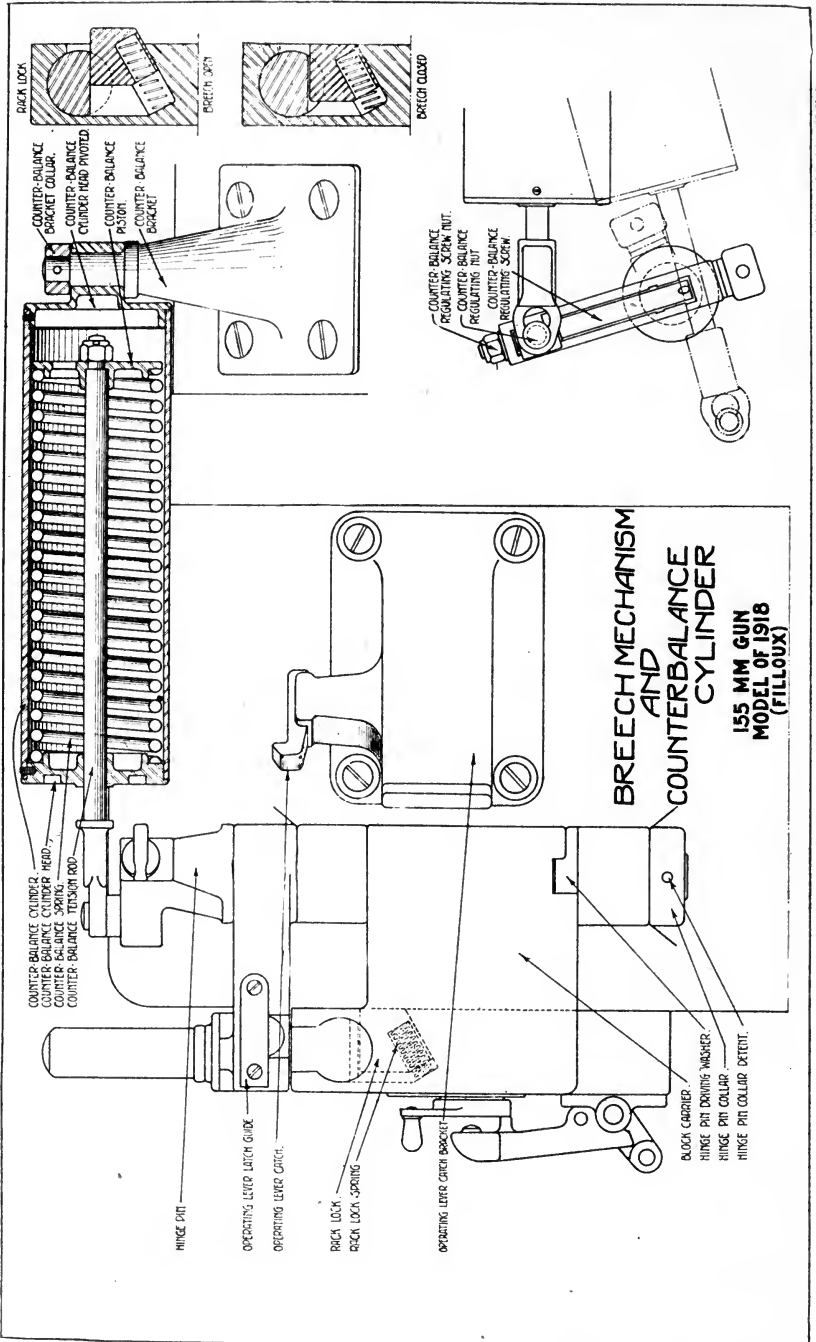

The *recoil mechanism* is of the hydropneumatic variable recoil type. The larger of the three cylindrical bores in the cradle block contains the recoil mechanism; the two smaller ones, the parts of the recuperator mechanism.

This mechanism consists of a piston and piston rod and a control rod. The piston rod is connected to the breech lug and, therefore, recoils with the gun. Grooves of variable depth are milled along the length of the control rod, controlling the flow of oil through the ports of the piston during recoil. The control rod assembles within the bore of the piston rod, and does not move longitudinally, but rotates. The amount of this rotating changes the area of the orifices through which the oil can pass. Its rotation is accomplished as the gun is elevated by means of an arm and gear sectors in such a manner as to shorten the recoil as the gun elevates.



CARRIAGE IN FIRING POSITION.

A replenisher or gravity tank is provided in connection with the recoil cylinder which assures the recoil cylinders being full at all times and also takes care of any expansion of the oil due to heating. Its capacity is about 17 quarts.

The *recuperator mechanism* consists of two connected cylinders, one containing the piston and piston rod which are attached to the breech lug, while the other contains a mushroom valve and a diaphragm. The diaphragm separates the oil contained in the first cylinder and part of the second cylinder from the high-pressure air, which compels the return of the gun into battery after recoil. Normally a small amount of oil must be between the valve and diaphragm. Oleonapthe is the liquid used in this recoil mechanism. The amount of oil in the recoil and recuperator mechanism is shown by indicators so that it can always be seen whether or not they need filling.

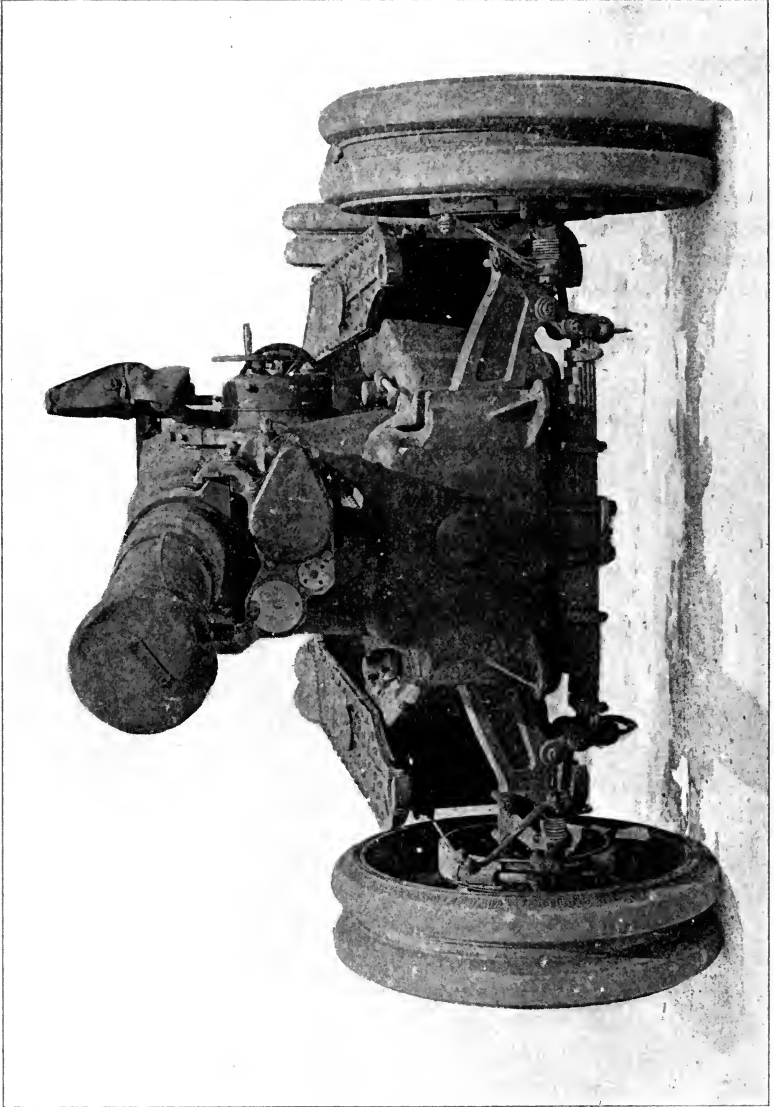

REAR VIEW OF 155-MILLIMETER GUN CARRIAGE, MODEL 1918, IN TRAVELING POSITION.

The top carriage is a steel casting mounted on the bottom carriage, on which it pivots to traverse the piece. Belleville springs carry the weight of the gun when traversing, but on firing the springs compress and the firing stresses are taken on the bearing surfaces between the top and bottom carriages.

The tipping parts are carried on the trunnions of the top carriage, which also houses the elevating and traversing mechanism and permits high angle of elevation for the cradle.

The bottom carriage is a steel casting suspended from the axle (in traveling position) by a heavy multiple leaf spring. It supports the top carriage, houses the axle, and provides hinge connections for the trail. When firing the axle is unshackled from the springs and the bottom carriage bears directly on the axle.

Traversing is accomplished by rotation of the top carriage on the bearing surface of the bottom carriage by means of a rack and train

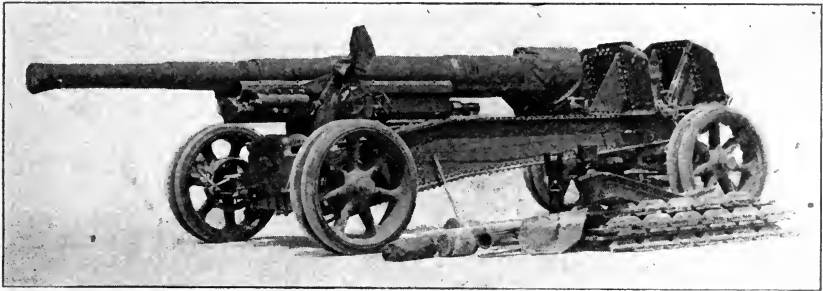

ACCESSORIES AND CATERPILLAR WHEEL SHOES.

of gears which are operated by the handwheel on the left side of the carriage. A traverse of 60° — 30° right and 30° left—is possible.

Elevating is accomplished by a rack on the cradle operated through gears by the handwheel located on the gear box at the left of the top carriage. Elevations from 0° to 35° are obtainable.

The trail is of the split type and consists of steel plate beams of box section. Locks are pivoted at the forward end of the trails for securing them in the open position. When closed together they are clamped and attached to the limber. A traveling lock is provided on the trail for retaining the gun in retracted position. Two types of spade are provided, one for soft and one for hard ground. When traveling the spades are always removed from the trail.

The wheels are of cast steel, each wheel having two solid rubber tires and are equipped with the usual band brakes. Caterpillar wheel shoes for traveling over soft ground are provided, which assemble over the rubber tires. They consist of 12 plates for each wheel, which give a broad bearing surface under the wheel.

**155 MM GUN CARRIAGE
MODEL OF 1918 (FILLOUX)
TOP CARRIAGE, LEFT SIDE
VIEW SHOWING ELEVATING
AND TRAVERSING MECHANISM**

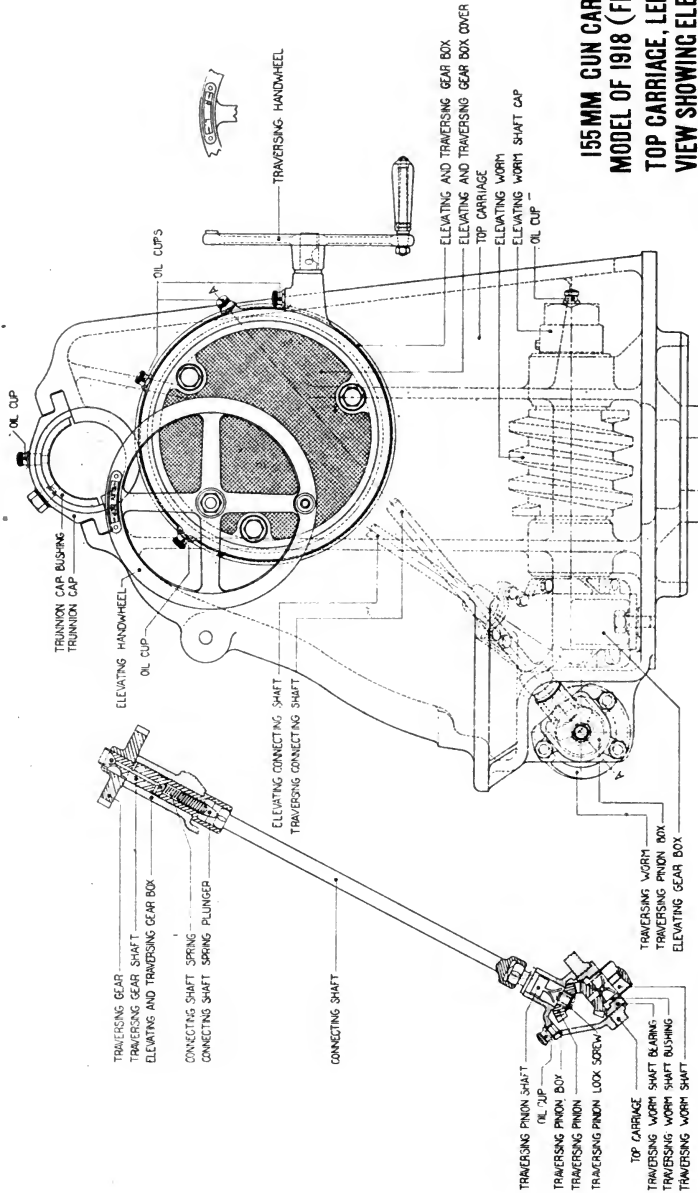

SECTION A-A

0 20 40 60 80 100 120 140 160 180 200 220 240 260 280 300 320 340 360 380 400 420 440 460 480 500 MILLIMETERS

The sighting equipment is exactly the same as that described under the 155-millimeter Schneider howitzer, except the difference in bracket as indicated on page 219.

Ammunition used is of the separate loading type; the projectile weighs 95 pounds and the charge 25 pounds. Either shrapnel or high-explosive steel shell is used, as well as gas shells and other special ammunition. The propelling charge of smokeless powder is a sectionalized charge made up of two sections—a base charge and one smaller increment.

The fuses commonly used are the 31-second combination fuze for use with shrapnel and combining time and percussion elements—the point detonating fuze Mark IV used with the steel high explosive shell, and the Mark II point detonating fuze used with gas shell.

155-MILLIMETER GUN CARRIAGE LIMBER, MODEL OF 1918 (FILLOUX).

The carriage limber is a two-wheeled vehicle designed to support and secure the rear ends of the trails and to provide a coupling attachment to the tractor when transporting the carriage. The principal parts are the wheels, axle, steering mechanism, frame, springs, and seat.

The axle is very similar to the usual design of front axles of automobiles. It is of I-beam section, having forked ends with axle arms pivoted therein, providing a means of steering. By means of a drag link and steering lever pivoted at the center of the frame and connected to the steel pole steering is accomplished.

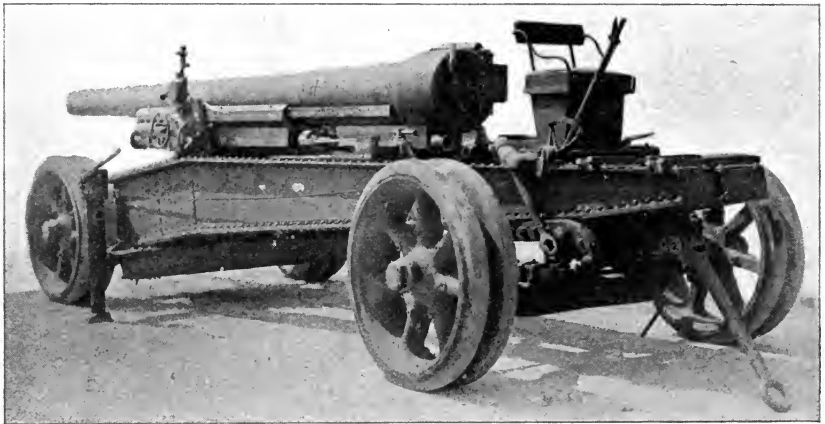

FRONT VIEW OF LIMBER EN ROUTE.

The frame or clamp for holding the gun trail in position is mounted on the axle by means of two semielliptical multiple leaf springs. The upper cross beam of this frame has bolted to it a seat for the brakeman, who operates the gun-carriage brake when en route by means of a lever acting through a wire rope. The wheels are identical with and interchangeable with the wheels of the gun carriage.

Weights and dimensions.

Weight complete.....	pounds..	3, 190
Weight with carriage and gun.....	do....	23, 050
Weight of carriage on limber (traveling position).....	do....	6, 490
Width of track (center to center of tires).....	millimeters..	2, 250
Free height under limber and carriage (traveling position).....	do....	250
Diameter of wheels.....	do....	1, 160
Height of seat cushion from ground (seat assembled on top of trails, traveling position).....	millimeters..	1, 550
Distance from center line of carriage axle to center line of limber axle (trails on limber).....	millimeters..	4, 500

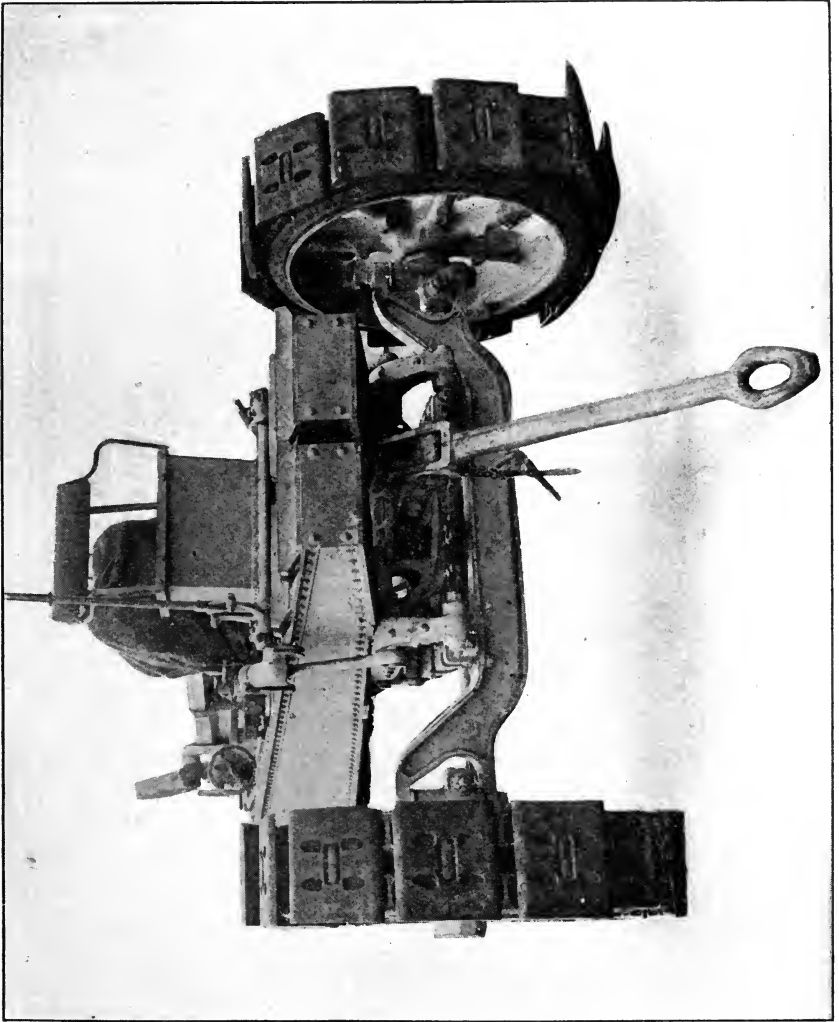

155-MILLIMETER GUN CARRIAGE LIMBER, WITH CATERPILLAR SHOES ATTACHED.

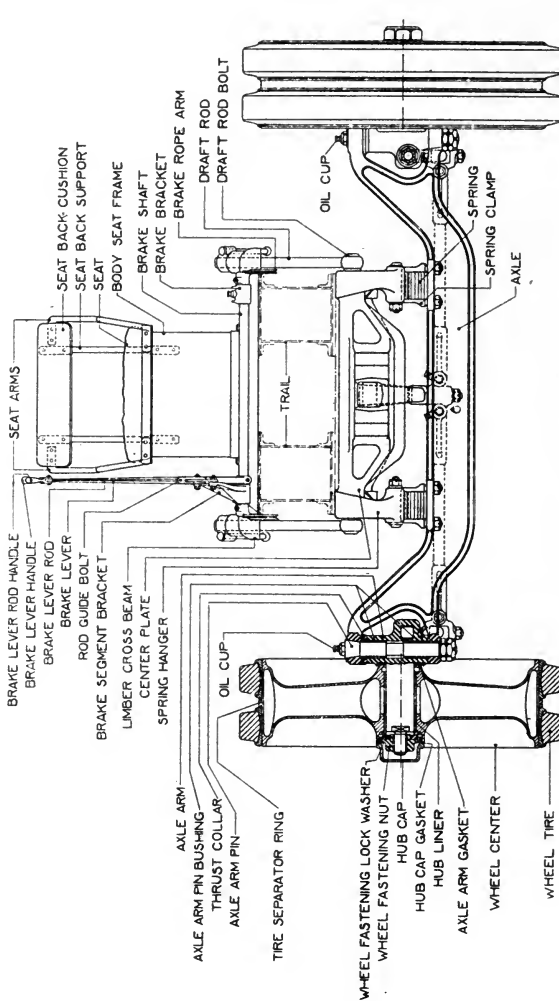

**155 MM GUN CARRIAGE LIMBER
 MODEL OF 1918 (FILLOUX)
 FRONT VIEW**

0 50 100 200 300 400 500 600 700 800 900 1000 1100 1200 1300 1400 MILLIMETERS

6-INCH GUN MATÉRIEL, MODEL OF 1917 (BRITISH).

The 6-inch gun matériel, model of 1917, is British throughout, being designed and manufactured in England. It consists of a 6-inch gun, Mark XIX, mounted on an 8-inch howitzer carriage, Mark VII, known as the 6-inch gun carriage, Mark VIIIA. This Mark XIX gun is of wire-wound construction, having a muzzle velocity of 2,350-feet per second and a range of 17,500 yards.

The gun body is of steel and consists of tubes, a series of layers of steel wire, jacket, breech bush and breech ring. The breech ring is prepared for the reception of the breech mechanism and is provided with a lug on the under side for the attachment of the hydraulic buffer and recuperator of the carriage.

The breech mechanism is operated by means of a lever on the right side of the breech. On pulling the lever to the rear the breech screw is automatically unlocked and swung into the loading position. After loading, one thrust of this lever inserts the breech screw and turns it into the locked position. The breech mechanism is similar to that used on the 8-inch howitzers both in design and operation.

The firing mechanism is of the percussion type and is not interchangeable with other British guns. The firing mechanism is designed for percussion firing, and is so arranged that the gun can not be fired until the breech screw is locked and the breech mechanism lever home.

The only changes necessary on the 8-inch howitzer carriages (p. 268) for mounting this 6-inch gun are: The rear extension plug, which connects the gun to the recoil mechanism, is modified and the cut-off gear is set differently to shorten the recoil when in action. The firing platform and all of the accompanying vehicles of the 8-inch howitzer matériel are used.

Ammunition of the separate loading type is used, both shrapnel and shell being issued.

Weights, dimensions, and ballistics.

Matériel of gun, steel wire wound.		
Length of gun.....	inches..	219
Weight of gun with breech mechanism.....	pounds..	10, 248
Weight of gun without breech mechanism.....	do....	9, 940
Rifling, uniform one turn in 30 calibers.		
Weight of shell or shrapnel.....	do....	100
Weight of powder charge (maximum).....	do....	23
Weight of powder charge (reduced).....	15 pounds 7½ ounces	

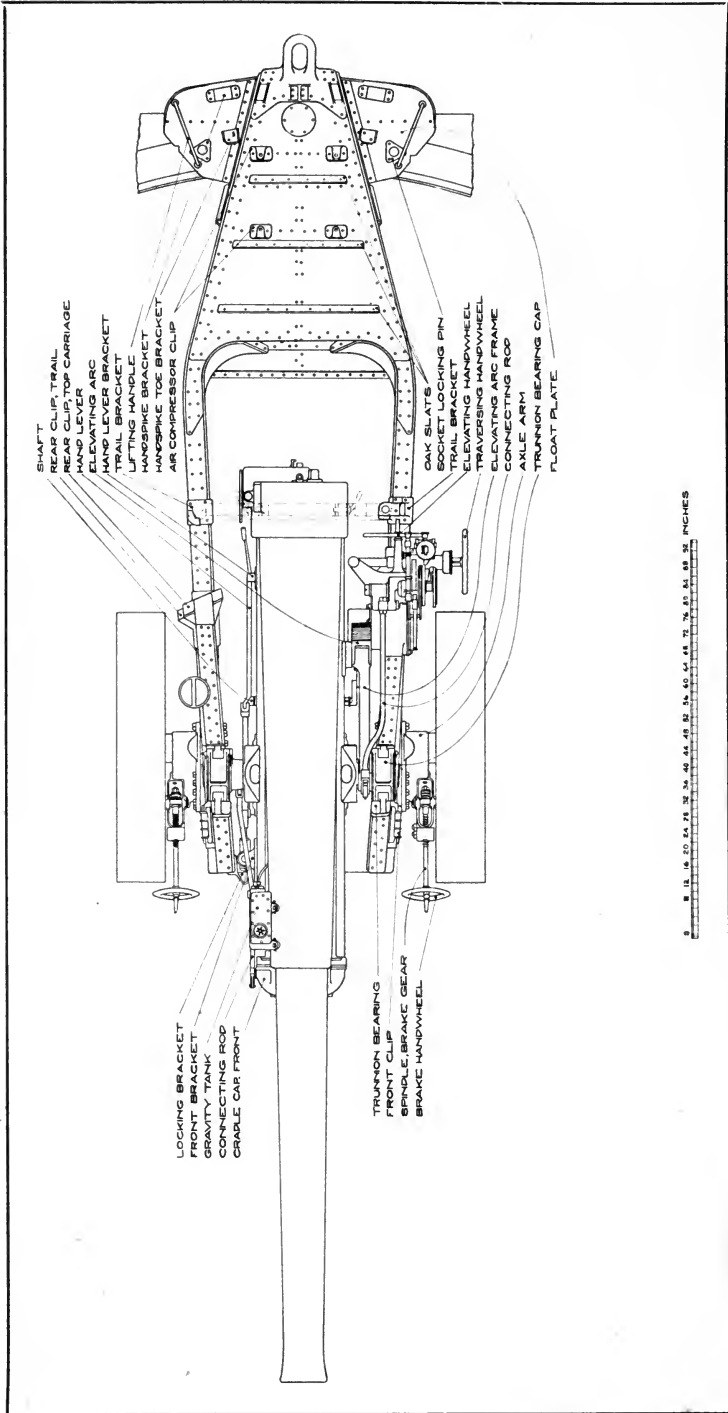

6-INCH GUN CARRIAGE, MODEL OF 1917 (BRITISH) (PLAN VIEW).

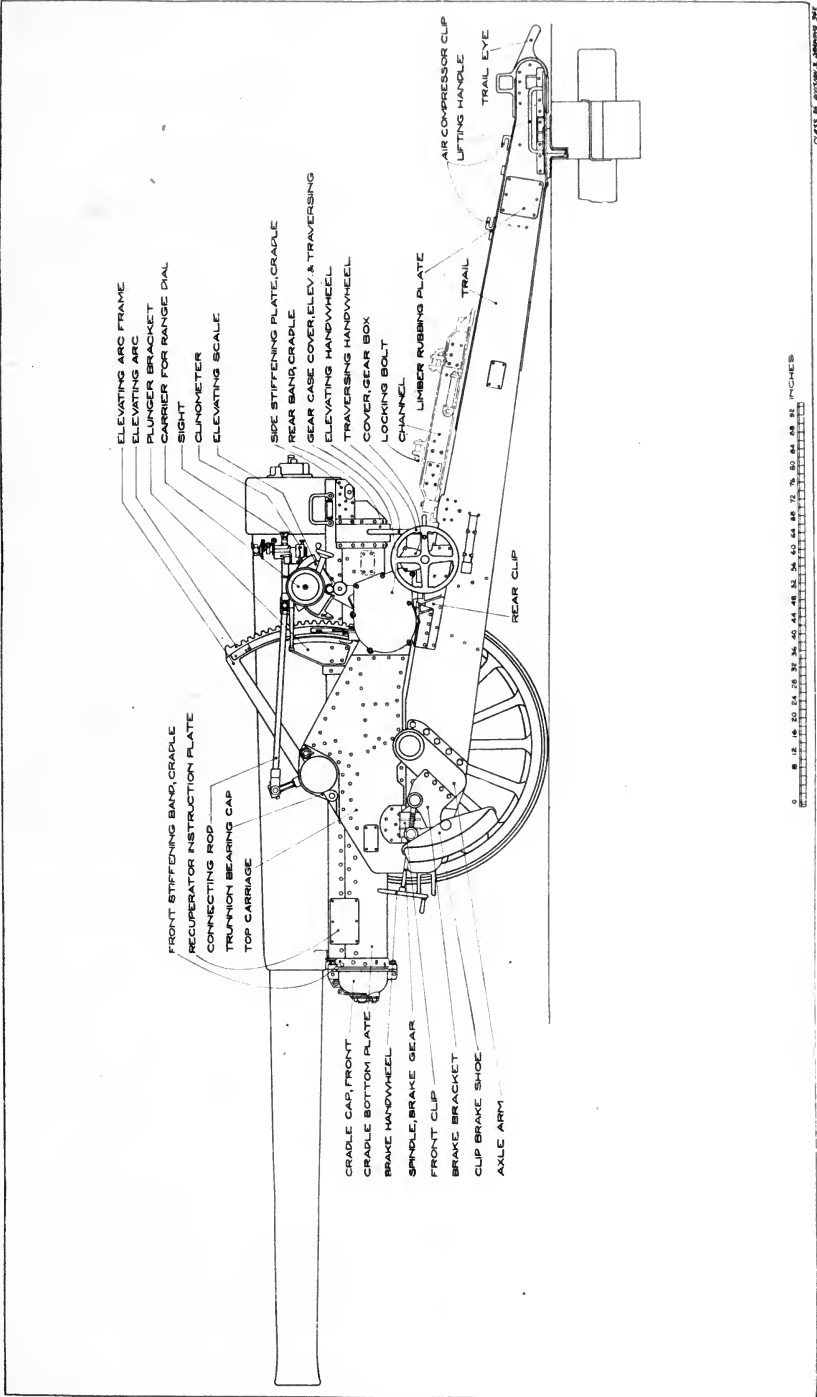

6-INCH GUN CARRIAGE, MODEL OF 1917 (BRITISH) (LEFT SIDE ELEVATION).

CGO 32, 400000-1, 200000 247

Maximum range:	
Full charge.....	yards.. 17, 570
Reduced charge.....	do.... 16, 100
Muzzle velocity:	
Full charge.....	feet per second.. 2, 350
Reduced charge.....	do.... 2, 000
Maximum elevation.....	degrees.. 38
Weight of carriage (only).....	pounds.. 12, 548
Weight of gun and carriage (fully equipped).....	do.... 22, 796

7-INCH NAVAL TRACTOR MOUNT, MARK V.

The 7-inch naval tractor mount, Mark V, is a mobile, track-laying field piece bearing a 7-inch, 45-caliber naval rifle. Projectiles weighing 153 pounds may be fired at angle of elevation varying from horizontal to 40°, and at the maximum elevation the extreme range obtainable is 24,000 yards.

The chamber diameter of the gun is 8.5 and the distance from the face of the tube to the base of the projectile is 54.39 inches. The volume of the powder chamber is 3,369 cubic inches. The maximum charge consists of 60 pounds of smokeless nitrocellulose powder, which produces the maximum service pressure of 17 tons per square inch. Under these conditions a muzzle energy of 8,315 foot-tons is

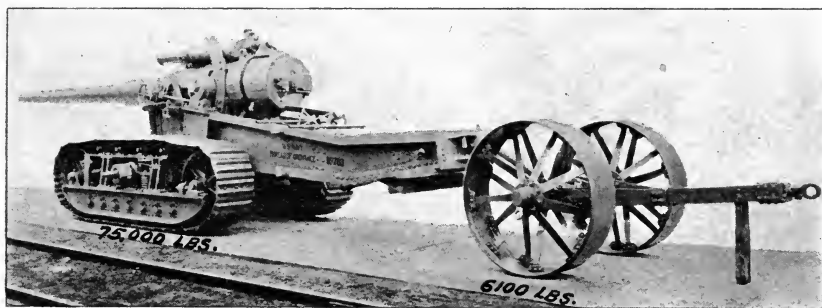

CARRIAGE AND LIMBER IN TRAVELING POSITION (FRONT VIEW).

imparted to the 153-pound projectile, the muzzle velocity being 2,800 feet per second.

The recoil mechanism is of the hydraulic type; the gun being returned to battery by a pneumatic counterrecoil system. The recoil system consists of a simple hydraulic brake, the energy of recoil is absorbed through a distance of 32 inches by forcing a mixture of glycerine and water through orifices of gradually decreasing diameter cut in the head of a piston operating in the recoil cylinder.

The method of reducing the size of the orifices is interesting. The recoil piston has holes bored through it to allow the liquid to pass from one side to the other when the piston starts to move back when the gun is fired. Tapered throttling rods enter the holes in the piston head, and as the piston moves back the size of the orifice is gradually diminished. The area of the orifices is so calculated that a constant retardation is given to the gun, and it is brought to rest at the end of the stroke.

The counterrecoil mechanism adopted on this mount is similar to the counterrecoil mechanism of the French type, as used on 155-millimeter guns. In this type of mechanism when the gun is fired, a piston attached to the gun yoke moves backward in an air-tight cylinder containing air at a pressure of several hundred pounds per square inch, still further compressing the air. The air pressure acting on the counterrecoil piston when the gun has reached the end of the recoil brings the gun back into battery or firing position.

The counterrecoil system which is used on this mount is located on the top of the gun, and has been changed into a combination of three cylinders, connected at the lower end by a bronze head. The piston attached to the yoke operates in the central cylinder. The system

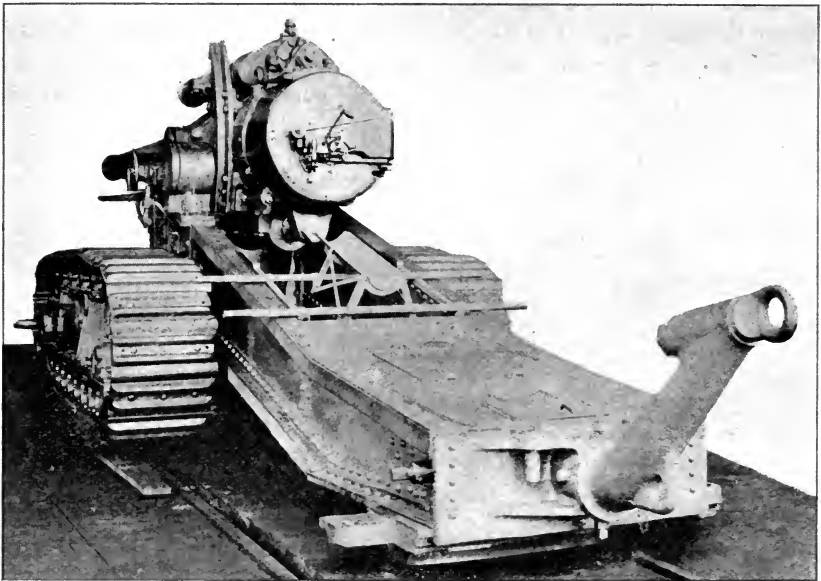

REAR VIEW OF CARRIAGE.

of liquid packing is retained but simplified and the entire system is made up of shapes and materials easily secured and is well adapted to American machining methods.

A traversing gear, incorporated in the carriage trail, permits of limited training either side of the center line. When a greater range of training is desired, the trail is either shifted on the ground or the carriage is mounted upon a firing platform which provides for training through a firing angle of 60° . A shell-loading tray, which rests on the carriage trail, is used to load shells into the breech.

The elevating gear consists of a simple combination of a handwheel, worm gear, rack and pinion. The sighting arrangements for the gun consist of a standard panoramic field sight fitted to a bracket attached to the gun carriage.

The track layer, which is of the double-tread caterpillar type, is designed to carry the mount over practically any kind of ground likely to be encountered in service. The proportions of the chain tracks are such as to produce a pressure of about 14 pounds per square inch upon the soil during transportation, which is approximately half that exerted by a horse. The track layer also serves as a stand or foundation for the mount during action.

A caterpillar tractor is used to draw this vehicle from one position to another. A limber hooked between the mount and the tractor supports the trail during transit; during action the limber and the tractor are withdrawn from the immediate field of danger.

The limber wheels are carried on taper axles and are equipped with grease cups for lubricating purposes. A pintle and lunette are provided on the axle in case it is desired to attach an ammunition or supply trailer for transportation. The limber is connected to the

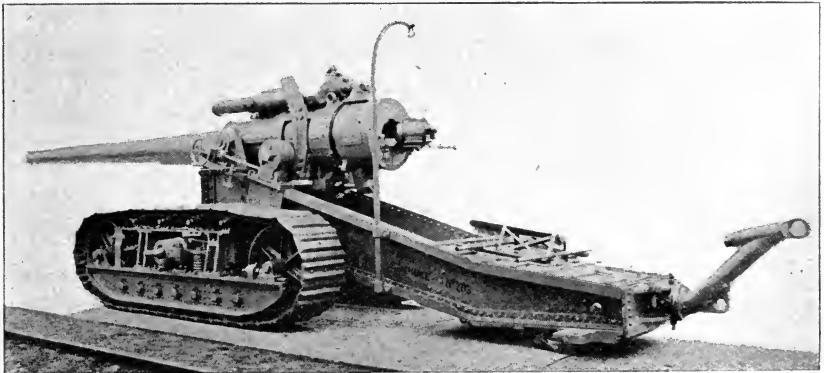

LEFT SIDE VIEW OF CARRIAGE IN BATTERY.

mount by means of a swivel pole end which is pivoted on the limber connection of the trail.

The firing platform provides a durable and substantial foundation, adaptable to various soil conditions and light enough to permit of easy and convenient transportation. The firing platform includes a forward table, upon which the track layers rest, and a rear thrust beam to which the trail is secured by suitable pins. The rear thrust beam is made in two sections, which, when combined, provide for training through an arc of 60° . One section may be used alone if desired. Training is accomplished by shifting the trail around the arc of the platform to the set of pin holes nearest the desired angle. Accurate adjustments in training are made with the traversing gear.

The 7-inch naval tractor mount is so designed that its weight is almost entirely supported by the track layers, but a small percentage of the weight being carried on the trail. When the mount is being pulled along an upgrade of appreciable slope, the center of gravity

is shifted and the weight of the gun may have a tendency to throw the trail in the air.

To preclude any such occurrence, eyebolts are secured to the gun yoke, which are used to draw the recoiling parts back sufficiently to bring about equilibrium.

Track grousers may be bolted to the track shoes when there is likelihood of the mount slipping sidewise during transport on hill-sides. In an actual road test this gun was pulled over rough ground and proved able to negotiate any ground over which the tractor itself was able to operate. Obstructions were mowed down, and yet the entire weight of the gun was so evenly and well distributed that no damage was done to roads negotiated. The mount functioned perfectly, remaining steady on the point of aim during continued firing. The caterpillar treads, locked in position by the brake, were as steady as a concrete foundation.

7-INCH GUN MARK II AND CARRIAGE MARK V.

The 7-inch, 45 caliber, naval rifle is built up of a tube, hoops, and locking rings. When erosion destroys the effectiveness and accuracy of the gun it may be rebuilt by boring out the tube and shrinking in a conical nickel-steel liner. The gun, without the breech mechanism, weighs 12.81 tons, while the weight of gun and breech mechanism is 28,700 pounds. The rifling is right hand of hook section and consists of 28 grooves and lands, having an increasing twist from zero at the origin to one turn in 25 calibers at a point 22 inches from the muzzle. The remainder of the twist is uniform. This gun is the heaviest and hardest hitting gun for which a mobile field mount has been requested by our Army.



CARRIAGE AND LIMBER IN TRAVELING POSITION (REAR VIEW).

The carriage, which supports the gun is a structural steel framework built up of standard shapes, consisting essentially of two steel trunnion bearing plates cross braced at each end to form a single unit with a central well into which the gun recoils. These side girders are riveted to the carriage trail, the carriage and trail forming a rigid unit, are supported on the carriage axle which turns in hubs mounted in the truck frames of the track layer.

On the left-hand side of the carriage is arranged the mechanism for elevating and depressing the gun. The traversing gear, which provides means for training 2° either side of the center line, is incorporated in the rear section of the trail. This gear consists of a steel plate resting on the ground underneath the trail; a worm shaft oper-

ated by ratchet wrenches shifts the trail with reference to the plate and enables the gun to be accurately trained.

Navy guns do not carry the trunnions attached directly to the gun, but are turned to a smooth surface on the outside. The cylindrical gun slide, on which the trunnions are attached, carries the gun; the trunnion seats are placed at the upper end of the carriage. The recoil and counterrecoil mechanisms are also attached to the gun slide, operating through pistons attached to the yoke. The gun runs in and out of the gun slide when recoiling, bronze liners being fitted to the inside of the slide to enable this to take place easily. The trunnions of the gun are mounted sufficiently high so that at maximum angles of elevation only a shallow trench need be dug to permit clearance for the recoil of a gun.

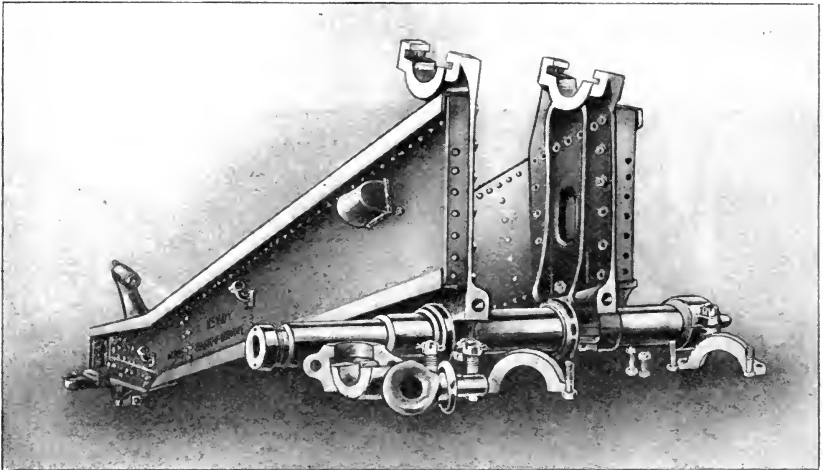

TOP CARRIAGE AND AXLE DETAILS.

The elevating arc segment, meshing with the pinion of the elevating mechanism, is bolted to a pad on the left-hand face of the slide. The teeth of the arc are cut on a pitch circle concentric with the trunnion centers to permit of a 40° movement of the slide in a vertical plane, starting from horizontal. The upper and lower extremities of the arc are fitted with limiting stops to prevent jamming.

The hydraulic brake.—The energy of recoil is checked and dissipated by means of a hydraulic brake mounted on the bottom of the slide. This mechanism is made up of a piston operating in a cylinder filled with liquid and rigidly fixed to the slide. The piston is attached to the gun yoke by the piston rod which passes through a stuffing box in the rear end of the cylinder. Two orifices are provided in the piston head for throttling rods which are arranged longitudinally in the cylinder. In battery, all the liquid is in rear of the piston. As the piston recedes during recoil, the liquid is forced around the throttling rods through the orifices in the piston to the forward end

of the cylinder, dissipating the energy through the frictional heat generated. The cross section of the throttling rods, around which the liquid must flow in passing through the orifices, is such that a pressure approximately uniform is exerted upon the liquid throughout the period of recoil. The length of recoil is 32 inches.

Incorporated in the cylinder head is a counterrecoil chamber into which the recoil liquid flows during recoil. When the gun is brought back to battery by the counterrecoil mechanism, its momentum is

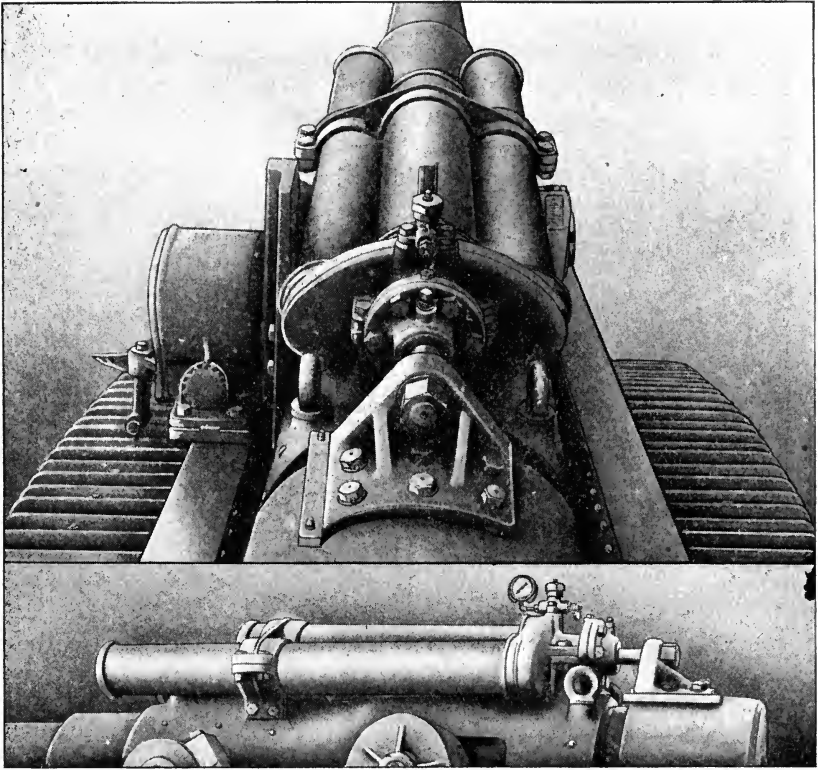

ASSEMBLED VIEW OF HYDRAULIC BRAKE.

checked through the action of a counterrecoil plunger, mounted on the forward face of the piston, as it enters the chamber and forces the liquid back into the cylinder through the orifice between the plunger and the plunger bushing screwed into the mouth of the chamber. This action takes place during only the last 14 inches of counterrecoil stroke.

The liquid used in the hydraulic brake consists of a mixture of 4 parts glycerine and 1 part water, by volume. This liquid is poured into the cylinder through a filling hole on the right-hand side of the cylinder head.

The upper portion of the cylinder head is arranged to form an expansion chamber to provide for the expansion of the liquid which results from the frictional heat generated in the cylinder. When expansion of the liquid takes place with continued firing, the increased volume of the liquid simply compresses the air in the expansion chamber instead of acting to prevent the return of the gun to battery. To assure the presence of a definite amount of air in the expansion chamber at all times, the filling hole is fitted with a tube which extends down into the chamber and traps the desired volume of air when the cylinder is filled.

Counterrecoil system.—Energy to return the gun to battery and to maintain it in that position at all angles of elevation is obtained by means of a pneumatic counterrecoil system, mounted on the top of the

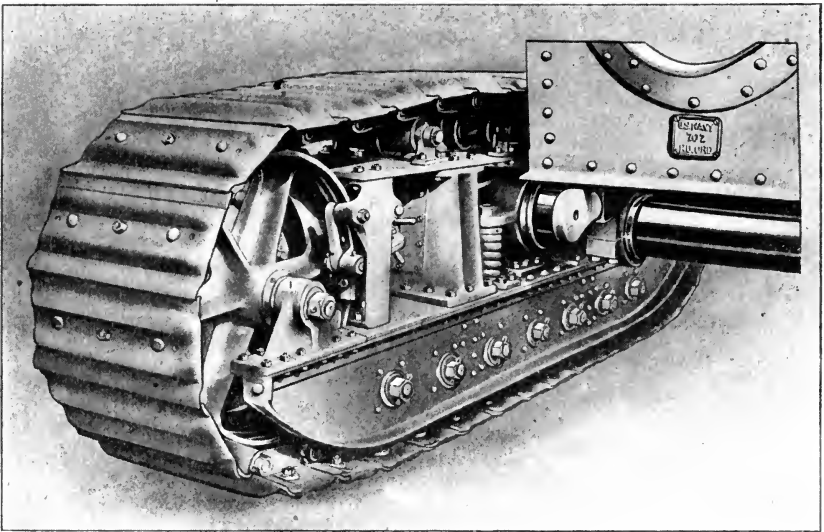

VIEW OF AXLE MOUNTED IN TRACK LAYER.

the slide. A piston, operating in an air cylinder and connected to the gun yoke by a piston rod, serves to compress the air within the cylinder when the gun recoils. At the end of recoil, the compressed air acts upon the piston to return the gun to battery. On either side of the air cylinder and connected with it through a port is an air tube which serves as a reservoir.

Since it is necessary for the counterrecoil system to support the weight of the gun and breech mechanism against gravity, the system is charged initially with air at 300 pounds per square inch, gauge pressure. This pressure assures the proper functioning of the counterrecoil mechanism at angles of elevation up to approximately 34° . It is apparent that the factor of gravity decreases with the angle of elevation and hence less pressure is required to bring the gun to battery when it is fired at angles near horizontal.

When charged to 340 pounds pressure, the mechanism will function properly at all angles; however, if the cylinder should be charged only to, say, 225 pounds, the mechanism may be relied upon to return the gun to battery at angles of elevation up to 23 or 24°. To insure return of the gun to battery when firing at angles above 34°, air cylinders should be charged in accordance with the instructions, and to prevent breakage of the gauge glass and to preserve the accuracy of the instrument, it is recommended that the pressure gauge be removed before firing.

The elevating gear train from the rack on the slide to the handwheel on the left side of the trail is made up of a pinion and shaft in mesh with the elevating arc. One turn of the elevating handwheel moves the gun 56' 17'' in elevation or depression.

The axle, a steel forging extending across the width of the carriage is supported in the track layer by a hub bracket which in turn is carried by the structure of the girder on which the sprocket and truck

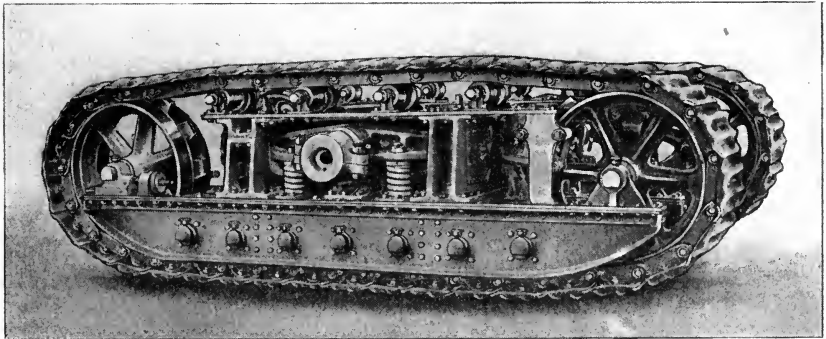

SIDE ELEVATION OF TRACK LAYER.

wheels are mounted. This bracket is held by oscillating bearings and is spring supported so that the caterpillar may adjust itself to any unevenness in the road when the gun is in motion. When the gun is placed in firing position, the springs are taken up by means of holding down screws in order that the mount may keep steady on the point of aim while firing.

The function of the hub springs is to impart to the mount a degree of resiliency during transit. However, when firing, resiliency in the mount is undesirable and often dangerous, thus before firing the springs are compressed until the hubs bear directly upon the truck frames. This is accomplished by means of adjusting screws screwed down on the hub bearing blocks until the springs are compressed and the hubs rest solidly upon the truck frames.

The track itself consists of an endless belt of cast steel links connected by hardened pins, each link carrying a corrugated forged-steel plate which makes contact with the ground. The plates overlap when horizontal so that a continuous surface is presented. To prevent the

corrugated surface of the tread from slipping in soft ground, detachable grousers are provided.

The track links run over a large idler wheel, a sprocket wheel, seven truck rollers, and four track rollers on each caterpillar track layer. The sprocket wheels carry but little of the load except when the gun is descending a grade or when the brake is applied to the mount. For smooth running and reliability, roller bearings are fitted in the truck and idler rollers, the ends of the rollers being closed by steel plates to prevent the entrance of dirt when the mount is hauled through mud, sand, or soft earth. A brake is provided to permit control of the mount when descending hills and also to lock the caterpillar in position when the gun is set up for firing. The brake consists of a toggle joint operating on the rim of one of the sprocket wheels, the tension applied being controlled by an adjustable spring.

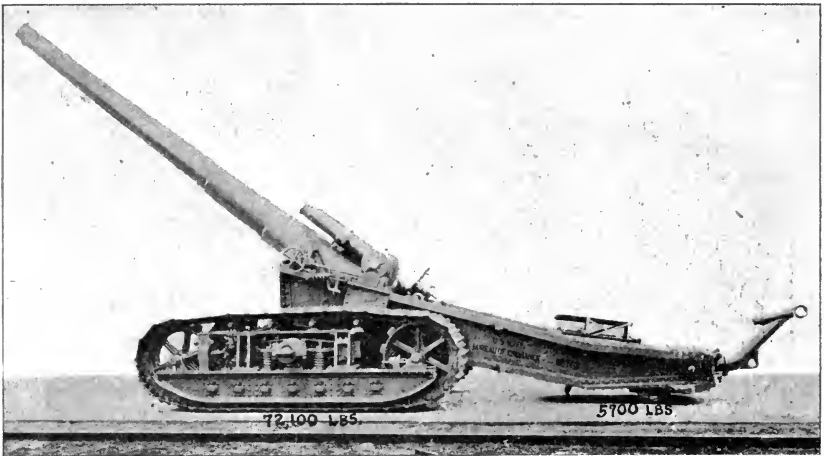

CARRIAGE IN BATTERY POSITION, SHOWING MAXIMUM ELEVATION OF GUN.

Simple as the brake is it has been exceedingly satisfactory in operation in controlling the heavy mount on steep grades and in checking any tendency of the mount to move on firing.

The track is carried around two track idler wheels which are provided with bearings mounted on the extremities of the track frame. The aft idler wheel bearings are so mounted that they may be moved backward or forward as necessary to adjust the tension and to take up wear on the links and shoes.

Friction brakes operating against the forward idler wheels are mounted on the truck frames. These brakes are of the spring release type and are applied by means of handwheels functioning through yokes and levers to the brake shoes.

The quadrant sight (Schneider) is mounted on the left trunnion of the carriage both in traveling and in action.

8-INCH HOWITZER MATÉRIEL (VICKERS).

Success has been obtained with the 8-inch howitzer artillery for preliminary bombardment which precedes an infantry attack. This caliber is mobile in a sense, but there are limits to its mobility, for there comes a time when its advance must stop. When these howitzers have to be transported over land full of huge craters, with the roads entirely destroyed, the country encumbered with all kinds of débris and frequently reduced to a sea of mud, it can be easily seen why a successful "push" usually nets a considerable gain in captured artillery. If the trenches give way, it is almost impossible to get the heavy howitzers away quickly enough to save

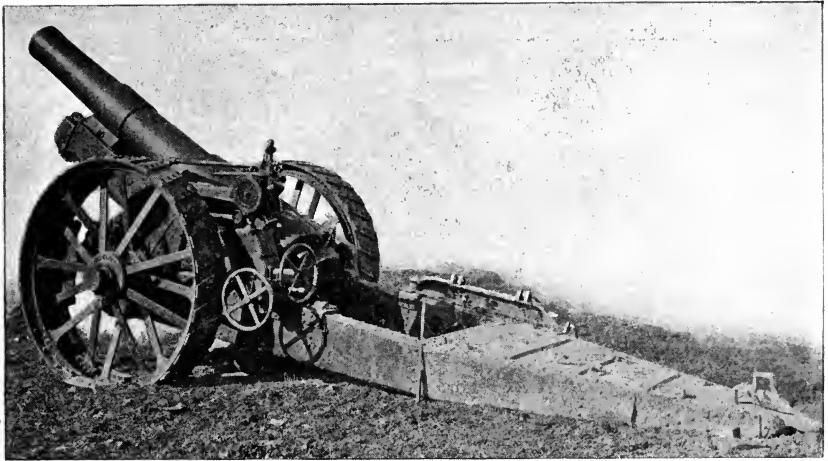

CARRIAGE IN BATTERY POSITION.

them from being captured by the enemy. Thus, by mobile artillery is meant that which can be moved around essentially as part of the infantry.

The howitzer, being comparatively thickset and short when compared with a gun of the same caliber, is capable of greater angle of elevation than the same caliber of gun. The gun is primarily intended for attacking troops, while the chief aim of the howitzer is to destroy incumbrance such as trenches, barbed wire, pill boxes, and the like. A shell that travels from the howitzer ascends at a high angle and drops almost vertically. The explosion of a shell so fired is much more effective than one that is fired with only a slight elevated trajectory, as in the case of the field gun.

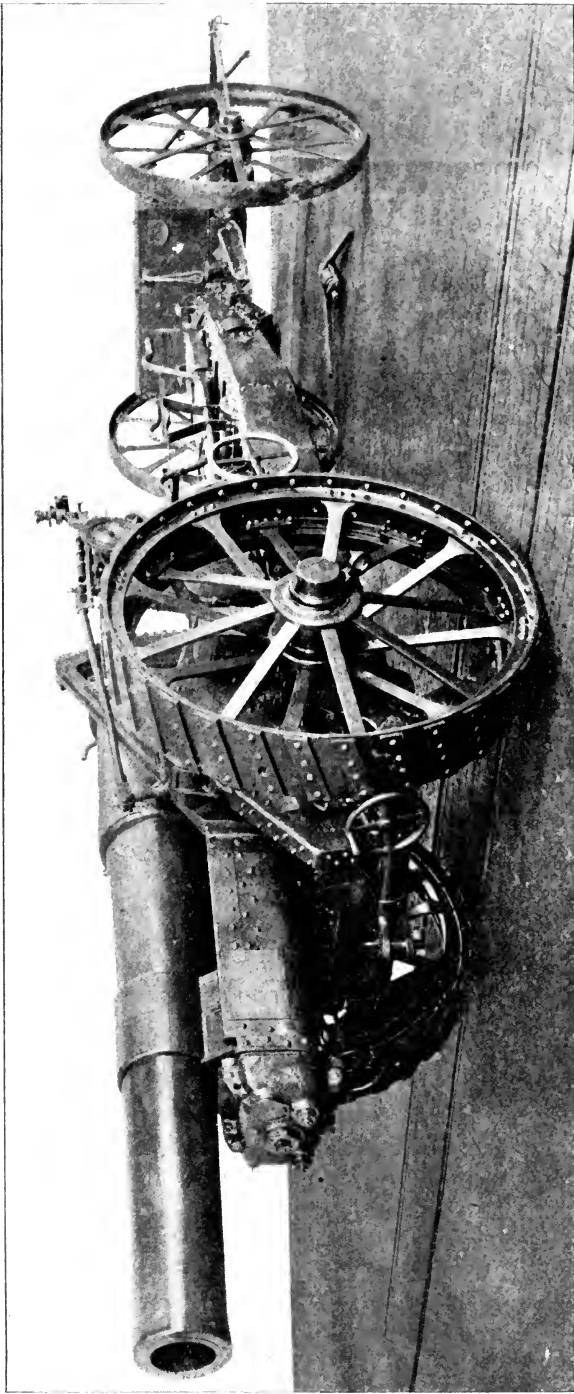

8-INCH HOWITZER CARRIAGE, MODEL OF 1917 (MARK VI), IN TRAVELING POSITION.

The 8-inch howitzer, being mounted on a wheeled carriage and not having to be disassembled for transportation, is much more mobile than the 9.2-inch or 240-millimeter howitzer. This howitzer when set up ready for firing rests on and is braced upon a firing platform, which is transported on a two-wheeled wagon, the wagon being attached to the howitzer carriage and drawn as part of the unit with the carriage and limber by a tractor. On reaching the spot selected for position the firing platform is buried flush with the surface of the ground, furnishing a steady emplacement from which to fire.

The 8-inch howitzer matériel is called the "Vickers" model of 1917, of which there are in use two types, the Mark VI and Mark VII. The main differences between the Mark VI and the Mark VII being that the former has a lower muzzle velocity and consequently a shorter range than the latter, also that the Mark VII has a barrel of the "wire wound" construction, whereas the Mark VI type is of the "built up" construction. The Mark VII is also longer and heavier than the Mark VI.

The Mark VII has lately been superseded by a Mark VIII $\frac{1}{2}$, the difference between the two being that the powder chamber walls of the Mark VII proved to be too thin, while the Mark VIII $\frac{1}{2}$ overcomes this defect by having thicker powder chamber walls. Due to the fact that the Mark VIII $\frac{1}{2}$ howitzer has a greater muzzle velocity, and consequently a greater maximum range than the Mark VI by some 15 to 20 per cent, the former is the preferred type.

The life of the howitzers before relining is necessary varies greatly. The number of rounds they are capable of firing before the lining becomes badly worn depends on whether light or heavy propelling charges are used. The use of light propelling charges and greater trajectory elevation to get the desired range is recommended rather than heavy charges and low elevation. From information based on actual experience the average life of the 8-inch howitzer, Mark VI, is 7,800 rounds, while that of the Mark VIII $\frac{1}{2}$ is 3,000 rounds.

Comparative table of weights, dimensions, and ballistics for 8-inch howitzers, Marks VI and VIII $\frac{1}{2}$ and 6-inch gun, Mark XIX.

	Mark VI howitzer (Mark VI carriage).	Mark VIII $\frac{1}{2}$ howitzer (Mark VII carriage).	Mark XIX gun (Mark VIII-A carriage).
Weight of howitzer or gun, including breech mechanism.....	6,552	7,730	10,248
Weight of gun or howitzer without breech mechanism.....	6,132	7,310	9,940
Total length of howitzer or gun.....	127.6	148.3	219.22
Length of howitzer or gun.....	15.9	18.5	36.5
Distance to center of gravity from breech, unloaded.....	42.6	50.5	71.95
Distance to center of gravity from breech, loaded.....	42.3	50.6	71.65
Length of bore.....	117.7	138.4	210.0
Length of bore.....	14.7	17.3	35.0
Length of rifling.....	102.11	99.52	170.75

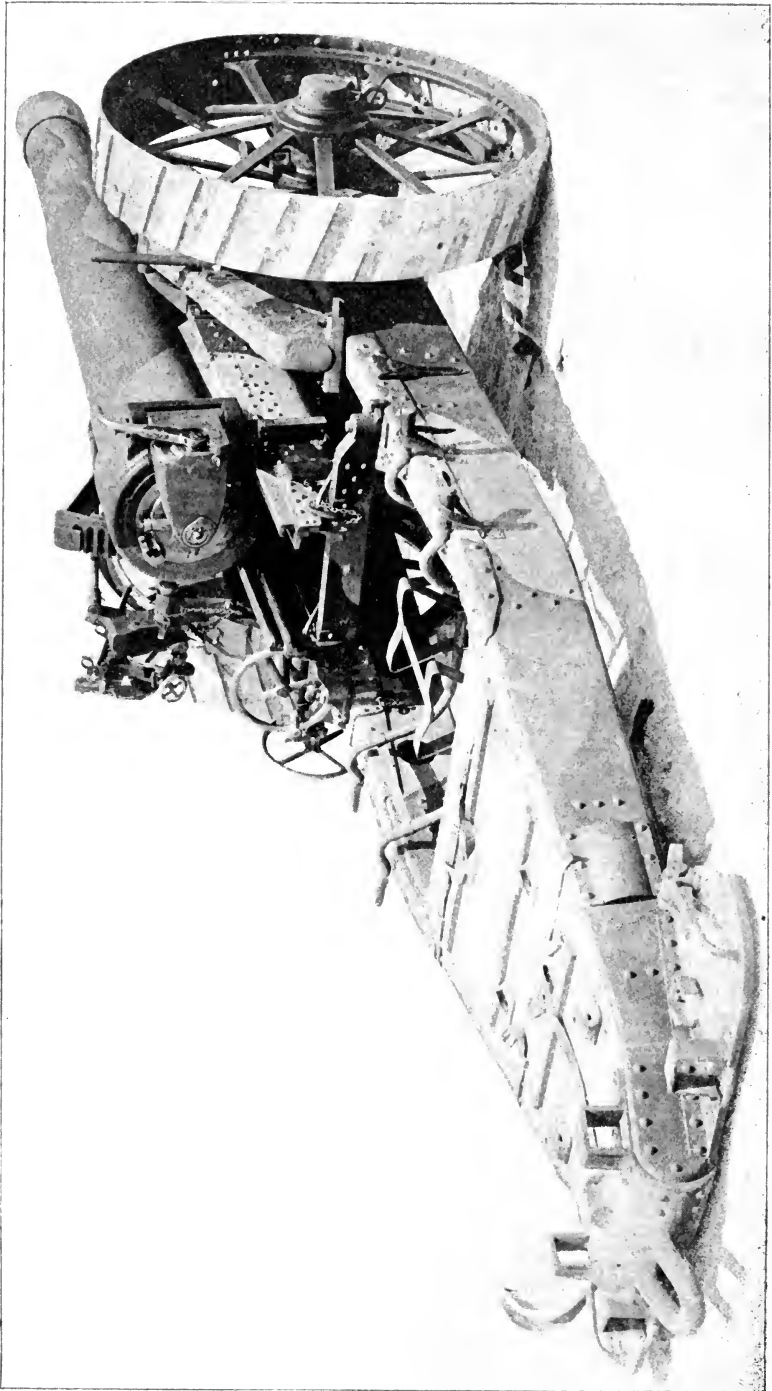

8-INCH HOWITZER CARRIAGE, MODEL OF 1918 (MARK VII), IN BATTERY POSITION.

Comparative table of weights, dimensions, and ballistics for 8-inch howitzers, Marks VI and VIII½ and 6-inch gun, Mark XIX—Continued.

	Mark VI howitzer (Mark VI carriage).	Mark VIII½ howitzer (Mark VII carriage).	Mark XIX gun (Mark VIII-A carriage).
Number of grooves.....	48	48	36
Twist (uniform)..... R. H.	1 in 15	1 in 25	1 in 30
Travel of projectile in piece..... inches.	104.96	102.72	174.0
Weight of projectile..... pounds.	200	200	100
Weight of powder charge..... do.	10.75	17.5	23.0
Maximum powder pressure..... do.	30,250	30,240
Muzzle energy..... foot tons.	2,345	3,228	3,308
Muzzle velocity..... feet per second.	1,300	1,525	2,350
Length of recoil..... inches.	60-24	52-24	42-20
Maximum elevation..... degrees.	50	45	38
Range at 15 degrees elevation..... yards.	6,430	7,400	11,300
Range at 20 degrees elevation..... do.	7,810	8,900	13,100
Range at 25 degrees elevation..... do.	8,920	10,500	14,600
Range at 30 degrees elevation..... do.	9,800	11,540	15,960
Range at 45 degrees elevation..... do.	10,710	12,300
Maximum range..... do.	10,760	12,360	17,560

The Mark VI howitzer has a muzzle velocity of 1,300 feet per second and a maximum range of 10,760 yards and is of British design and of both British and American manufacture. The Mark VII howitzer has a muzzle velocity of 1,525 feet per second and maximum range of 12,280 yards and is of British design and manufacture. The Mark VIII½ is an American modification of the British wire-wound Mark VIII howitzer to permit of a built up type of construction and is strictly of American manufacture. The Mark VIII½ has the same muzzle velocity and range as the Mark VIII.

Due to the combination of British and American manufacture, there are several types of breech mechanism in service; the two main types are the T and the French percussion type.

The three types of carriages differ but slightly in design. Each is a two-wheeled vehicle with a box-shaped trail, the latter being cut away to provide clearance for the recoil of the howitzer or gun when fired at high angles of elevation. The trails of the Mark VII and VIII-A types are modified to provide a larger clearance to accommodate the Mark VIII½ howitzer and Mark XIX gun (see p. 246) and are also strengthened to withstand the greater energy of recoil.

The howitzer is mounted in a cradle in which it is free to recoil under the control of a hydraulic recoil cylinder. After recoil it is returned to firing position by means of a pneumatic recuperator. The carriage permits of firing at high angles of elevation, and as the elevation is increased the length of recoil is proportionally decreased by a cut-off gear fitted to the cradle and buffer in order that the howitzer will not strike the trail or ground when fired. The recoil mechanism is of the hydropneumatic type with a variable recoil mechanism which lessens the length of recoil the greater the elevation given the howitzer or gun. The liquid used in the mechanism is British buffer oil.

The elevating mechanism permits a movement of 50° maximum elevation for the Mark VI carriage, 45° for the Mark VII carriage, and 38° for the Mark VIII carriage.

The cradle pivots on its trunnions and rests in bearings provided in the top carriage, which in turn is pivoted at its front center to a transom on the trail in such a manner that it is free to rotate under



REAR VIEW OF CARRIAGE, SHOWING MAXIMUM ELEVATION OF HOWITZER.

control of the traversing gear, 4° to the right or 4° to the left of the center line of the trail, a total of 8° traverse for each of the three types.

A quick-loading gear is fitted to the cradle for bringing the howitzer rapidly to the loading position ($7^{\circ} 30'$ elevation) after firing, and vice versa.

The trail is composed of two side members supported at the front end of the axle and terminating in a spade at the rear end. Screw brakes for use in firing or traveling are fitted to either side at the forward end of the trail.

A traveling lock is provided on the trail to lock the trail and cradle together to prevent strains on the elevating and traversing mechanisms when traveling.

The wheels are made entirely of steel and have wide tires fitted with steel cleats to ensure good traction.

The sighting gear is composed of a rocking bar sight with panoramic sight and clinometer for the usual method of sighting and a dial sight for the quick laying of the piece.

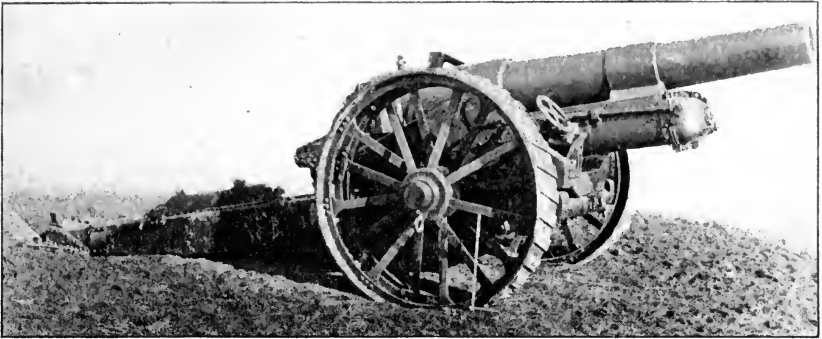

RIGHT SIDE VIEW OF CARRIAGE IN BATTERY.

Comparative table of weights and dimensions of 8-inch howitzer carriages, Marks VI and VII, and 6-inch gun carriage, Mark VIII-A.

	Mark VI.	Mark VII.	Mark VIII-A.
Weight of carriage (only).....pounds..	12,548	12,320	12,548
Weight of carriage, limber, and howitzer or gun.....do.....	21,796	22,650	25,110
Weight behind team, heaviest load.....do.....	29,540	30,499	32,950
Weight of howitzer or gun carriage in firing position.....do.....	19,100	20,050	22,796
Weight at end of trial.....do.....	528	532
Volume of liquid in recoil cylinder.....pints.....	54.0	64.8	64.8
Volume of air in recuperator cylinders.....cu. in.....	1,700	1,693
Volume of liquid in recuperator cylinders.....pints.....	70.0	76.8	76.8
Initial pressure.....pounds per sq. in.....	685	749	740
Maximum air pressure.....do.....	1,008	1,859	1,678
Height of bore above ground.....inches.....	60	60	60.5
Height of sight line, panoramic sight.....do.....	69	69
Width of carriage over axle.....do.....	95.8	95.8	95.8
Angle of traverse.....degrees.....
Angle of traverse with firing platform.....do.....
Diameter of wheels.....inches.....	66	66	66
Width of tires, carriage.....do.....	12	12	12
Width of track, center line to center line of wheels.....do.....	76	76	76
Maximum length of carriage, firing position (howitzer or gun horizontal).....inches.....	256.5	276.5	322.5
Maximum length of carriage, traveling position (howitzer or gun horizontal).....inches.....	260	280	325

The carriage limber is made of steel and has wide steel-tired wheels. At the rear is a limber hook which engages the lunette at the trail end of the carriage. A chest is mounted on the limber, providing seats for the personnel, and fittings on the interior for carrying tools.

The limbers which were manufactured in England have wooden chests, while those manufactured in America have steel chests. A connecting pole provides for motor transportation when traveling, the units being arranged in the following order: Limber, gun or howitzer carriage, and platform wagon, which combination is drawn by a tractor.

These types of carriages are provided with a platform by means of which a traverse of 26° right and 26° left is obtainable. The platform is used whenever conditions and time permit emplacement. For transportation the platform is disassembled and placed on a transport wagon, which consists of two wheels and an axle, to which the parts of the platform are securely clamped.

Eight-inch howitzer matériel (British) consists of:

Model of 1917 (Vickers Mark VI and Mark VII).

Model of 1918 (Vickers Mark VII).

Limber, model of 1917 (Vickers).

Firing platform and wagon, model of 1917 (Vickers).

The 8-inch howitzer matériel, model of 1917 (Vickers Mark VI), consists of:

Carriage, model of 1917 (Vickers Mark VI).

Howitzer, model of 1917 (Vickers Mark VI).

Limber, model of 1917 (Vickers).

Firing platform and wagon, model of 1917 (Vickers).

The 8-inch howitzer matériel, model of 1918 (Vickers Mark VII), consists of:

Carriage, model of 1918 (Vickers Mark VII).

Howitzer, model of 1918 (modified from Vickers Mark VIII to United States Mark VIII $\frac{1}{2}$).

Limber, model of 1917 (Vickers).

Firing platform and wagon, model of 1917 (Vickers).

The above matériel is of British design and of both British and American manufacture.

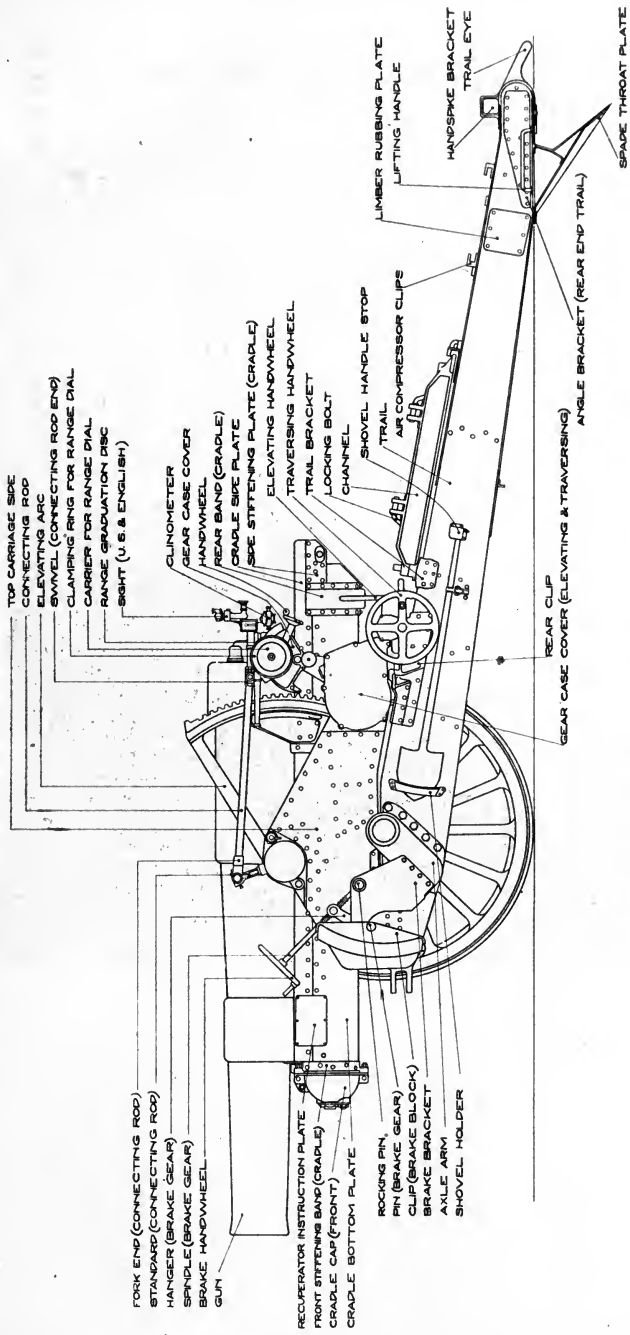

8 IN. HOWITZER CARRIAGE, MODEL OF 1917 (VICKERS MARK VI)
LEFT SIDE ELEVATION



8-INCH HOWITZER AND CARRIAGE (BRITISH).

The *Mark VI howitzer* is of the built-up-construction type and consists of a tube over which is shrunk a jacket. Front and rear guide rings provide means of supporting the howitzer in the cradle. A breech ring is also shrunk on for additional strength and carries a lug for connecting the gun to the recoil mechanism, and a breech bushing is provided for reception of the breechblock. The total length of this howitzer is about $10\frac{1}{2}$ feet and its maximum range is approximately 10,760 yards; this howitzer is mounted on the *Mark VI carriage*.



REAR RIGHT SIDE OF CARRIAGE IN FIRING POSITION.

The *Mark VIII $\frac{1}{2}$ howitzer* is also of the built-up-construction type, but differs from the *Mark VI* howitzer in that it consists of two tubes, an inner and an outer, over which is shrunk the jacket. The jacket in this case supports the howitzer without the use of guide rings. A breech ring is shrunk on over the jacket and carries a lug for connecting the gun to the recoil mechanism. A breech bushing similar to that of the *Mark VI* is fitted for the breech mechanism. The total length of this howitzer is about $12\frac{1}{2}$ feet and its maximum range is approximately 12,360 yards. This howitzer is mounted on the *Mark VII carriage*.

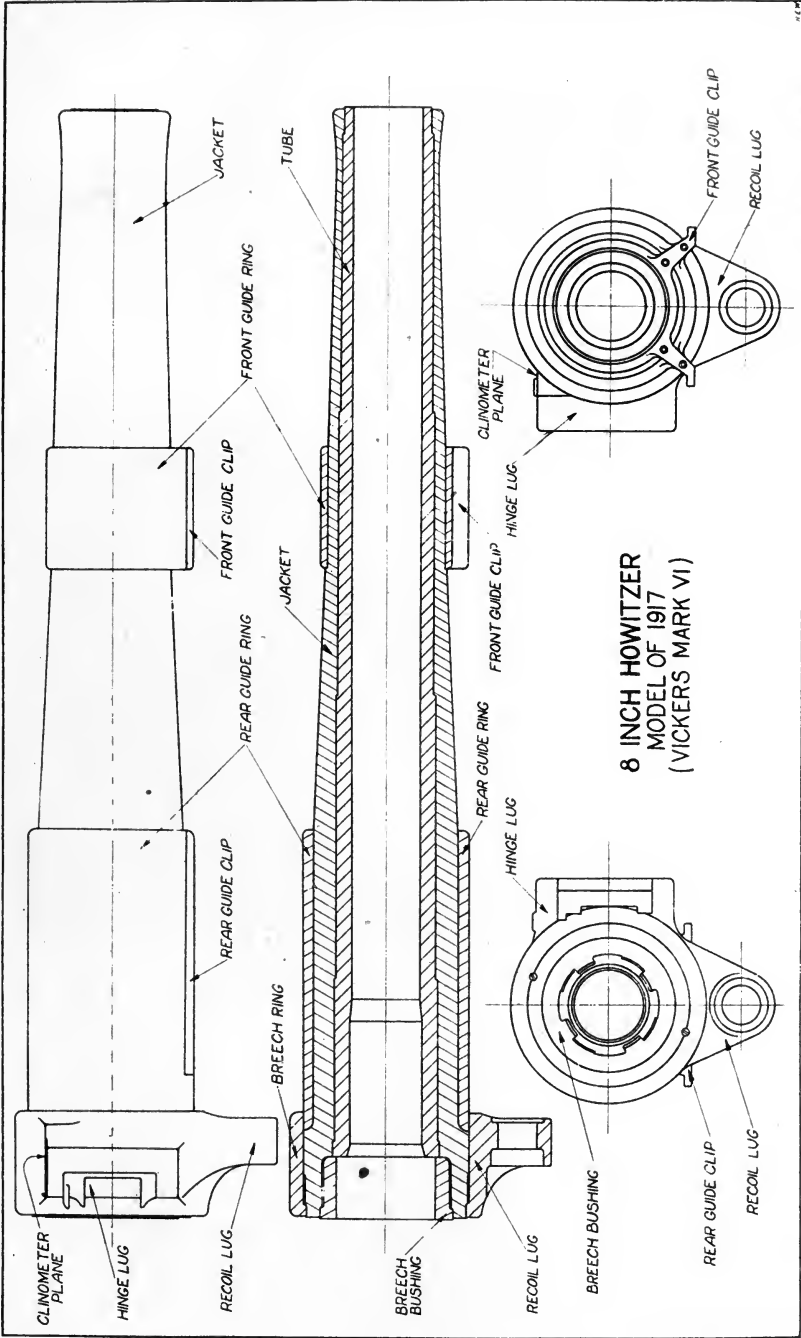

**8 INCH HOWITZER
MODEL OF 1917
(VICKERS MARK VI)**

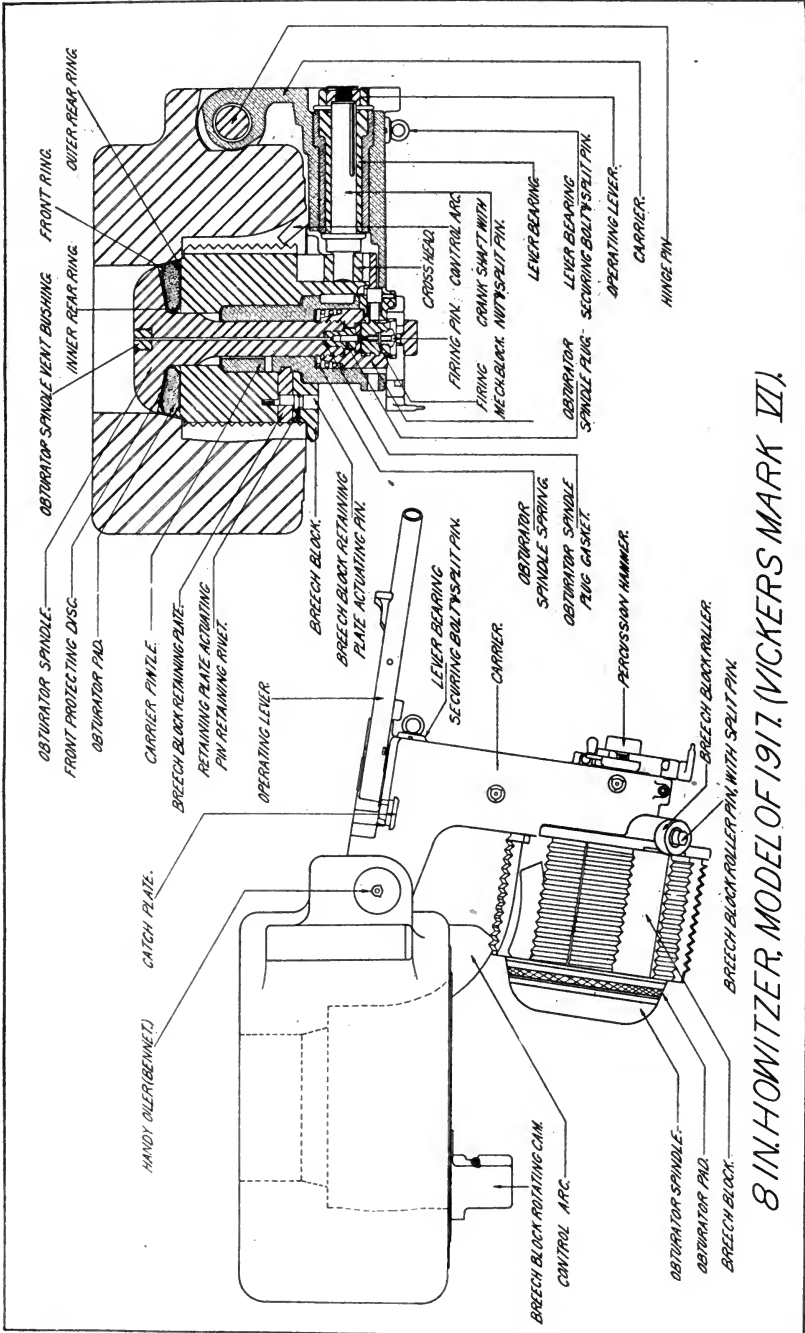

8 IN. HOWITZER, MODEL OF 1917. (VICKERS MARK VI.)

The breechblock is of the interrupted-screw type. It is operated by a lever on the right-hand side of the breech, which by one motion releases the screw threads and opens the breech, or *vica versa*, on closing.

The forward mushroom-shaped head of the breechblock is equipped with a flexible asbestos ring, known as the obturator pad. On firing, this ring is compressed and acts as a gas check to prevent the leakage of powder gases back through the breech. It has sufficient resiliency to resume its original form after firing, as described on page 216.

For firing the charge, two separate types of igniters or primers are used. The one known as the T tube consists of a small T-shaped copper tube which fits into a suitable socket in the breech; it is fired by pulling a friction wire out of the tube by means of a lanyard. The

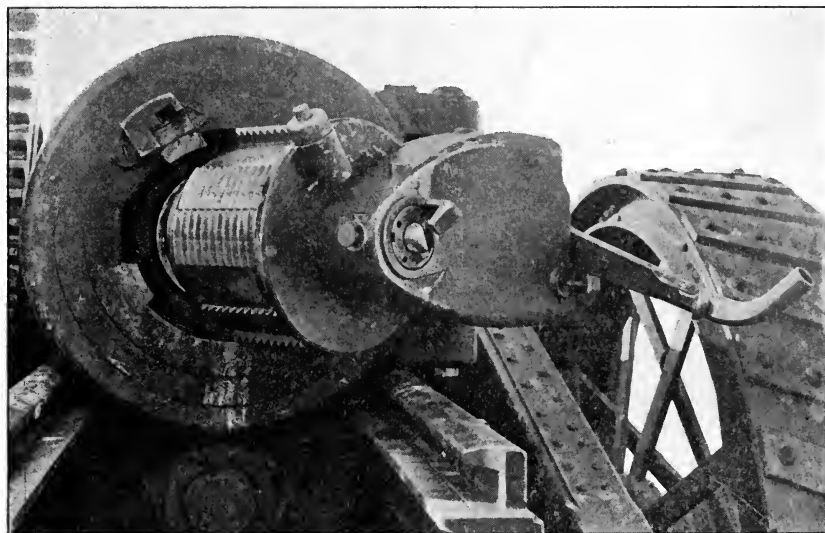

BREECH BLOCK.

other type, the percussion primer, is very similar in construction to a blank rifle cartridge. It fits a percussion firing mechanism on the breech which fires the primer by means of a hammer operated by the lanyard. This mechanism is common and interchangeable with the 155 millimeter gun and howitzer; also the 240 millimeter howitzer.

Howitzers fitted for one type of primer will not permit the use of the other type. Both types have a safety lock, which prevents firing when the breech is not entirely closed.

The recoil mechanism is of the hydropneumatic long-recoil type and contains both recoil brake and recuperator.

The recoil mechanism is an hydraulic brake to absorb the energy of recoil of the piece. It consists of a piston rod and piston traveling in an oil-filled cylinder. The piston rod is connected to the cradle

**8-INCH HOWITZER
MODEL OF 1917 — VICKERS, MARK VI
FIRING MECHANISM**

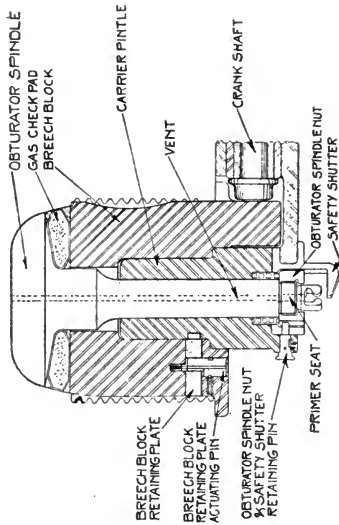
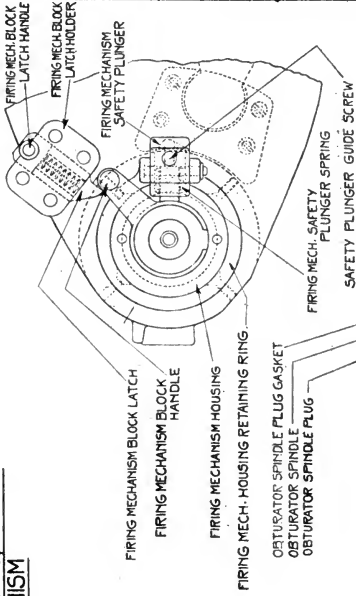
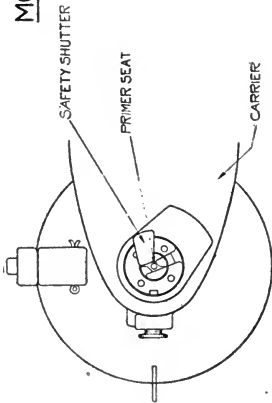

ENGLISH "T" TUBE TYPE

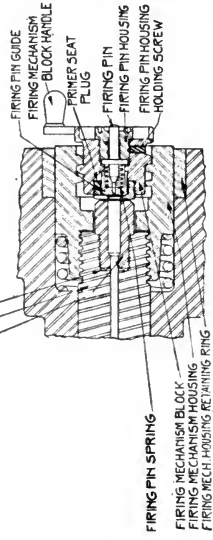

FRENCH TYPE

which remains stationary while the howitzer recoils. The cylinder block is connected to a lug on the howitzer and recoils with it so that when the gun is fired the piston is forced against the oil in the cylinder. Ports are provided in the piston to permit of the passage of some of the oil. At the beginning of the recoil a large quantity of oil is permitted to pass, but as the howitzer further recoils a valve on the piston rod, operated by lugs sliding in spiral grooves in the cylinder walls, gradually closes the port so that no oil can pass and the howitzer is brought gradually to rest.

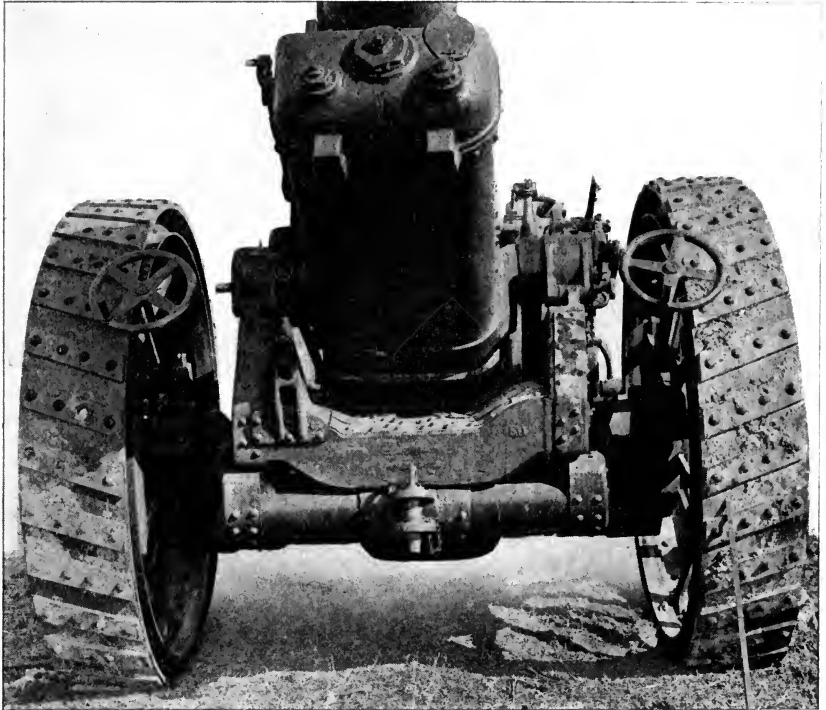

FRONT VIEW OF HOWITZER CARRIAGE.

In order to prevent the gun striking the ground when firing at high elevation, a method is provided for automatically closing the piston valves sooner as the elevation increases, thus shortening the recoil. The mechanism which accomplished this feature is known as the valve turning gear.

The rear end of the piston rod is extended and so designed that it forms a counterrecoil buffer when it enters a suitable chamber bored out in the buffer plug. This buffer prevents violent return into firing position after recoil.

The recuperator or counterrecoil mechanism serves to return the howitzer to firing position after recoil. It consists of two liquid cyl-

inders which are connected in turn with two air cylinders. On recoiling, the recuperator pistons force the oil out of the recuperator cylinders into the air cylinders, thereby highly compressing the air. When this air expands to its original volume it drives the oil back against the recuperator pistons, thereby returning the howitzer to firing position. The recuperator also acts as an auxiliary recoil buffer, absorbing up about 10 per cent of the energy of recoil. The air in the recuperator is maintained at a pressure of about 700 pounds per square inch in order to prevent the howitzer slipping back on the cradle at high elevations. A suitable pump is provided with the material for maintaining this air pressure.

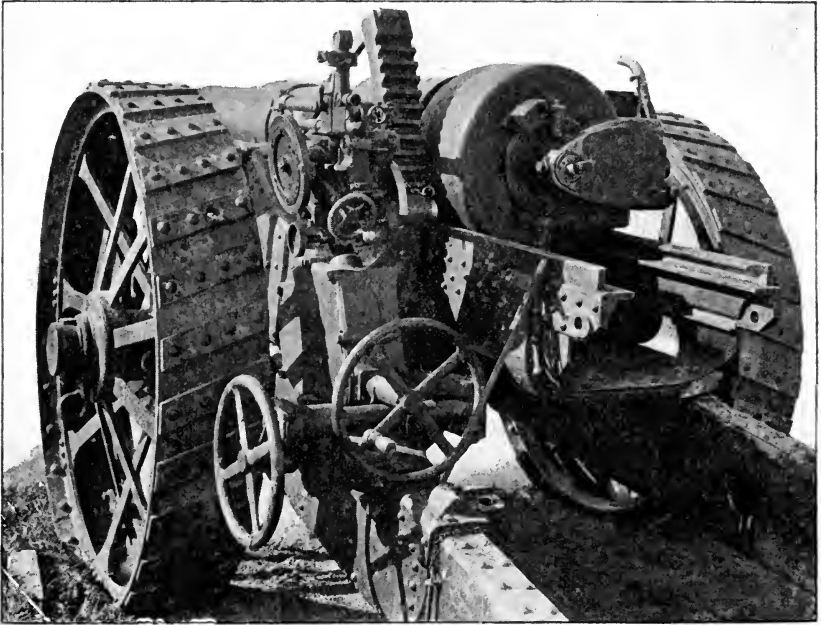

ELEVATING AND TRAVERSING MECHANISM.

The carriage consists of a top carriage, cradle, trail, wheels with axles, and the elevating and traversing gear. The Mark VI and Mark VII carriage are similar in design and differ only in that Mark VII has a slightly larger recoil mechanism and the trail is cut out somewhat to allow for the greater length of the howitzer recoil.

The top carriage is built up of nickel-steel plate and carries the trunnion bearings for the cradle. It is pivoted in the front transom of the trail, so as to permit the necessary traverse.

The cradle which carries the recoil mechanism and provides slide ways for the recoil of the howitzer when in action, is supported by the trunnion bearings of the top carriage.

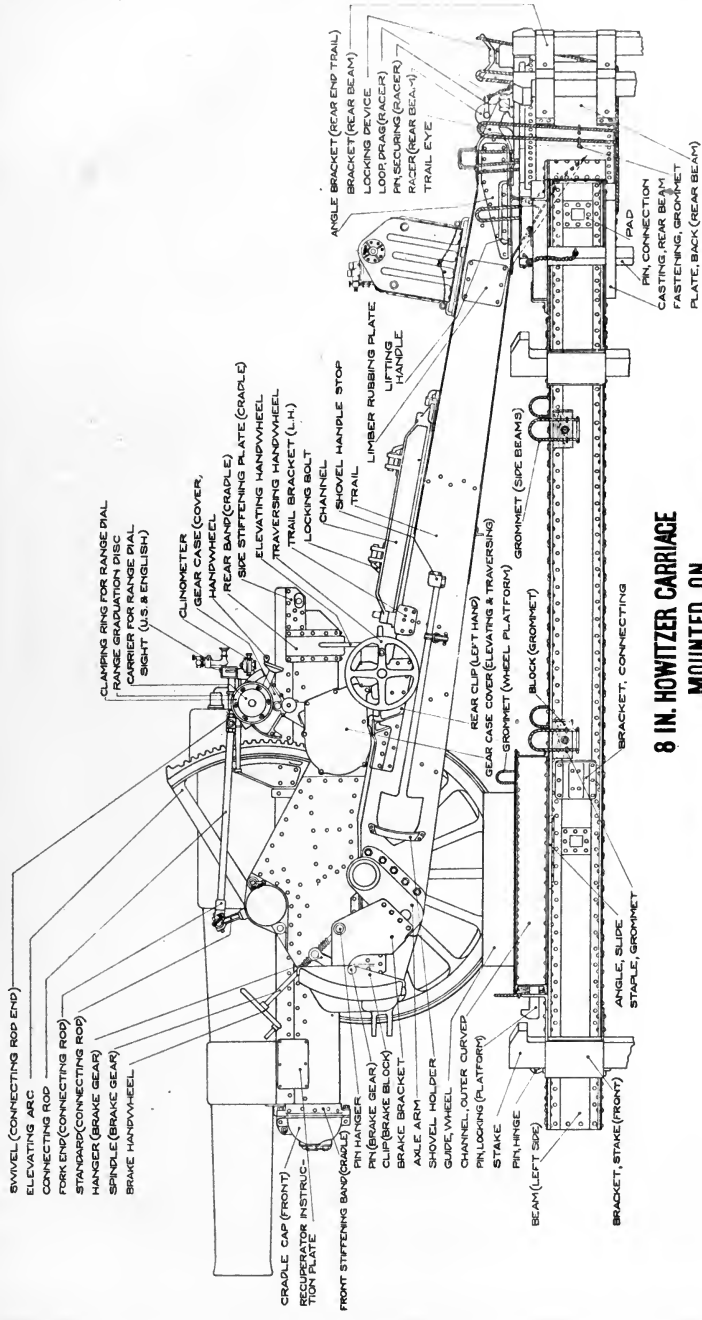

8 IN. HOWITZER CARRIAGE
 MOUNTED ON
 HOWITZER FIRING PLATFORM MODEL OF 1918



**8 IN. HOWITZER CARRIAGE (VICKERS)
SIGHT ASSEMBLED**

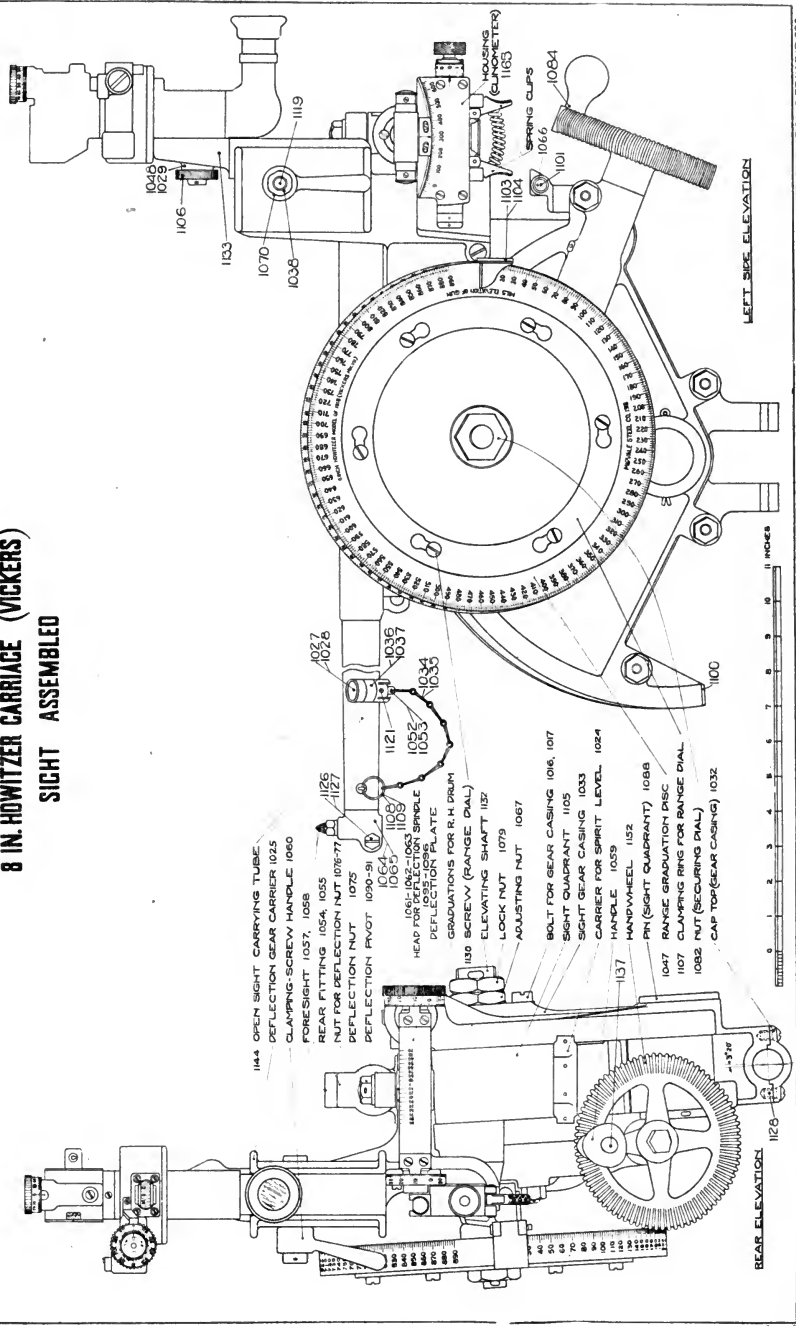

- 1046 OPEN SIGHT CARRYING TUBE
- 1070 DEFLECTION GEAR CARRIER 1025
- 1036 CLAMPING-SCREW HANDLE 1060
- 1037 FORESIGHT 1037, 1069
- 1035 REAR FITTING 1054, 1055
- 1026 NUT FOR DEFLECTION NUT 1076-77
- 1027 DEFLECTION NUT 1075
- 1028 DEFLECTION PIVOT 1090-91
- 1029 HEAD FOR DEFLECTION SPRING
- 1030 DEFLECTION PLATE
- 1031 GRADUATIONS FOR R.H. DIAL
- 1032 SCREW (RANGE DIAL)
- 1033 ELEVATING SHAFT 132
- 1034 LOCK NUT 1079
- 1035 ADJUSTING NUT 1067
- 1036 BOLT FOR GEAR CASING 1016, 1017
- 1037 SIGHT QUADRANT 1105
- 1038 GEAR FOR CASING 1033
- 1039 CARRIER FOR SPIRIT LEVEL 1024
- 1040 HANDLE 1059
- 1041 HANDWHEEL 1152
- 1042 PIN (SIGHT QUADRANT) 1068
- 1043 RANGE GRADUATION DISC
- 1044 CLAMPING RING FOR RANGE DIAL
- 1045 NUT (SECURING DIAL)
- 1046 CAP TOP (GEAR CASING) 1032

LEFT DISC ELEVATION

REAR ELEVATION

The *trail* is of the solid type, cut out to provide clearance for the howitzer to recoil. The spade is removable and the shoe or bracket may be substituted when firing on scotches or using the firing platform.

The *elevating and traversing* gears are operated by handwheels on the left side of the carriage. The Mark VI carriage permits of an elevation of 50°; the Mark VII, 45°; and the Mark VIII-A, 38°. Both carriages permit a traverse of 8°.

A *quick-loading gear* is provided to allow the gun to be brought rapidly to loading position when firing at high angles of elevation.

The *wheels* are of the all steel wide-tire type, 66 inches in diameter with tires 12 inches wide. They are fitted with brakes which act independently on each wheel.

Sighting is accomplished by means of a rocking-bar sight supplemented by a panoramic sight. These are located on the left side of the piece and serve to lay for elevation and traverse respectively. A dial sight is provided on the right side of the piece for quick laying.

Ammunition of the separate loading type is used with the 8-inch howitzer. Shell issued is of the high-explosive type only and weighs 200 pounds. These are issued filled but not fuzed and are fitted with a booster and adapter. Fuzes of types to suit different conditions of firing are provided, giving delayed or instantaneous action.

The propelling charge is contained in cloth bags and is made up of separable increments, permitting various zones of fire. The maximum charge for the Mark VI howitzer weighs 10.8 pounds; for the Mark VIII½ howitzer, 17.5 pounds.

Separate loading ammunition is used in the 6-inch gun mounted on a Mark VIII-A carriage. The original British ammunition so closely resembled the American that it was decided to use the regular Mark II high-explosive shell. Each round is issued with the projectile filled, also the adapter and booster in place. The fuze hole in the adapter is fitted with a white metal plug. The weight of the projectile complete is 90.33 pounds. The propellant charge will consist of a base section and increment section having a total weight of approximately 25 pounds.

8-INCH HOWITZER CARRIAGE LIMBER, MODEL OF 1917 (VICKERS).

The limber provided with this and for the 6-inch gun matériel is of steel construction and provides a chest for tools and spares, also seats for the personnel. No ammunition is carried in this limber, but two types of poles are provided, a long one for horse-drawn vehicles and a shorter connecting pole for motor traction.

The box or chest of limbers manufactured in England is of wood and is bolted to the top of the rails. The lid is covered with water-proofed canvas and hinged at the front. Those limbers which were manufactured in the United States are provided with steel chests which vary slightly from the wooden chests in fittings provided for tools and accessories.

The axle is cylindrical in shape and fitted with special axle arms. It passes through bearings formed in the rails and is held in position by brackets.

The top of the chest is equipped with guard irons and blanket straps, receptacles being provided on the sides and ends to take an ax, a shovel, and other implements. The interior of the chest is fitted to carry tools, spare packings for buffer and recuperator, and other necessary stores. Clips are secured at the front of the chest to accommodate two rifles, used in emergencies when attacked en route.

The wheels are 66 inches in diameter and have a tire 6 inches in width with rounded edges.

Weights and dimensions.

Length of wheel base, limber, and carriage (limbered).....	inches..	187
Overall length of limber, carriage, and firing platform wagon (tractor draft).....	inches..	550
Turning angle.....	degrees..	40
Weight of limber, empty.....	pounds..	2,160
Weight of limber, fully equipped and loaded.....	do....	2,600
Diameter of wheels.....	inches..	66
Width of tires.....	do....	6
Width of track.....	do....	82
Weight of each wheel.....	pounds..	554
Number of men carried.....	3

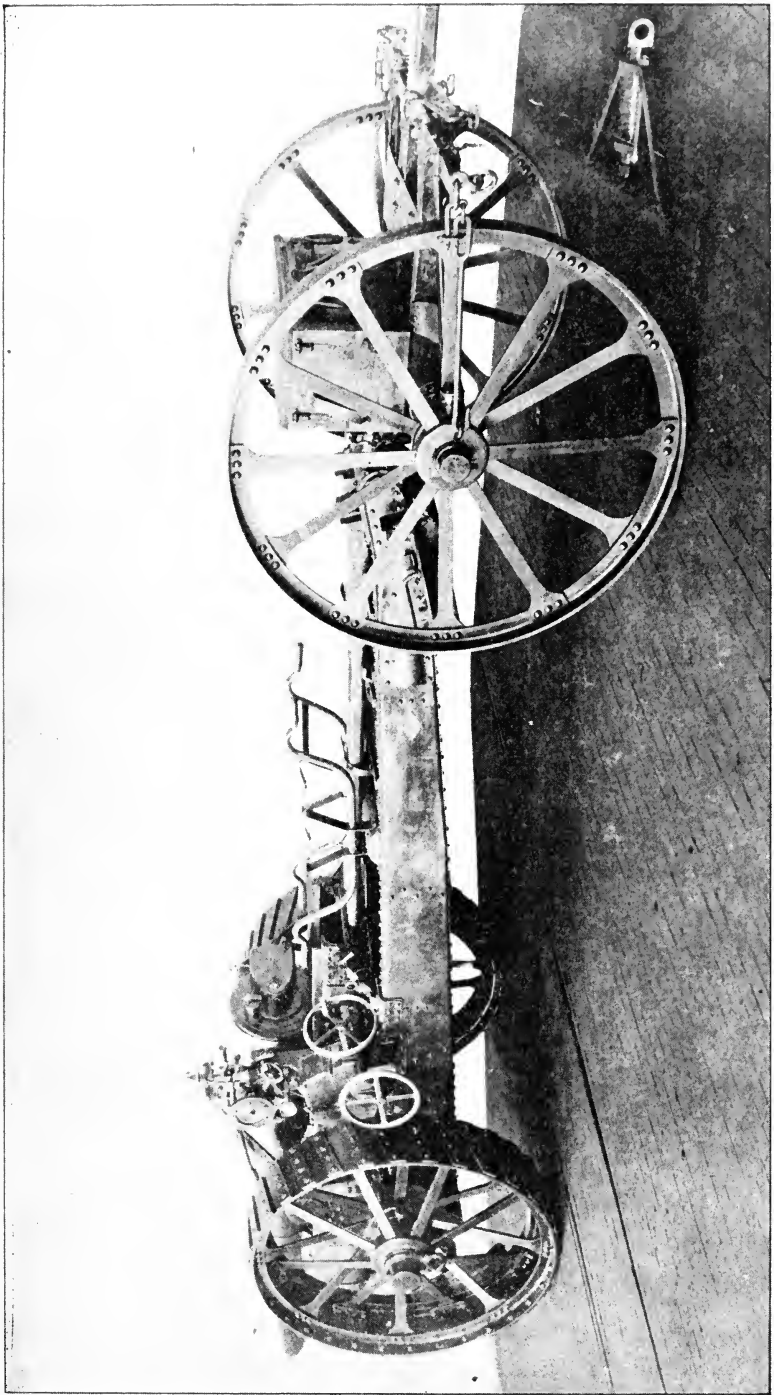

8-INCH HOWITZER CARRIAGE LIMBER, MODEL OF 1917 (VICKERS).

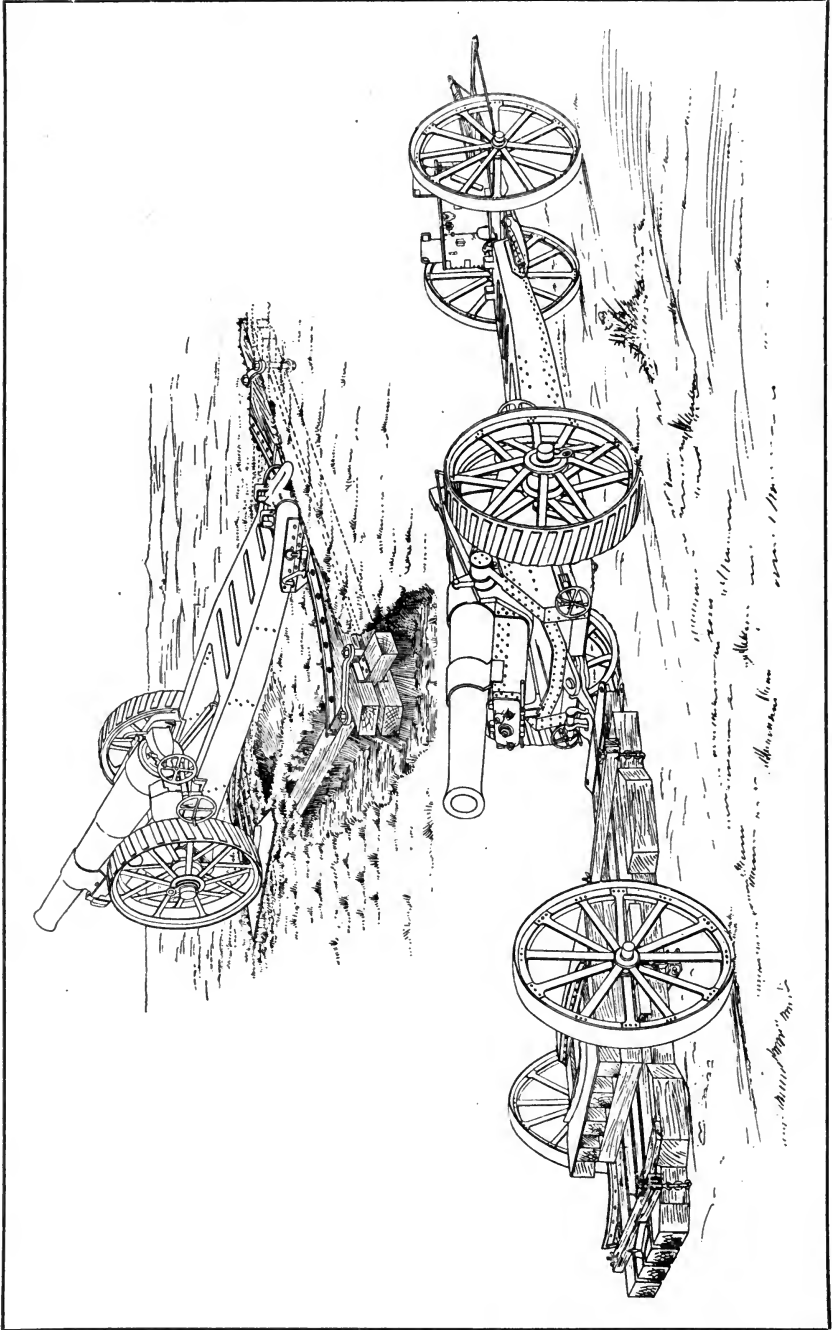

8-INCH HOWITZER MATÉRIEL EN TRAIN AND IN BATTERY.

8-INCH HOWITZER FIRING PLATFORM AND WAGON, MODEL OF 1917 (VICKERS).

A wooden firing platform is provided on which the carriage of the 8-inch howitzer and 6-inch gun matériel can be mounted when sufficient time is permitted for setting up. The platform consists of wooden beams which assemble to form a triangular platform. The spade must be removed and a special bracket fitted on the trail when using this platform. This bracket travels in a groove which gives a bearing for the bracket and also provides a means of traversing the piece 52° on the platform. The platform is disassembled and mounted on a pair of wheels and axle for transportation.

The main objects in the use of the firing platform are: To provide a reliable support for the wheels and rear end of the trail, so as to prevent sinking or movement when firing on soft ground; to insure the gun remaining on the target when firing; and to provide means for shifting the trail transversely through an angle of 52° (26° each side of center). By using the traversing gear on the carriage a total traverse of 30° on each side of the center is obtainable.

The firing platform is composed of a support upon which the wheels of the carriage rest, two side beams hinged together at the forward end and a rear beam made in a top and bottom section. These components form a triangular-shaped frame upon which the carriage may be placed when firing.

The support for the carriage wheels is placed near the apex of the triangle formed by the hinged side and rear beams. The rear beams form the base, the upper one being curved at its front edge to form a guide for shifting the trail. The carriage wheels rest on steel plates on the wheel platform and are guided by curved-steel angles which prevent lateral movement of the gun off the target when in action.

When the firing platform is used, the float plate, with spade attached, which is bolted to the underside of the trail, is removed and another float plate, having a thrust bracket attached, is bolted in its place.

In traveling the units of the 8-inch matériel are arranged in the following order: Limber, carriage, and platform wagon. The usual plan is to draw this combination by a tractor.

Weights and dimensions.

Overall length of wagon (traveling position)	inches..	240
Overall height of wagon.....	do....	66
Overall width of wagon.....	do....	105
Diameter of wheels.....	do....	66
Width of tires.....	do....	6
Width of track.....	do....	85
Road clearance.....	do....	18
Weight of platform.....	pounds..	5,740
Weight of wood platform and wagon (complete).....	do....	7,840
Weight of steel platform and wagon (complete).....	do....	9,630

9.2-INCH HOWITZER MATÉRIEL (VICKERS).

The 9.2-inch and 240-millimeter howitzers are the largest weapons of the mobile type in service by the American Army at the present time. While these calibers are mobile in a sense, yet there are limits to their mobility, for when these howitzers have to be transported over land full of huge craters, with the roads entirely destroyed, the country encumbered with all kinds of débris, and frequently reduced to a sea of mud, one can realize just why a successful attack usually nets captured artillery, and on the other hand, if the trenches give way, it is rather difficult to get these heavy howitzers away quickly enough to save them from being captured by the enemy.

Both types of 9.2-inch howitzers are practically similar in all features, both being platform mounts as illustrated. These units break up into three separate loads for traveling, the howitzer proper forming one load, the top carriage and cradle the second load, and the platform the third load.

The Mark I type of howitzer is 13 calibers long, while the Mark II type is 17.3 calibers, the principal difference being that the latter model is a more powerful weapon. Both types are provided with an earth box which is secured on firing beams, and in which the earth excavated for the firing beams is thrown; the additional weight gives greater stability when firing.

The recoil mechanism is of the variable type which limits the amount of recoil according to the elevation, the recoil cylinder being fitted with a counterrecoil buffer to control the return of the howitzer into battery. A gravity tank insures that the recoil cylinder will at all times be filled with oil, but will provide the proper amount of void for expansion of the oil in the cylinder.

The counterrecoil mechanism is of the pneumatic type consisting of a cylinder, a piston with rod, and a floating piston. The floating piston separates the oil and air chamber and the rod extending through the oil chamber provides a differential pressure and effects a seal, preventing the air leaking into the oil chamber.

The operation of the howitzer in firing is that the recoil cylinder and the counterrecoil, or recuperator piston rod, move to the rear with the howitzer, the recoil piston rod and the recuperator cylinder remaining stationary. The flow of oil in the recoil cylinder past the piston rod and valve limits the length of the recoil and the compression of the air in the recuperator cylinder is sufficient to return

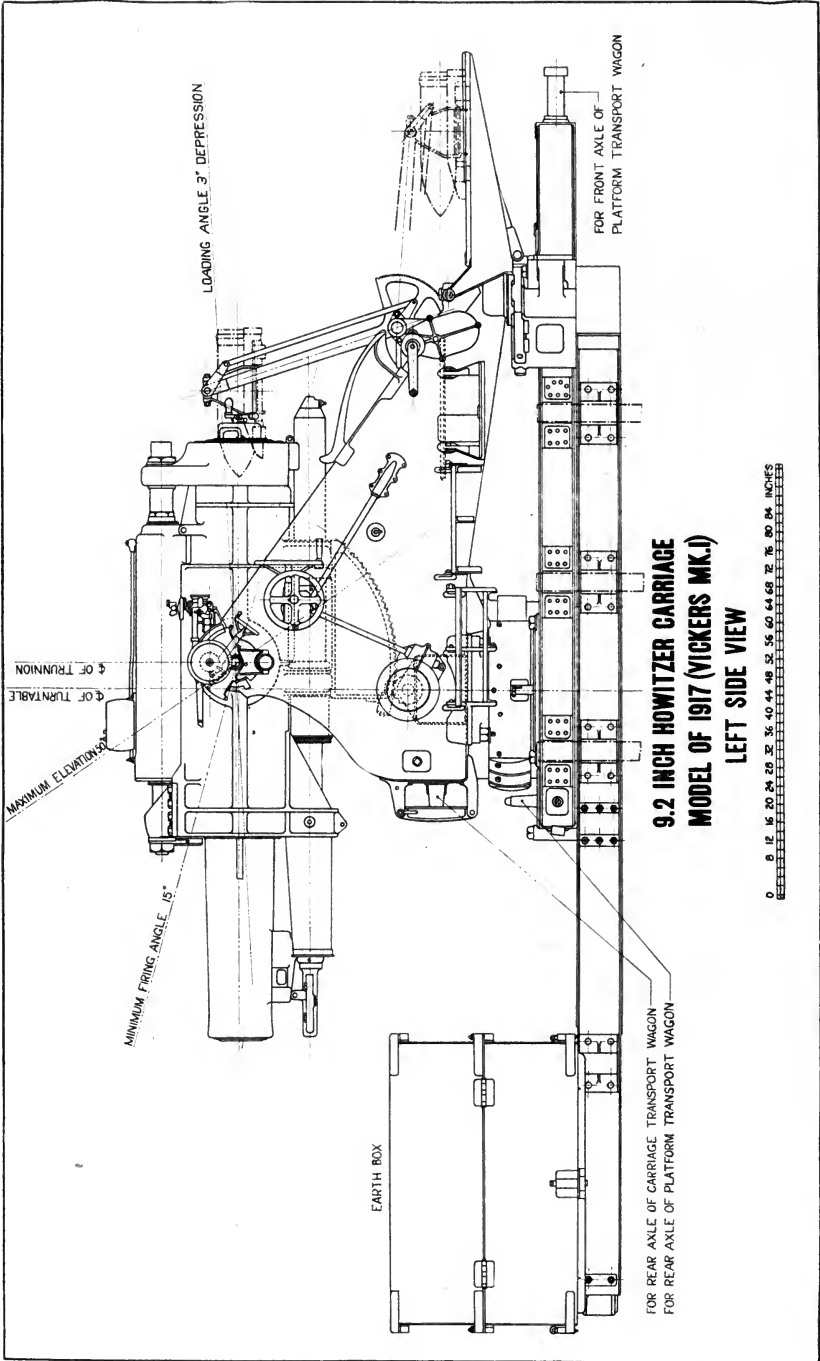

it to battery after the force of the recoil has been absorbed. The counterrecoil buffer in the recoil cylinder limits the counterrecoil of the howitzer and allows the piece to return to battery position without shock.

The howitzer, being comparatively thickset and short when compared with a gun of the same caliber, is capable of greater angle of

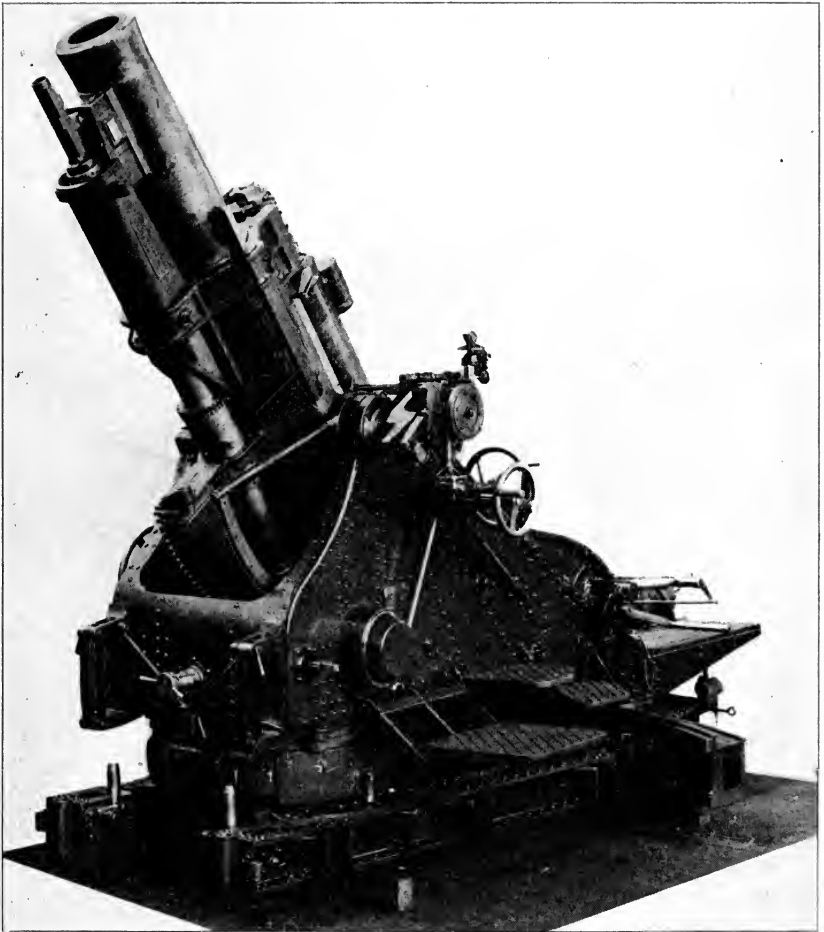

FRONT VIEW SHOWING MAXIMUM ELEVATION OF HOWITZER.

elevation than the same caliber of gun. The gun is primarily intended for attacking troops while the chief aim of the howitzer is to destroy incumbrance such as trenches, barbed wire, pill boxes, and the like. A shell that travels from the howitzer ascends at a high angle and drops almost vertically. The explosion of a shell so fired is much more effective than one that is fired with only a slight elevated trajectory as in the case of the field gun of the same caliber.

From information based on actual experience, the 9.2-inch howitzer, Mark I type (low velocity), has an average life of 8,300 rounds, while the Mark II (high velocity) has an average life of 3,500 rounds.

The howitzer transport wagon is a four-wheeled vehicle the body of which contains a winch for removing and mounting the howitzer in the cradle. This vehicle is equipped for motor traction and has brakes acting individually on each hind wheel.

The carriage bed (or platform) transport wagon is formed by fixing a front and rear axle to suitable attachments on the bed, thus forming the body of the wagon. Attachments are provided for brakes which act independently on each hind wheel and connections for attachment behind the howitzer transport wagon.

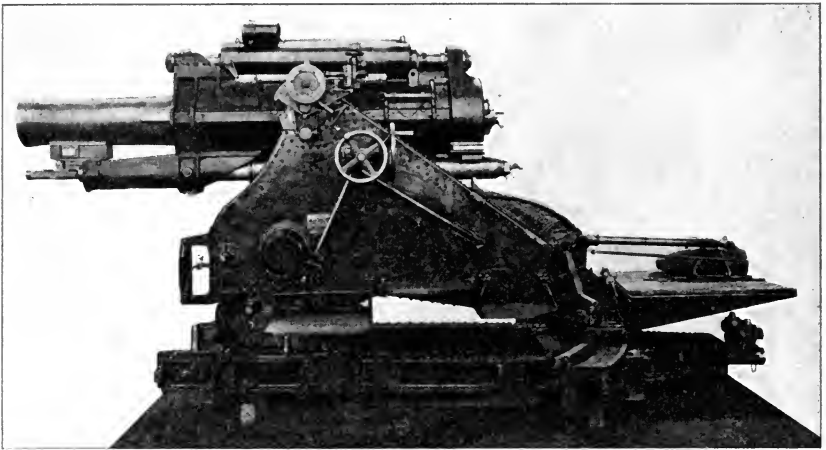

LOADING POSITION OF HOWITZER, SHOWING SHELL ON TRAY.

The top carriage transport wagon is formed by attaching two axles with wheels to the top carriage, which forms the body. Individual brakes are fitted on the hind wheels. This vehicle is usually coupled behind the platform wagon.

The three wagons are drawn en train by tractor but may be hauled singly in case of necessity.

The 9.2-inch howitzer matériel (Vickers), Mark I, consists of:

- Howitzer carriage, model of 1917.
- Howitzer platform transport wagon, model of 1917.
- Howitzer carriage transport wagon, model of 1917.
- Howitzer transport wagon, model of 1917.

The 9.2-inch howitzer matériel (Vickers), Mark II, consists of:

- Howitzer carriage, model of 1918.
- Howitzer platform transport wagon, model of 1918.
- Howitzer carriage transport wagon, model of 1918.
- Howitzer transport wagon, model of 1918.

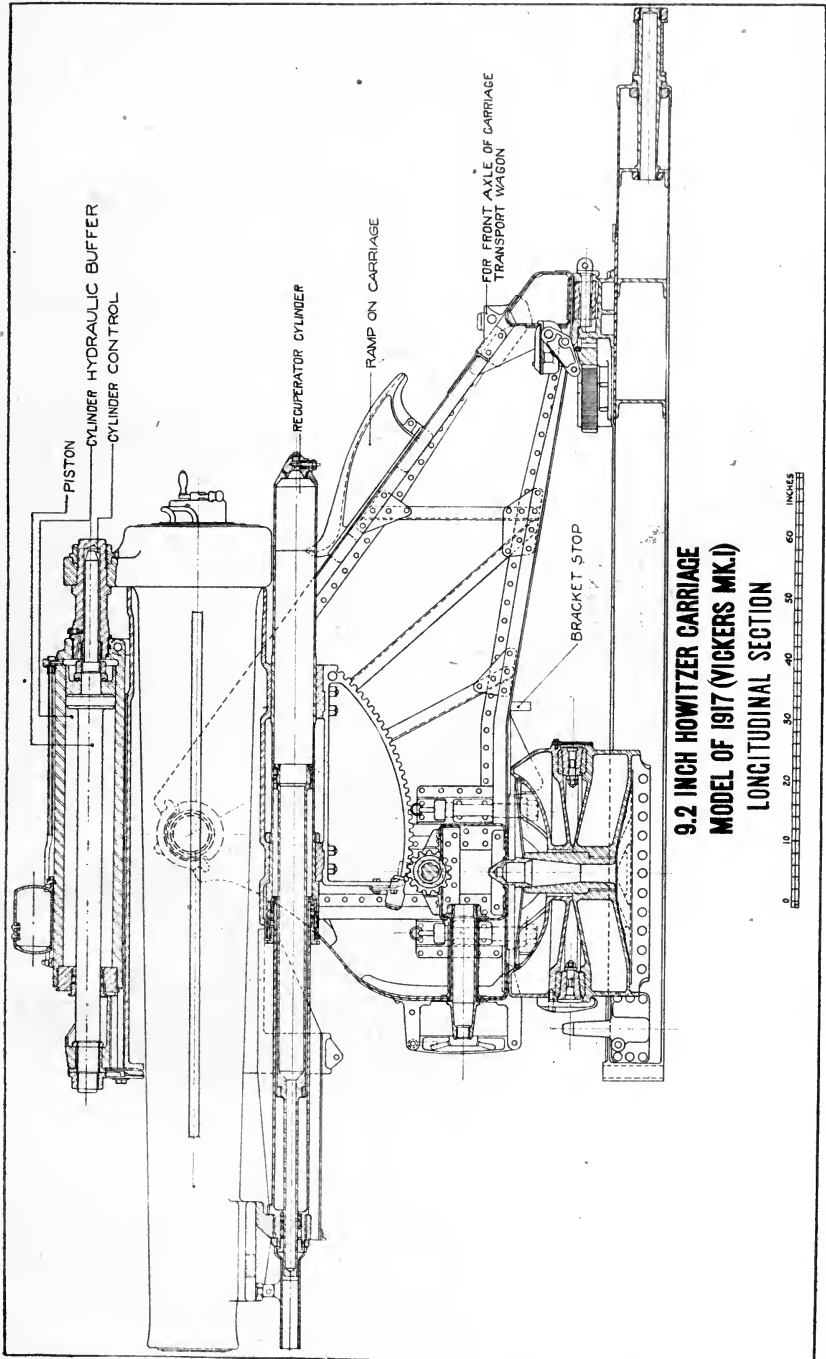

**9.2 INCH HOWITZER CARRIAGE
MODEL OF 1917 (VICKERS MK.I)
LONGITUDINAL SECTION**



CLASS 36 DIVISION 3 DRAWING 148

9.2-INCH HOWITZERS AND CARRIAGES, MARKS I AND II (BRITISH).

This matériel is designed to be transported in separate loads, thus three four-wheeled vehicles are issued for this purpose. The first carries the howitzer, the second the carriage, and the third the platform and earth box, all of which is of British design, but the United States is in possession of equipment made both in this country and Great Britain.

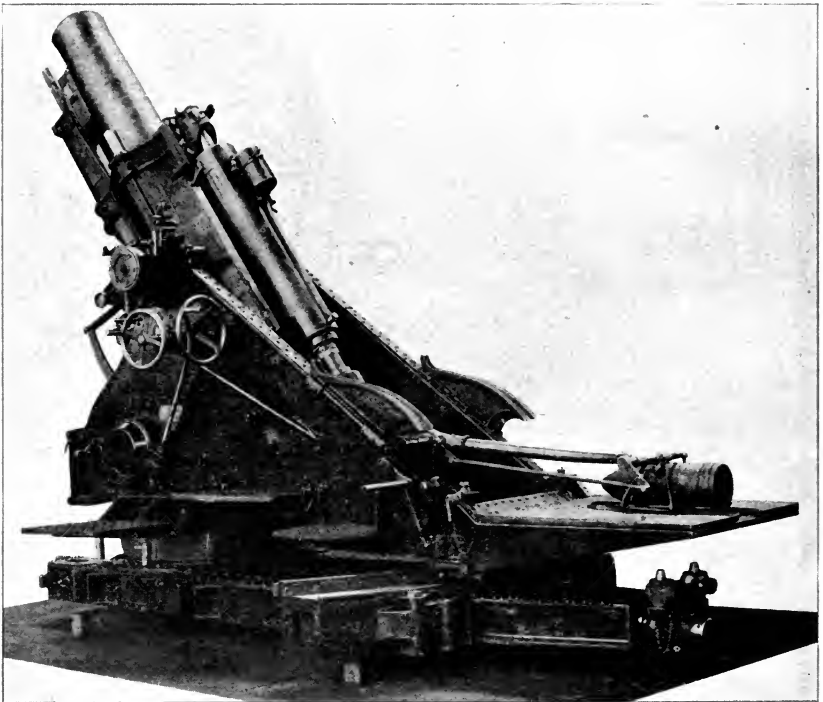

REAR VIEW OF CARRIAGE, SHOWING HOWITZER AT MAXIMUM ELEVATION.

The *howitzer* consists of a tube, muzzle stop ring, a series of layers of steel wire, jacket, breech bushing, and breech ring. Over the exterior of the tube is wound a series of layers of steel wire extending from the breech end to the stop ring, which is shrunk over the tube at the muzzle. Over the exterior of the tube is shrunk the jacket, which is secured longitudinally by the breech bushing. The bushing is prepared for the reception of the breechblock. The breech ring is screwed and shrunk over the jacket at the rear.

The Mark II differs in that it has two tubes shrunk one over the other on which the wire is wound. The Mark I howitzer is 133½ inches in length, while the Mark II is 170½ inches.

The *breech mechanism* of the screw type with plastic obturator is so arranged that by partially revolving the operating lever the breech-block is unlocked and the block with the gas-check pads and disks withdrawn from the seating in the chamber. The breech mechanism can then be swung into the loading position by means of a handle on the rear face of the breechblock. The breech is closed by a parallel screw having five portions of the screw thread removed longitudinally, each one-tenth of the circumference. The main characteristics of the Vickers 9.2-inch howitzers are indicated in the accompanying table, giving the important dimensions, weights, and ballistics.

The Mark I breech requires two operations to open. A handle turning on the rear of the block revolves and releases the block, then

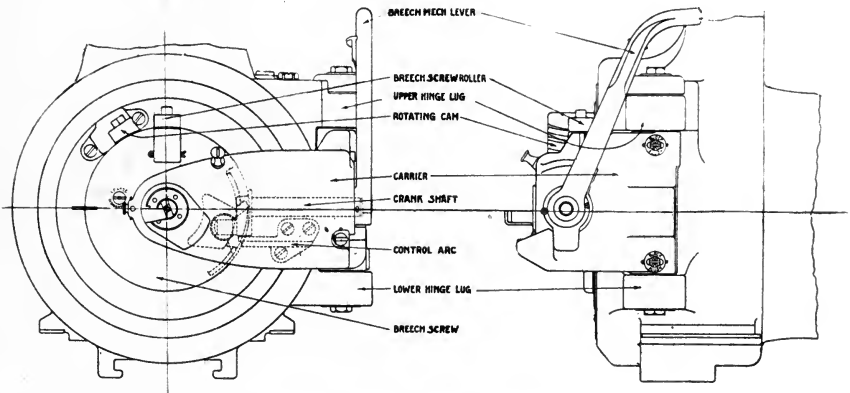

BREECH MECHANISM (MARK I).

it must be swung open by the handle provided on the breech. The Mark II breech can be opened by one motion of a lever on the right side of the breech, which revolves and withdraws the breech in one motion from front to back.

Both types are fitted with a firing mechanism to accommodate the T-tube primer. Later models are fitted with the French percussion type of firing mechanism described with the 155-millimeter howitzer matériel on page 216.

The *recoil mechanism* is of the hydropneumatic type and is equipped with a variable recoil, which shortens the length of recoil after 15° elevation.

The recoil cylinder is located above the howitzer, the former being secured to the howitzer and moves with it, while the piston rod is secured to the cradle. The recoil is controlled by passage of oil through ports in the cylinder, which are varied by the valve located

near the piston on the rod. This valve is rotated by lugs which engage spiral grooves in the cylinder. A mixture of glycerine and oil is used in the cylinder. Later models are fitted with gravity tank on top of the recoil cylinder to replenish the oil and relieve pressure due to expansion. The end of the piston rod is extended and shaped to form a counterrecoil buffer.

The recuperator is located below the howitzer; the cylinder being secured to the cradle remains stationary when the howitzer is recoiling; but the ram is secured to the howitzer and moves with it. The oil and air in this cylinder are separated by a floating piston. The ram on recoiling increases the liquid pressure on this piston; this in turn compresses the air, which on expansion will return the howitzer to battery. An initial pressure of 475 pounds per square inch is maintained in the air chamber to hold the piece in battery.

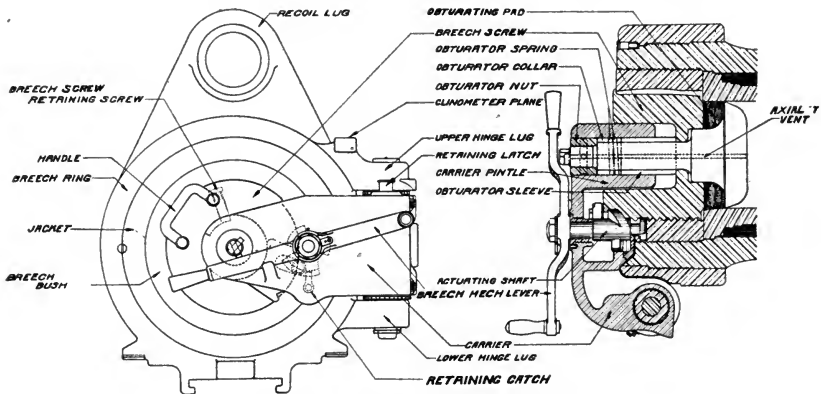

BREACH MECHANISM (MARK II).

To maintain this pressure a pump is attached to the carriage, which can be operated either by hand or a small gasoline engine.

The cradle is a cylindrical chamber formed to house the howitzer. It is provided with trunnions and has the elevating arc secured to its lower side. Grooves cut in the cradle cylinder serve to guide the howitzer during recoil. A toothed arc on the left trunnion operates the valve turning gear through gearing.

The top carriage or body is built up of steel plates. A front transom carries the pivot block, which fits over the pintle on the bed and on which the top carriage pivots. To the rear transom is secured a pinion which, meshes with a rack on the bed, serves to traverse the piece. Suitable platforms are hinged to the body, thus permitting access to working parts and loading platform on the rear for the personnel. On the left rear side of the body is a loading gear, which consists of a swinging arm with a winch and loading tray.

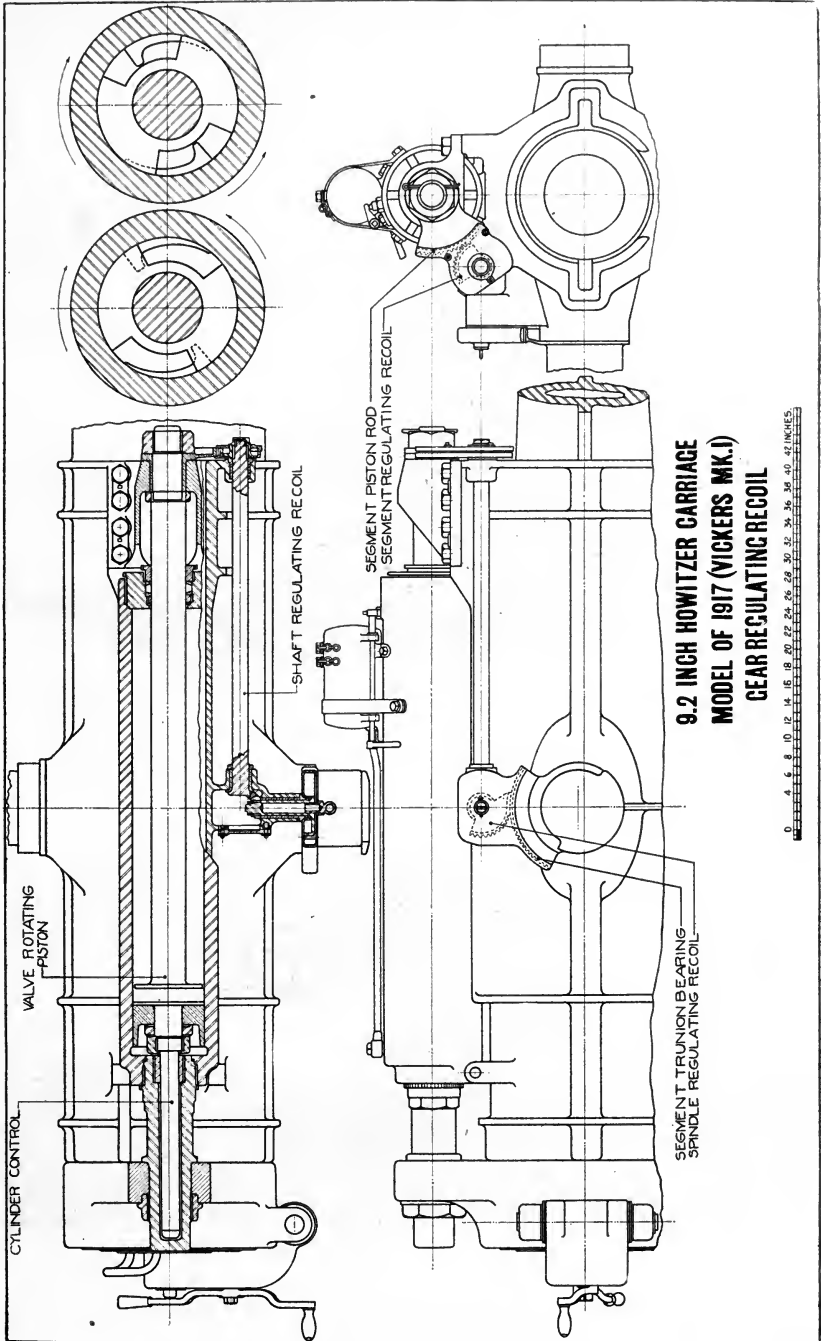

The *traversing gear* is actuated by a handwheel on the left side of the carriage, motion being transmitted to a vertical rack pinion which works in the rack at the rear of the bed; thus a traverse of 30° right and left may be obtained.

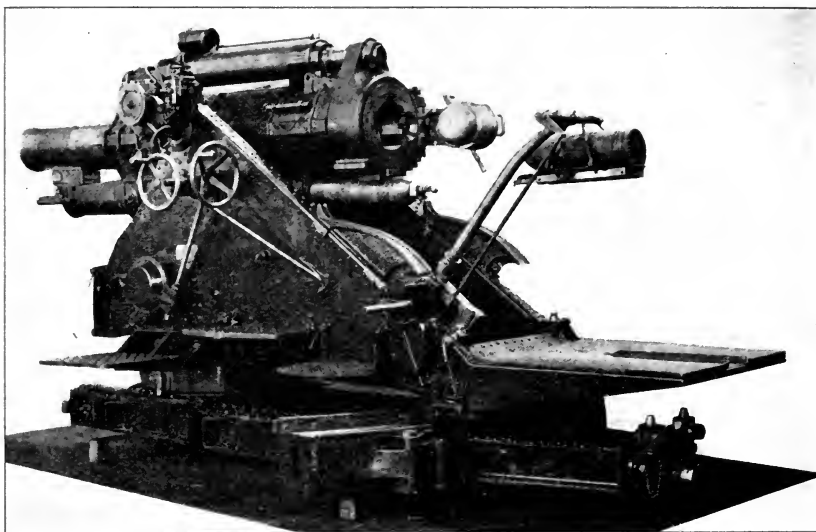

METHOD OF LOADING, SHOWING LOADING GEAR MECHANISM IN ACTION.

The *elevating gear* is operated by a handwheel on the left side of the carriage, which, through a system of gearing, operates the arc beneath the cradle.

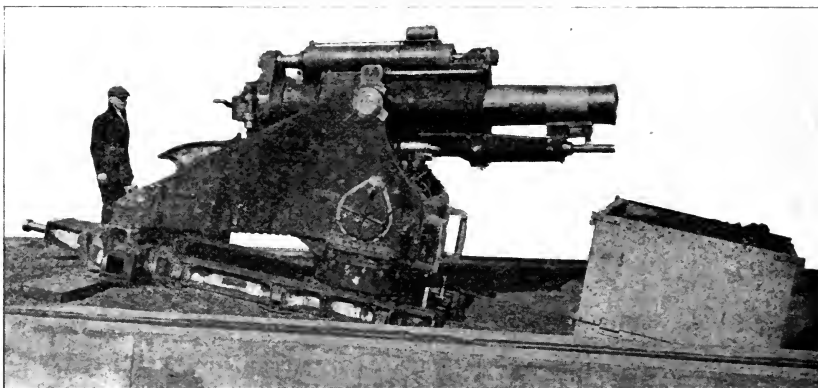

RIGHT SIDE VIEW OF CARRIAGE IN BATTERY.

A quick-loading gear operated by a handwheel on the right of the carriage permits the howitzer to be brought readily to the loading angle, 3° depression. The firing angle ranges from 15° elevation to 55° elevation.

**9.2 INCH HOWITZER CARRIAGE
MODEL OF 1917 (VICKERS MK.I)
TRAVERSING GEAR**

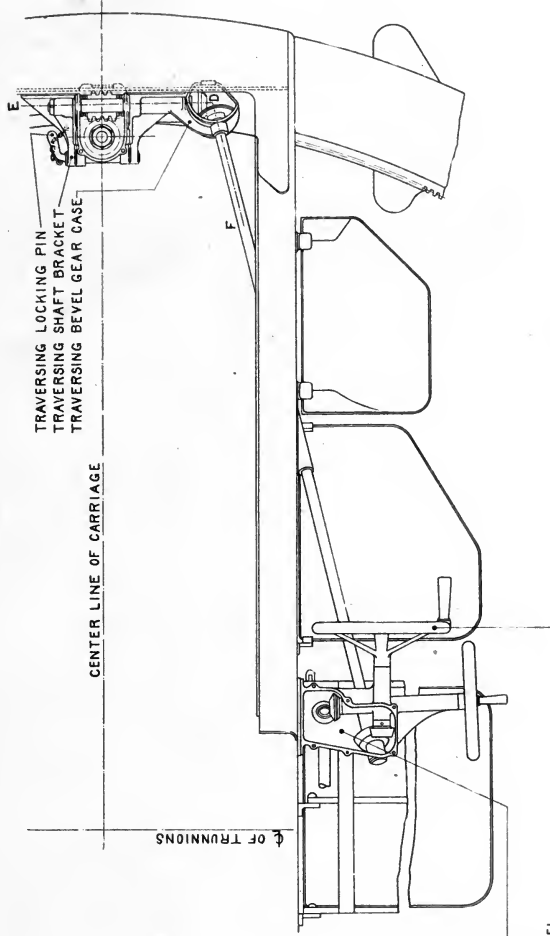

TRAVERSING LOCKING PIN
TRAVERSING SHAFT BRACKET
TRAVERSING BEVEL GEAR CASE

CENTER LINE OF CARRIAGE

LINE OF TRUNNIONS

BRACKET BEVEL WHEELS
ELEVATING AND TRAVERSING
TRAVERSING HANDWHEEL
BEVEL WHEEL
BALL THRUST WASHER
TRAVERSING WORM SHAFT COLLAR
TRAVERSING WORM SHAFT
TRAVERSING WORM

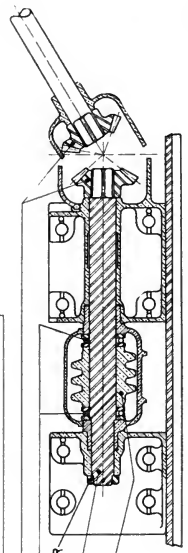

SECTION E-D-E

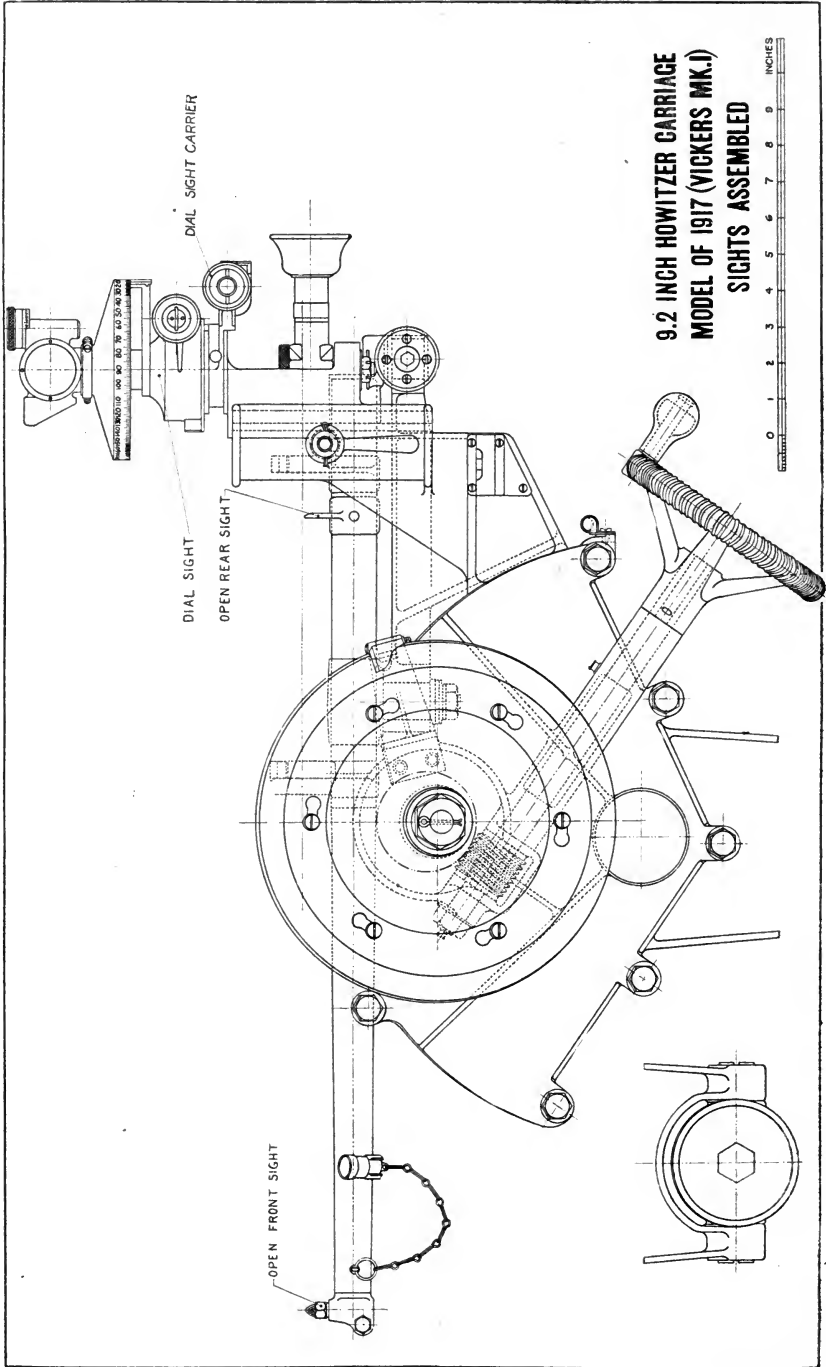

The bed on which the top carriage pivots consists of two steel side guides of box section with transom, a pivot block, and a traversing rack. The bearing of the top carriage is formed by an upper and lower roller path. At the front of the bed are suitable connections for fastening a steel box which is filled with earth to help maintain stability.

Sighting is accomplished by means of a rocking-bar sight, a panoramic sight, or a No. 7 dial sight located on the left of the carriage.

The rocking-bar sight serves to lay for elevation and carries the telescope sight or the dial sight for laying for direction. The dial sight is similar to the United States panoramic sight, which can be substituted.

Ammunition employed is of the separate-loading type. High-explosive steel shell weighing 290 pounds are used, which are fitted with percussion fuses.

The propelling charge is put up in cloth bags, charges being built up with four and with five increments for zone fire are provided. The charge is ignited by the T-tube friction type of primer.

Weights, dimensions, and ballistics.

	Mark I.	Mark II.
Weight of howitzer without breech mechanism..... pounds.....	6,370	8,988
Weight of howitzer with breech mechanism.....do.....	6,800	9,576
Total length of howitzer.....inches.....	133½	170½
Rifling (uniform).		
Powder charge.....pounds.....	13½	27
Weight of shell.....do.....	290	290
Muzzle velocity.....ft. per sec.....	1,187	1,500
Maximum range.....yards.....	10,060	13,080
Weight of mount in firing position complete with howitzer (but without dirt in earth box).....pounds.....	29,100	35,500
Weight of body and cradle.....do.....	10,100	11,200
Weight of bed and earth box.....do.....	8,500	9,100
Weight of earth box empty.....do.....	1,600	2,100
Weight of firing beams.....do.....	4,200	5,700
Weight of ground ramps.....do.....	410	530
Length of recoil at 15° elevation.....inches.....	40	44
Length of recoil at 50° elevation.....do.....	19	19
Maximum angle of elevation.....degrees.....	50	50
Loading angle (depression).....do.....	3	3
Amount of traverse.....do.....	60	60

9.2-INCH HOWITZER TRANSPORT WAGON (VICKERS).

This wagon consists of a front and rear axle and a steel rectangular bed prepared for transporting the howitzer.

The front axle is of forged steel, having an axle arm on each end, to which are fitted 60 by 6-inch steel tired wooden wheels. The steel framework is formed for the reception of the axle and draft pole, and has provisions for the attachment of a tractor.

The bed for transporting the howitzer is prepared on its upper surface to receive the howitzer and is supported at the rear on an axle, each axle arm being provided with a dust excluder and linch pin. When traveling the front end of the howitzer is secured by pawls; the muzzle end being supported by two bronze brackets and

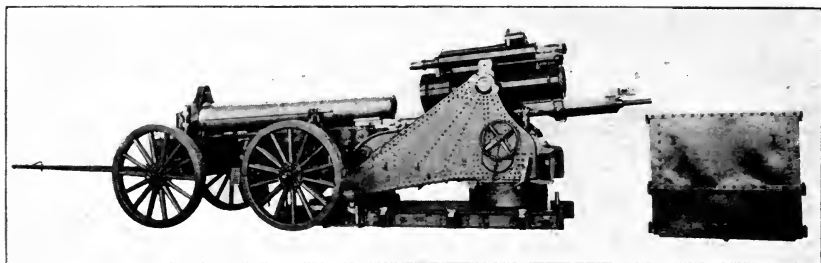

METHOD OF MOUNTING HOWITZER.

secured by a wire rope and draw nuts. The frame is fitted with a draft link in rear for attachment of the draft connector of the next load.

A winch gear for the purpose of shifting the howitzer into, or from, the cradle is provided consisting of an endless chain which, by means of sprocket wheels, imparts motion to a larger endless chain to which the howitzer is connected.

Two rods, one on each side, are secured to a crossbar for connecting the rear of the wagon to the carriage body when mounting or dismounting the howitzer.

The brake gear consists of two brake arms and brake screw fitted with handwheels and two brake blocks. Each side is operated independently by handwheels from the rear. A roller scotch and drag shoe, connected by chains, are attached for use when traveling.

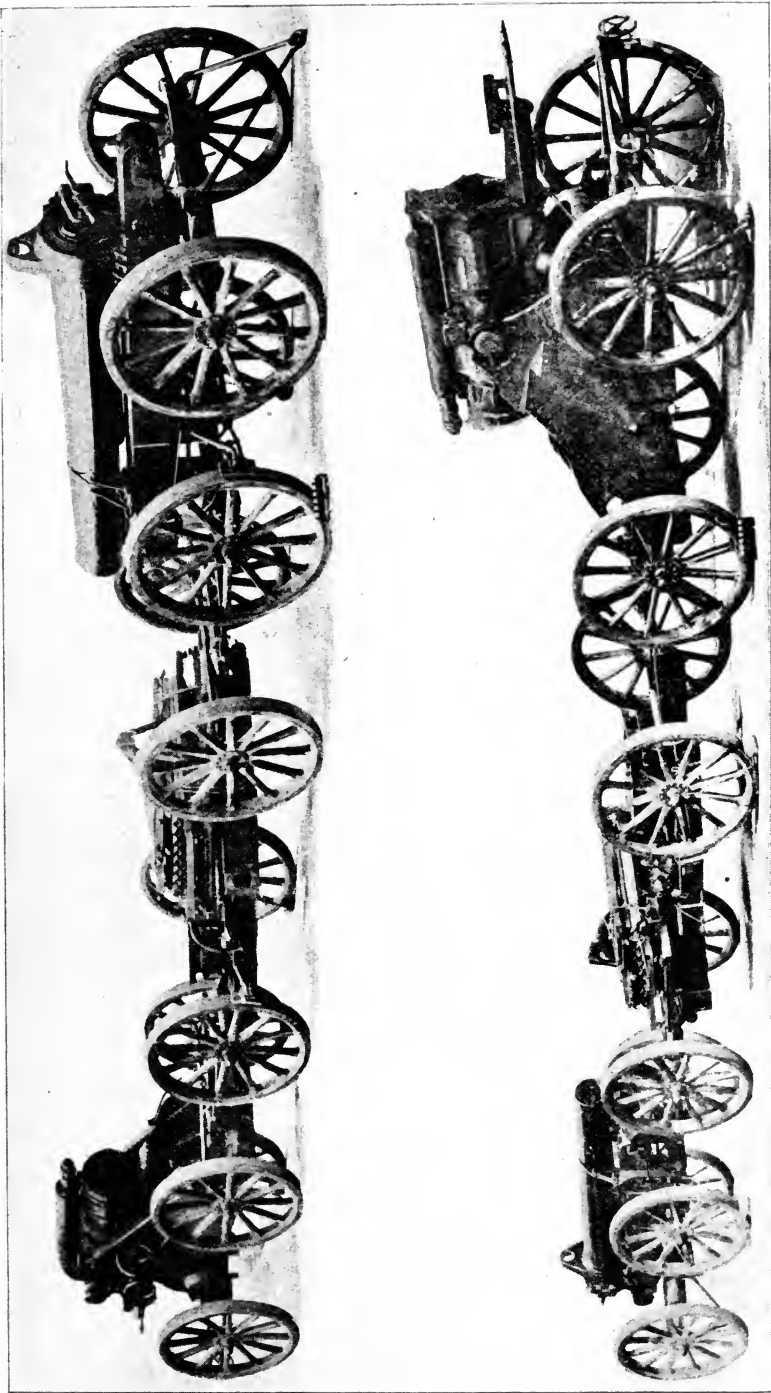

9.2-INCH HOWITZER MATÉRIEL, MODEL OF 1917 (VICKERS), EN TRAIN.

Weights and dimensions.

	Mark I.	Mark II.
Overall height.....inches..	84	86
Overall width.....do.....	96½	109
Weight complete with load.....pounds..	10,600	14,700
Weight complete without load.....do.....	3,900	5,200
Weight on front axle (loaded).....do.....	5,700	6,250
Weight on rear axle (loaded).....do.....	4,900	8,450
Weight of each wheel.....do.....	336	336
Width of track.....inches.....	82	86
Distance between axles.....do.....	88	96
Turning angle.....degrees.....	36	37
Turning circle diameter.....feet.....	33	35

9.2-INCH HOWITZER CARRIAGE TRANSPORT WAGON (VICKERS).

The carriage transport wagon consists of a front and rear axle, cross-bar, brake fittings, draft connection, and four wheels.

The front axle is of forged steel equipped with arms on each end and to which are fitted the wheels. The raising screws for lifting the carriage into position, functions through two vertical holes in the axle.

The draft frame is built up of steel plate and angles; is triangular in shape and formed to take a draft pole fitted with draft hooks for singletrees also joints for a tractor draft connector. The draft pole is the same as that used with the howitzer transport wagon.

The rear axle is of steel, having its arms cranked and fitted with dust excluders, linch pins, and adjusting collars which are secured in position when traveling by the blocks and pivot on the front of the carriage body. These fittings allow of an oscillation which compensates for any unevenness in ground.

Brake levers for each of the brake shoes, on each side of the vehicle, may be applied independently. The mechanism consists of brake screws, handwheels, brake nuts, and bands for connection to the axle.

The roller scotch and drag shoe furnished are the same as those used with howitzer transport wagon.

Weights and dimensions.

	Mark I.	Mark II.
Overall height.....inches..	103½	111
Overall width.....do.....	96½	109
Weight complete with load.....pounds..	12,600	14,800
Weight complete without load.....do.....	2,600	3,600
Weight on front axle (loaded).....do.....	5,000	5,500
Weight on rear axle (loaded).....do.....	7,600	9,300
Weight of each wheel.....do.....	336	336
Width of track.....inches.....	82	86
Distance between axles.....do.....	115	129
Turning angle.....degrees.....	32	{30 right.
Turning circle, diameter.....feet.....	34	{38 left.
		25

9.2-INCH HOWITZER PLATFORM TRANSPORT WAGON (VICKERS).

The howitzer platform-transport wagon in general is very similar to the howitzer carriage-transport wagon. The front axle and draft connections are entirely similar to those on the howitzer carriage-transport wagon, except that only one hole in the center of the axle is provided for the raising screw. When preparing for travel the rear axle, which is fitted with two vertical holes for lifting screws, is attached to rear of the bed. The axle is fitted with dust excluder, linch pins and adjusting collars, and a brake gear which is operated from the rear by handwheels, each side being operated independently. The roller scotch and drag shoe are similar to those used with the howitzer carriage-transport wagon.

Weights and dimensions.

	Mark I.	Mark II.
Overall height.....inches..	65½	60
Overall width.....do.....	96½	109
Weight complete with load.....pounds..	10,000	12,500
Weight complete without load.....do.....	2,700	3,500
Weight on front axle (loaded).....do.....	4,900	5,700
Weight on rear axle (loaded).....do.....	6,000	6,800
Weight of each wheel.....do.....	336	336
Width of track.....inches.....	82	86
Distance between axles.....do.....	160	174
Turning angle.....degrees.....	40	{36 right.
Turning circle, diameter.....feet.....	48	{40 left.
		43

240-MILLIMETER HOWITZER MATÉRIEL, MODEL OF 1918 (SCHNEIDER).

The 240-millimeter howitzer unit, a French design translated to accommodate American manufacturing practice, differs from the smaller type of field artillery pieces in that it is split up into a number of loads for transport. When arranged for firing the carriage is set upon a structural-steel platform which rests in a special prepared pit and has a large trunk portion embedded in the ground to absorb the reaction of the recoiling parts. The platform is stabilized by two hinged floats at the rear.

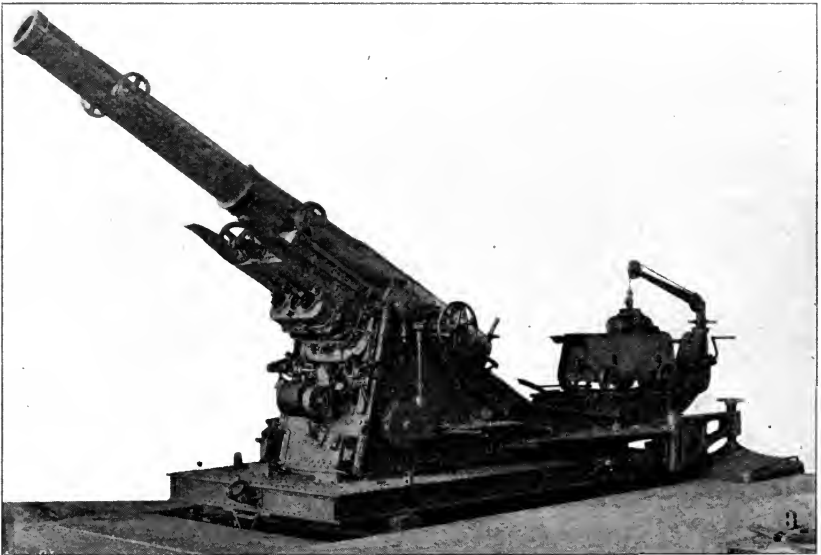

FRONT VIEW OF CARRIAGE, SHOWING MAXIMUM ELEVATION OF HOWITZER.

Although approximately the same size as the British 9.2-inch howitzer (the exact diameter of the bore of the 240 being 9.45 inches) and only a little larger than the 8-inch howitzer, the French gun is by far more powerful than either. The 8-inch and 9.2-inch howitzers have ranges in the neighborhood of 6 miles, their shell weighing 200 and 290 pounds, respectively. On the other hand, the 240 hurls a shell weighing 356 pounds and carrying a bursting charge of 45 to 50 pounds of high explosive, obtaining a range of almost 10 miles. It is estimated that the life of the 240-millimeter howitzer before relining is approximately 5,000 rounds.

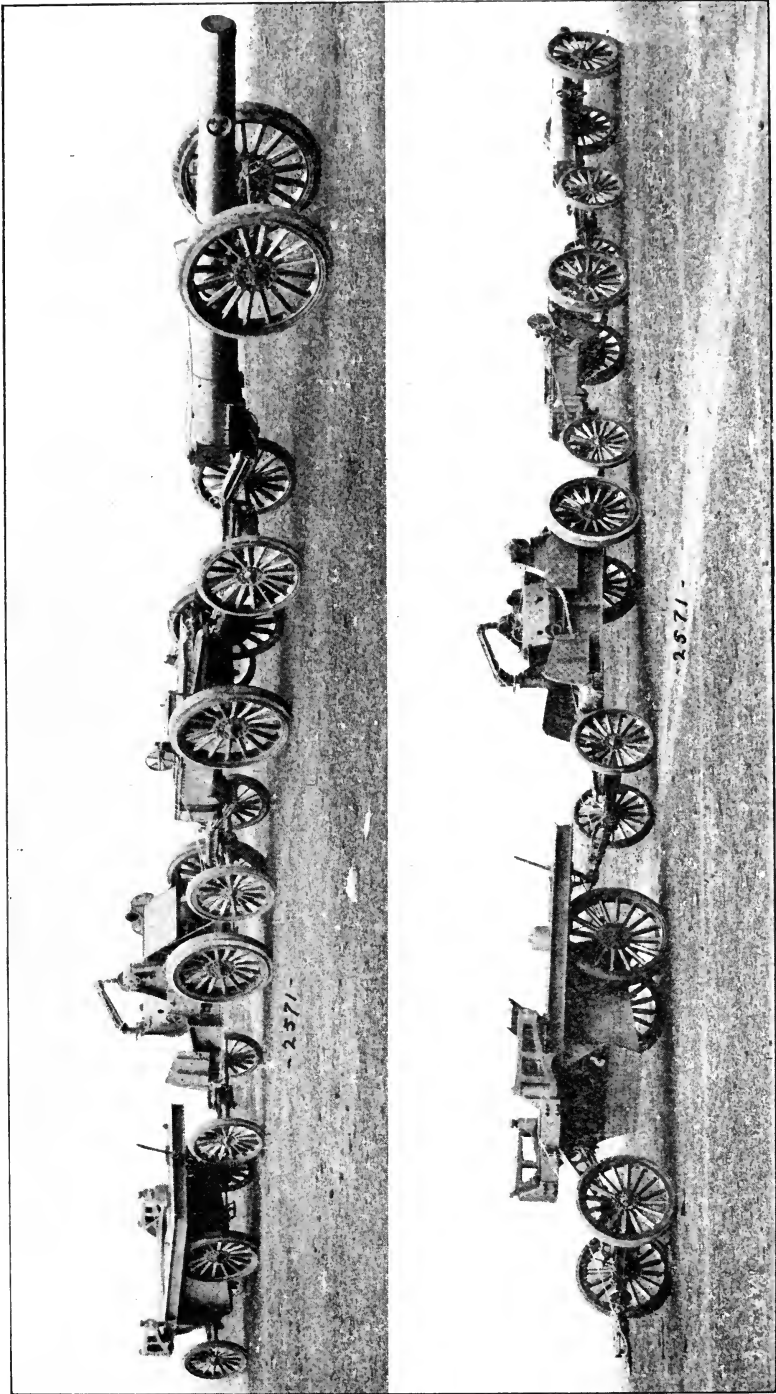

240-MILLIMETER HOWITZER MATÉRIEL, MODEL OF 1918 (SCHNEIDER), EN TRAIN.

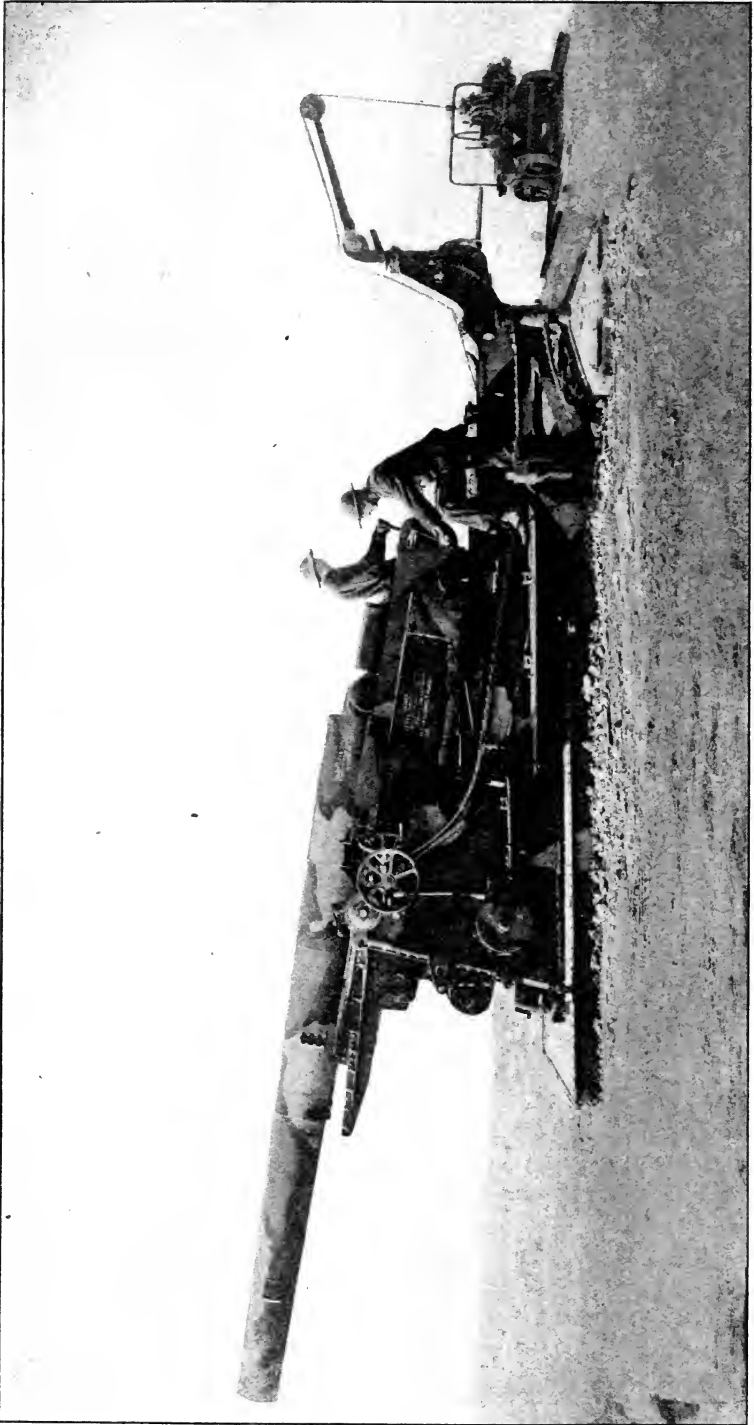

240-MILLIMETER HOWITZER CARRIAGE, MODEL OF 1918 (SCHNEIDER), LEFT SIDE VIEW, LOADING POSITION.

Comparative characteristics of heavy artillery.

	8-inch howitzer carriage.		9.2-inch howitzer carriage.		249-millimeter howitzer carriage.
	Mark VI.	Mark VII.	Mark I.	Mark II.	
Weight of projectile, pounds.....	200	270	290	290	356
Muzzle velocity, feet per second.....	1,370	1,522	1,187	1,500	1,790
Maximum range, yards.....	10,760	12,360	10,060	13,080	17,099
Weight behind tractor heaviest load, pounds.....	29,540	30,490	10,640	13,440	14,000
Number of loads.....	1	1	3	3	4
Weight of carriage and gun in firing position, pounds.....	19,109	20,048	16,240	19,040	37,920
Type of recoil mechanism.....	Hydropneumatic.	Hydropneumatic.	Hydropneumatic.	Hydropneumatic.	Hydropneumatic.
Length of recoil, inches.....	50-24	52-24	40-23	44-19	46.7
Angles of elevation, degrees.....	0-50	0-45	15-50	15-50	-1-60
Total traverse, degrees.....	1 52	1 52	60	60	20

¹ Traverse when firing platform is used; without platform a traverse of 8° is obtainable.

In firing position the howitzer proper interlocks and becomes integral with the sleigh containing the recoil mechanism. A liquid consisting of glycerine and water boiled for 15 minutes is used in the recoil cylinders and a mixture of glycerine, water, and caustic soda is used in the recuperator.

The sleigh has two bronze-lined slideways which engage the clips on the cradle so that the sleigh slides upon the cradle when the howitzer recoils. At the front of the cradle there is attached a cast-steel beam to which the piston rods of the recoil and recuperator cylinders are bolted. The cradle also carries the elevating segments, the firing mechanism, the quick-return mechanism, and a trunnion band which supports the cradle in the trunnion bearings of the top carriage.

The top carriage is composed of two steel flasks united by cross transoms and end plates, and at the rear end carries the brackets which support the loading platform and crane. The top carriage is pivoted at the front on a pintle seat supported by a set of Belleville springs in a pintle socket on the platform. This facilitates traversing the top carriage to its limits of 10 degrees either to the right or left.

The howitzer is served by a shot truck which carries two 356-pound projectiles and runs on an industrial track to and from the ammunition dump. The projectiles are lifted from the shot truck and placed on a rammer car by shot tongs and cable operated by a hand crane, all of which is supported by a loading platform at the rear of the top carriage. The rammer car, operated by hand cranks, moves along a track into the cradle, registering and locking with the breech of the howitzer, after which the projectile is pushed into position by a semiflexible chain, the powder charge being pushed in by hand.

For transportation the complete howitzer unit is divided into four loads, namely, howitzer, cradle, top carriage, and platform. Each

unit is composed of a limber, false trail, and a rear two-wheeled wagon. The tools and accessories for each unit are carried on two 4-ton trailers and the six loads are drawn by caterpillar tractors.

In assembling and dismounting, an erecting device made of structural steel is used for placing the platform and top carriage in position. The cradle and howitzer are drawn into place by a cable and windlass which is attached to the forward part of the top carriage. This erecting device is also used for lifting and placing projectiles on the shot truck from the shell storage.

The howitzer, when elevated to about $43\frac{1}{2}^{\circ}$ and using a propelling charge of 35 pounds, giving a pressure of about 33,000 pounds per square inch on the base of the projectile, will fire a projectile weighing 356 pounds and containing a bursting charge of about 49 pounds of T. N. T. to a distance of approximately 10 miles.

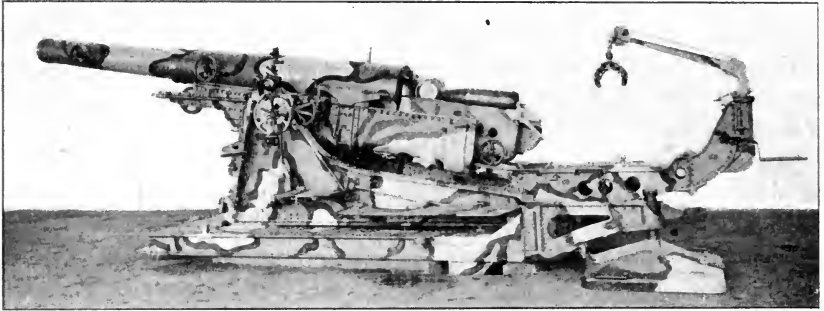

METHOD OF LOADING THE HOWITZER WITH RAMMER CAR.

The following sighting equipment is carried with the 240-millimeter matériel:

- Quadrant sight, model of 1918.
- Panoramic sight, model of 1917.
- Peep sight.
- Sight extension.
- Gunner's quadrant, model of 1918.
- Night lighting equipment for sights.

Ammunition of the separate loading type is used with this howitzer, consisting of point-fuzed high-explosive common-steel shell and point-fuzed gas semisteel shell. The shells are issued filled but not fuzed, the fuze hole being closed with a suitable plug. The components of each round are the primer, the propelling charge, the filled projectile, and the fuzes.

To transport the complete carriage, there are provided four transport vehicles—howitzer transport wagon, top carriage transport wagon, platform transport wagon, and cradle transport wagon.

**240 MM. HOWITZER, MODEL OF 1918 (SCHNEIDER).
LEFT ELEVATION**

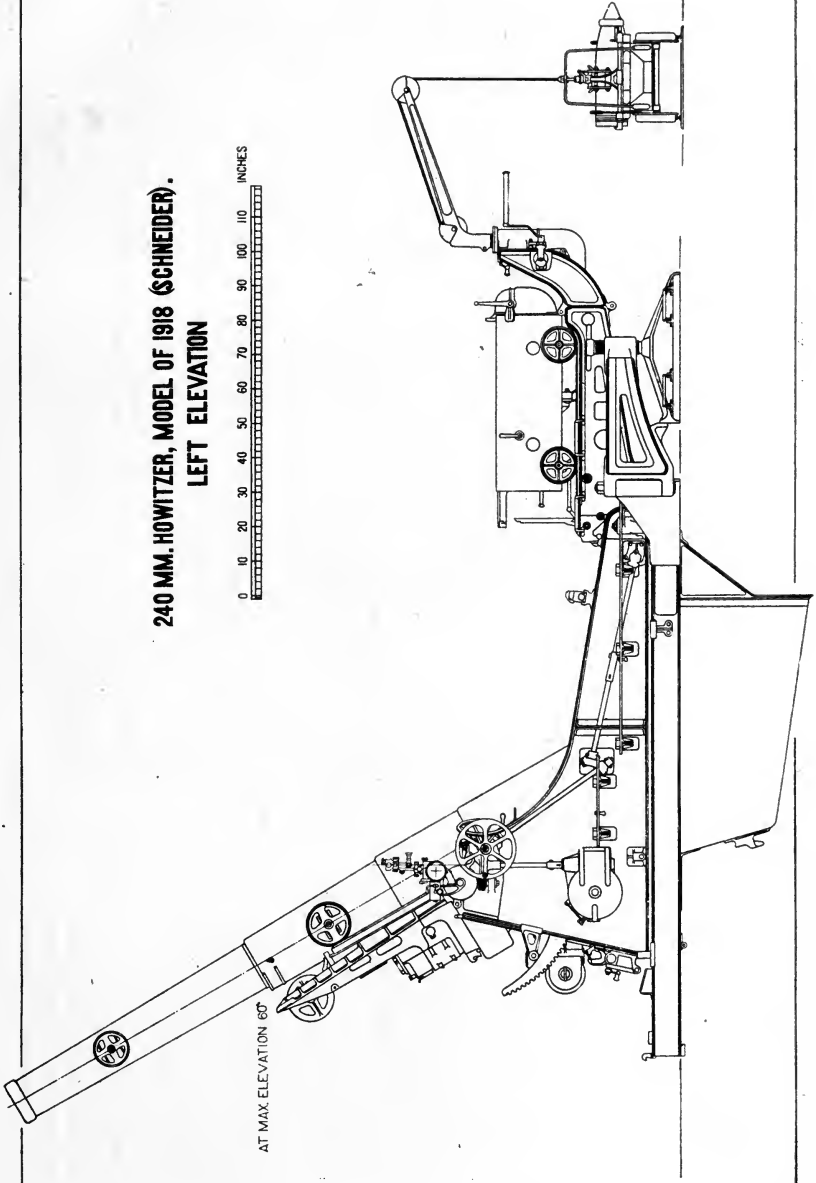
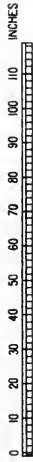

AT MAX ELEVATION 60°

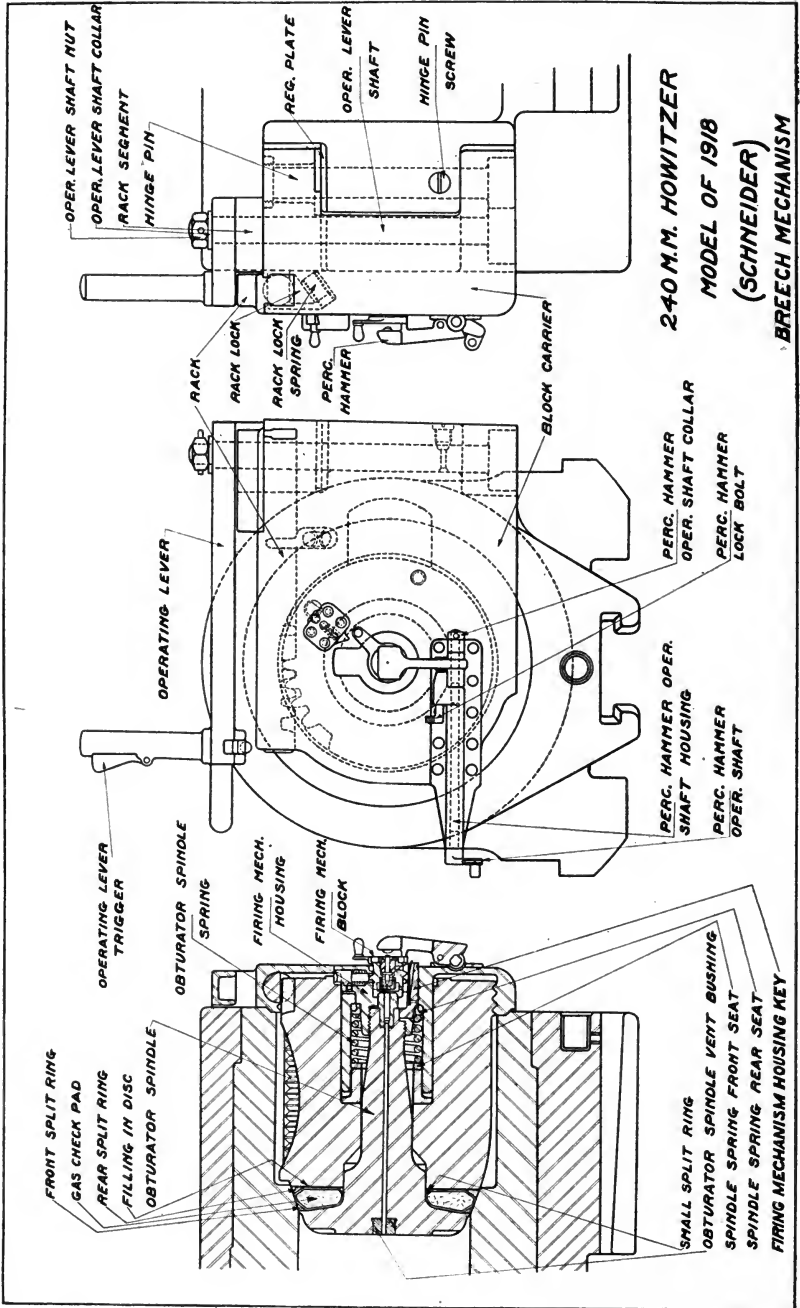

Each transport vehicle consists principally of a limber, false trail, and rear axle and wheels.

The limber consists of wheels, axle, pole, and turning arc and is similar for each wagon. It is equipped with a pintle, over which fits the lunette ring of the false trail. The turning arc is attached to the axle, and the false trail bears on it as it rotates around the pintle.

Four false trails are provided, one for each wagon. They are fitted at the front end with a lunette ring and at the rear with a locking arrangement for attachment to the unit to be transported.

The rear axles are provided with suitable means for attachment to their respective units, and band brakes are fitted on all the rear axles.

When the complete carriage is set up for firing, the transport vehicles are close coupled by means of the false trail and form short units, having four wheels, which can be drawn away. All wheels are equipped with solid rubber tires.

240-millimeter howitzer matériel, model of 1918 (Schneider), consists of:

Howitzer and carriage, model of 1918.

Howitzer carriage limber, model of 1918.

Howitzer transport wagon, model of 1918.

Howitzer cradle transport wagon, model of 1918.

Howitzer top carriage transport wagon, model of 1918.

Howitzer platform transport wagon, model of 1918.

The above matériel is of French design, but was manufactured only in the United States.

240-MILLIMETER HOWITZER AND CARRIAGE, MODEL OF 1918 (SCHNEIDER).

The howitzer is built up of alloy steel and consists of a tube, a jacket, and hoop. The jacket is shrunk on the rear end of the tube and is secured from slippage by threads cut in its inner surface, which screw over corresponding threads on the tube, the rear end of which is prepared for the reception of the breechblock. The hoop is shrunk and screwed on the tube forward of the jacket, which is fitted at its rear end with a hinge lug, vertical clips for joining the howitzer to the sleigh, and guide bosses for joining the sleigh to the howitzer; also a T slot to suit the false trail when entrain. At the front end of the hoop is a boss to accommodate the axles of the transport wagon and lugs for rollers used in the dismounting and mounting of the howitzer.

The breech mechanism is of the interrupted-screw type and is fitted with a plastic obturator. One motion of the breech lever swinging from left to right turns and swings the breech clear.

The firing mechanism is of the French percussion type, the same as used on the 155-millimeter howitzer, and is interchangeable with the mechanism of the following matériel:

155-millimeter gun, model of 1918 (Filloux).

155-millimeter howitzer, model of 1918 (Schneider).

8-inch howitzer, Marks VI and VIII $\frac{1}{2}$ (Vickers).

The sleigh, a steel forging, is bored out to house the recoil mechanism and supports the howitzer, being attached to it by lugs and locking clips, and therefore recoils with the howitzer when in action. Grooves in the sleigh house guides fastened to the cradle which serve to guide the howitzer in recoil. The sleigh is also fitted with two tracks for the rollers on the howitzer, which are used in mounting and dismounting.

The cradle carries the trunnions and is a nonrecoiling part. The recuperator piston rod and the recoil piston rods being attached to it.

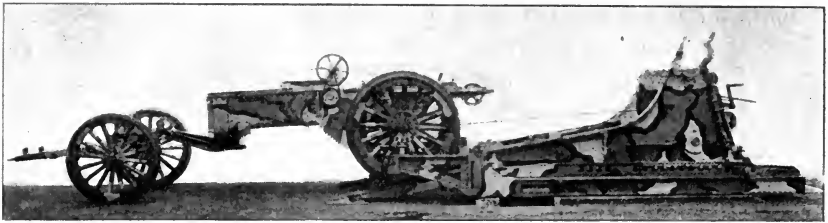

MOUNTING THE CRADLE.

The recoil mechanism is of the hydropneumatic, long-recoil type, the length of recoil being constant for all elevations. In the sleigh forging are bored five longitudinal cylinders, the upper two being bored about half the length of the sleigh and are closed at the front end by caps, forming air reservoirs. The left reservoir has an opening in which the pressure gage is fitted to test the pressure of air or gas.

The lower cylinders extend the full length of the sleigh, while the two outer cylinders form the recoil and the middle the recuperator cylinder. The recuperator cylinder is connected by passages to the two air chambers, permitting the liquid from the recuperator to flow into them.

The recoil piston rods are hollow and are fixed rigidly to the cradle. In the hollow space travel the throttling rods, which move with the recoiling parts. These rods are so shaped that they give a throttling effect on the liquid which passes through annular openings around the piston. On return to battery the throttling rods act as a buffer to prevent violent return into battery.

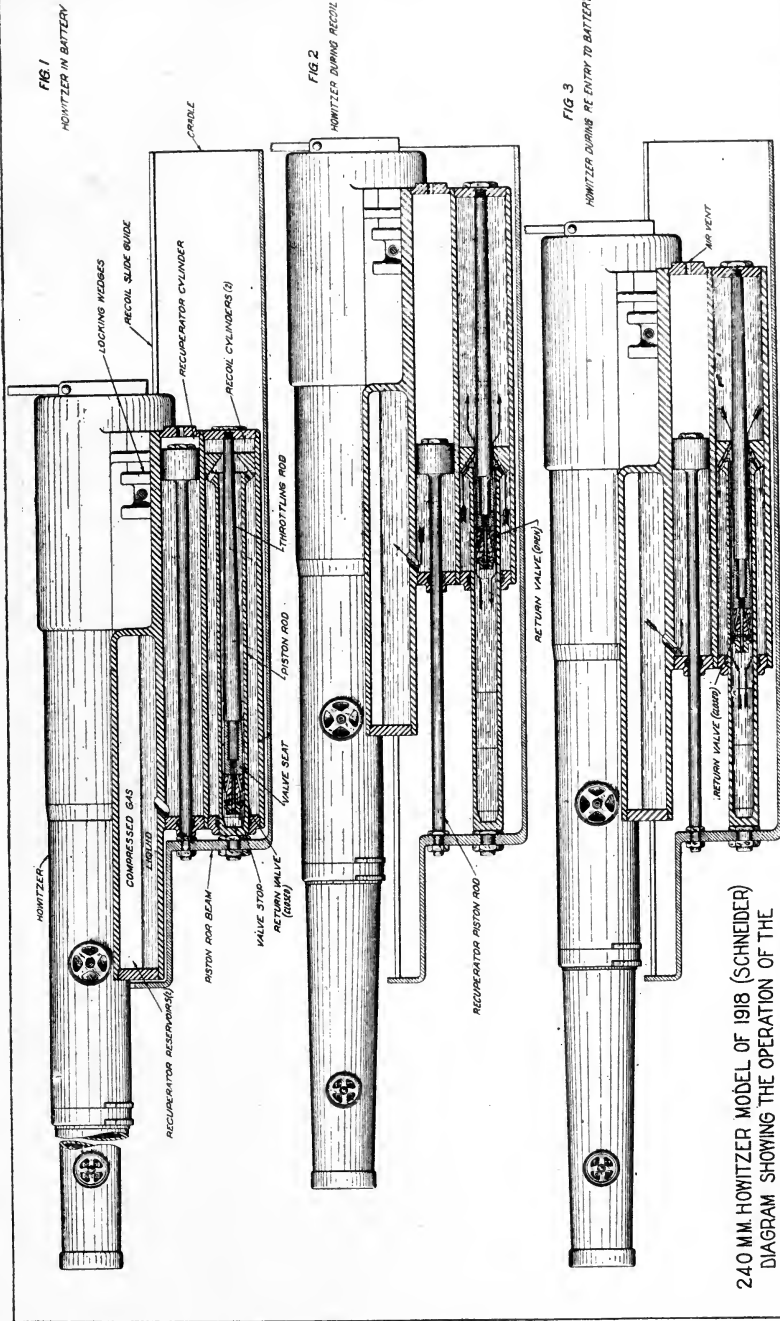

240 MM. HOWITZER MODEL OF 1918 (SCHNEIDER)
 DIAGRAM SHOWING THE OPERATION OF THE
 RECOIL AND RECUPERATOR MECHANISM.

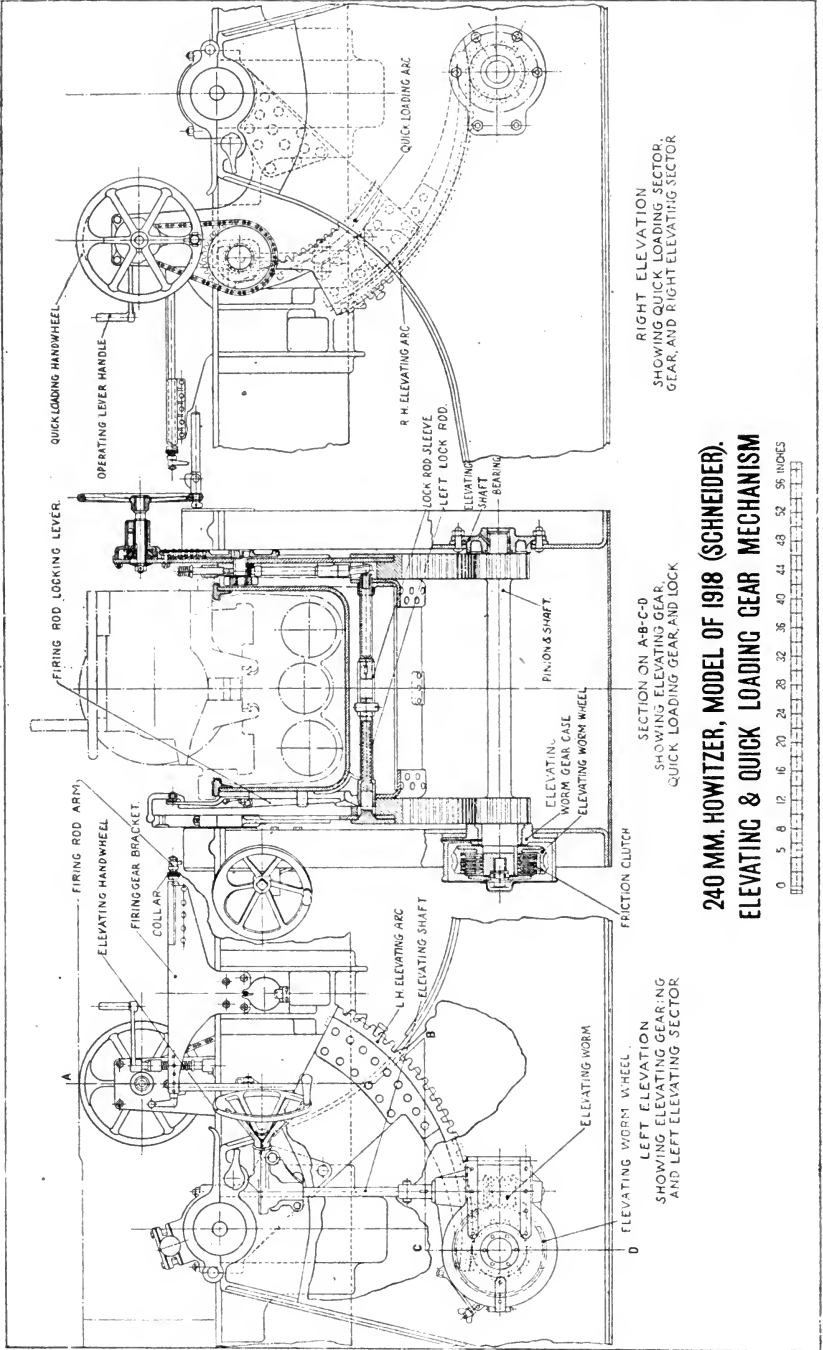

RIGHT ELEVATION
SHOWING QUICK LOADING SECTOR
GEAR, AND RIGHT ELEVATING SECTOR

SECTION ON A-B-C-D
SHOWING ELEVATING GEAR
QUICK LOADING GEAR, AND LOCK

LEFT ELEVATION
SHOWING ELEVATING GEAR, AND
LEFT ELEVATING SECTOR

**240 MM. HOWITZER, MODEL OF 1918 (SCHNEIDER).
ELEVATING & QUICK LOADING GEAR MECHANISM**

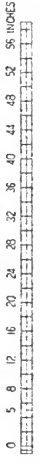

The air (or nitrogen gas) in the recuperator is maintained at a pressure of 568 pounds per square inch, which is sufficient to keep the howitzer in battery at all elevations. Tanks of compressed nitrogen are kept at hand to replenish that in the recuperator in case the pressure gets low. The liquid used in both recuperators and recoil cylinders is a mixture of glycerine and water. Suitable pumps are provided for filling these cylinders.

A *firing handle* is fitted on the left side of the cradle, which, through a system of shafts, operates the percussion hammer on the breech the firing handle being accessible at all elevations of the howitzer. In case of emergency the piece may be fired by means of a lanyard.

The *elevating mechanism* consists of elevating arcs, which tip the cradle, is operated by a handwheel on the left side of the carriage

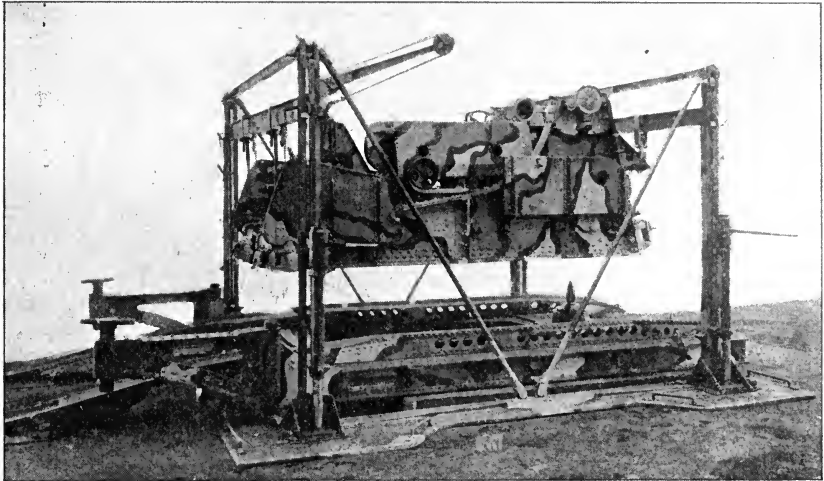

MOUNTING THE TOP CARRIAGE.

through a system of gearing. A maximum elevation of 60° can be obtained.

In connection with the elevating gear a quick-loading gear is provided, by means of which the howitzer can be quickly brought to the loading angle ($9^{\circ} 15'$) and again elevated without the use of the slower method of using the elevating gear. A handwheel on the right side of the carriage is used to operate the quick loading gear.

The *top carriage* is a structural steel, built-up unit. The top of the flasks forming the top carriage carry the trunnion bearings for the cradle. At the front of the carriage a pintle bearing is provided, which bears on the pintle of the platform, thus providing a means of rotating the top carriage and traversing the piece. A pinion at the rear of the carriage meshing with a rack on the platform swings the

rear end of the carriage in traverse. A traverse of 10° each side of center is thus obtained.

A windlass mounted on the top carriage is used for setting up and dismantling the unit.

At the rear of the top carriage is attached a loading platform on which is mounted a loading crane for handling the shells. On the loading platform tracks are provided for a rammer car which is used to transport a projectile from the loading crane to the breech and to ram it into the bore of the howitzer. This ramming of the projectile is accomplished by means of a movable chain on the rammer car which has suitable lugs for engaging the shell and is operated by cranks on the rammer car.

The platform on which the top carriage rests is a structural-steel unit composed of a top and bottom plate secured by channels. The middle portion is open and has a trunk section to provide a space for the howitzer to recoil at high angles of elevation. The traversing

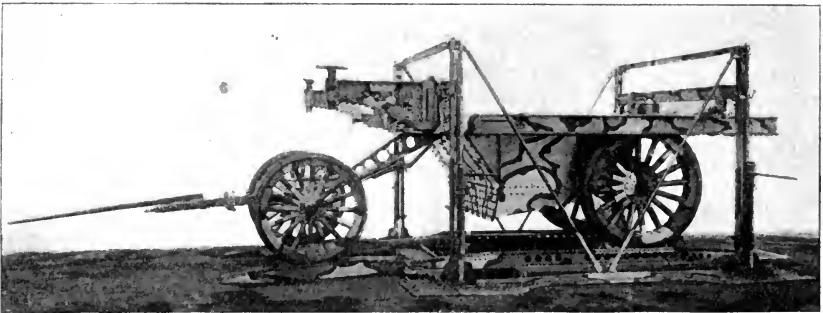

METHOD OF LOWERING PLATFORM.

rack is secured to the rear end of the platform. Built-up steel floats are attached to the rear of the platform by swinging arms, which function to give stability to the mount at extreme angles of azimuth. Axle brackets and attachments for the false trail of the transport wagon are provided for use when traveling.

Accessories.—A considerable number of tools and accessories are required for the erection, operation, and maintenance of the piece. The principal ones are as follows: Erecting frame, shot truck, sights, transport wheel tracks, track for shot truck, shell tongs, shot barrow, air pump, liquid pump, hydraulic jacks, wheel blocks and mats, axle-lifting levers, etc.

The erecting frame is composed of structural-steel beams. It is operated by hydraulic jacks and is used in assembling and dismantling the piece. It may also be used as a derrick for handling shells. When used for this purpose, a trolley attachment with shell tongs is provided.

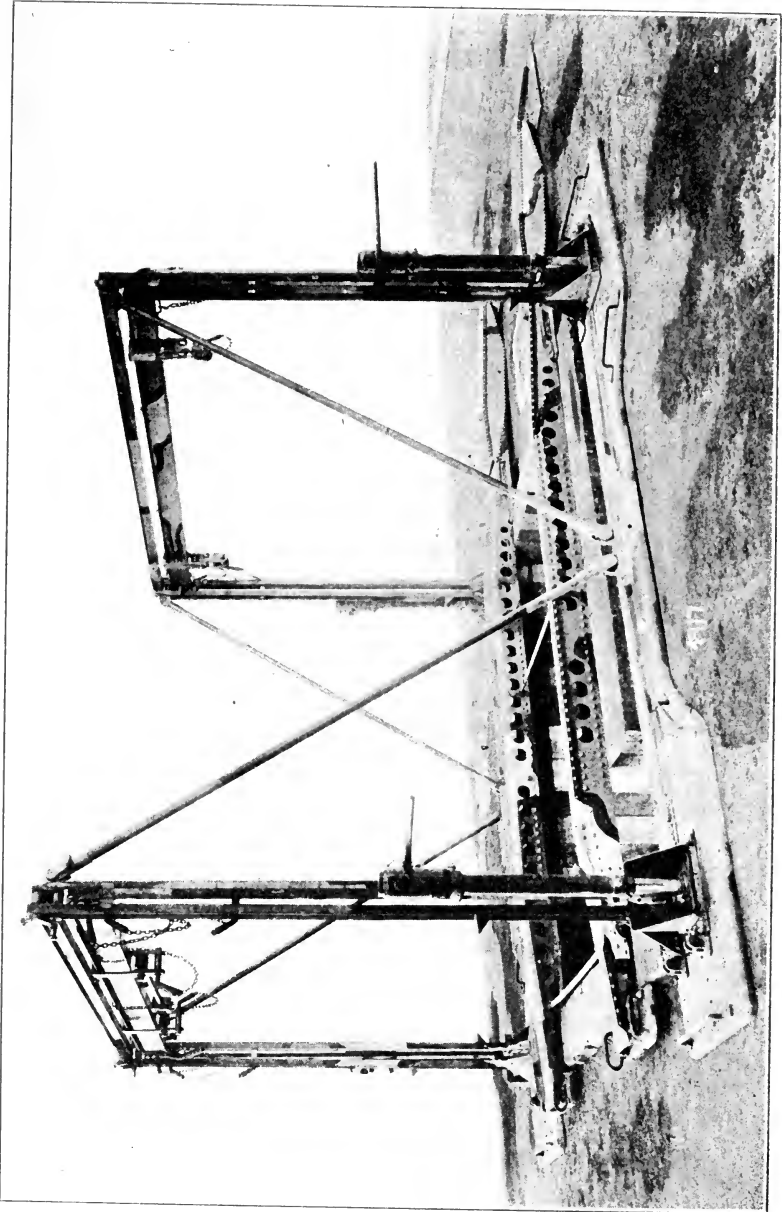

ERECTING FRAME IN POSITION.

The shot truck is a four-wheeled vehicle with flanged wheels fitting a track which is laid from the magazine to the piece, and will carry two of the projectiles. The track for this truck is 600 millimeters ($23\frac{1}{2}$ inches) gauge. It is supplied in built-up lengths of light steel rails joined by pressed-steel ties.

Weights, dimensions, and ballistics.

Weight of howitzer.....	pounds..	10,790
Length of howitzer.....	inches..	199.6
Rifling.....	Right hand, 1 turn in 40 calibers at origin to 1 turn in 20 calibers at a point 24.369 inches from the muzzle.	
Weight of powder charge.....	pounds..	38½
Weight of projectile.....	do....	356
Muzzle velocity.....	ft. per sec..	1,700
Maximum range.....	yards..	18,000
Weight of howitzer and breech mechanism.....	pounds..	10,831
Amount of traverse (right and left).....	degrees..	10
Maximum angle of elevation of howitzer.....	do....	60
Maximum angle of depression of howitzer.....	do....	1
Loading angle.....	do....	9¼
Normal length of recoil.....	inches..	44.83
Maximum recoil allowable.....	do....	46.73
Height to center of trunnions.....	do....	64.5
Weight of howitzer and transport wagon.....	pounds..	15,220
Weight of cradle and transport wagon.....	do....	14,605
Weight of top carriage and transport wagon.....	do....	12,545
Weight of platform and transport wagon.....	do....	16,230
Weight of complete unit in firing position.....	do....	41,296
Weight of erecting frame.....	do....	33,024
Sleigh (complete, filled with liquid and all pistons, packings, caps, etc.).....	do....	5,747
Cradle (complete, but without elevating arms).....	do....	4,068
Recuperator (steel forging only), completely machined.....	do....	3,931
Elevating arms (including quick-loading gear).....	do....	855
Top carriage (complete, with elevating and traversing gear, windlass, footboards, bearing caps, traversing rollers, rear clips, draft hook, cradle lock, jack rollers, etc.).....	pounds..	6,685
Rammer car.....	do....	540
Loading platform.....	do....	555
Loading-crane bracket and loading crane.....	do....	441
Shell tongs.....	do....	39
Shot truck.....	do....	430
Platform (complete, with pintle springs, swinging arms, and floats).....	do....	11,895
Transport wheel tracks with inclined planes.....	do....	1,175
Erecting frame (complete, with hydraulic jacks).....	do....	3,024

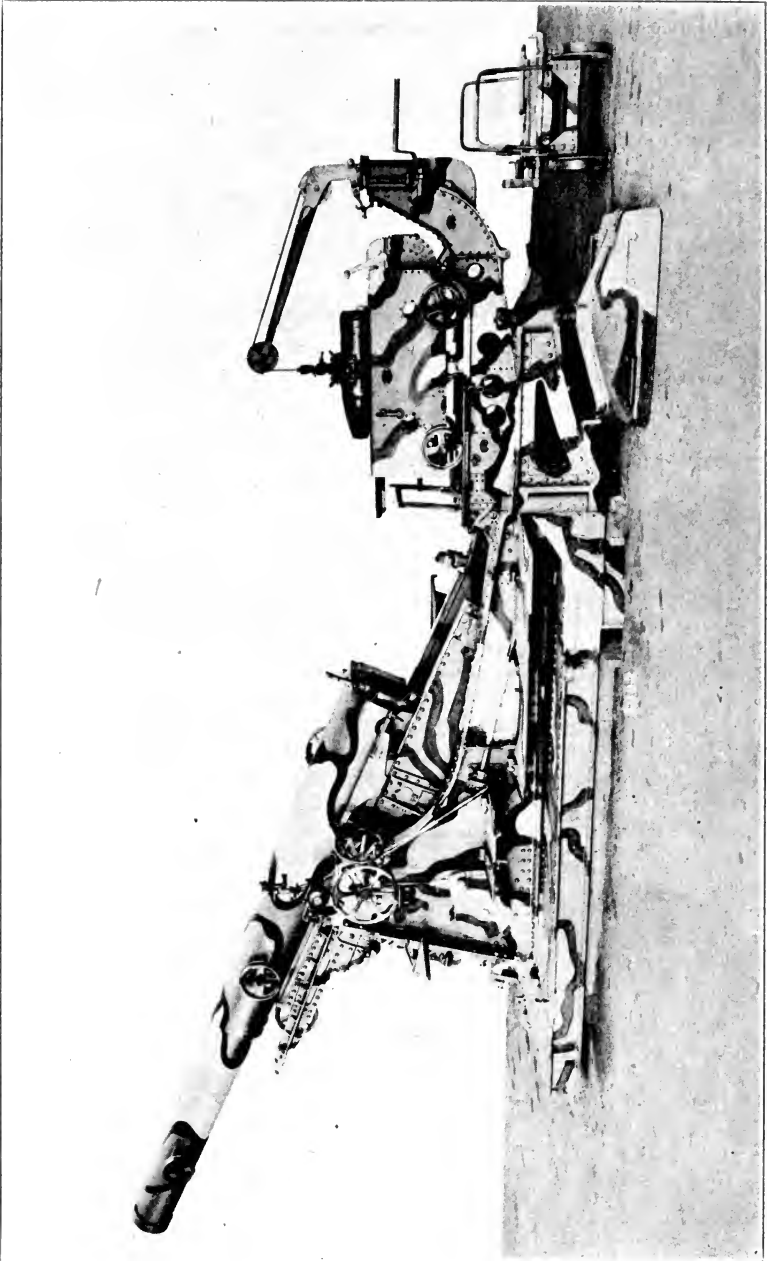

LEFT SIDE VIEW.

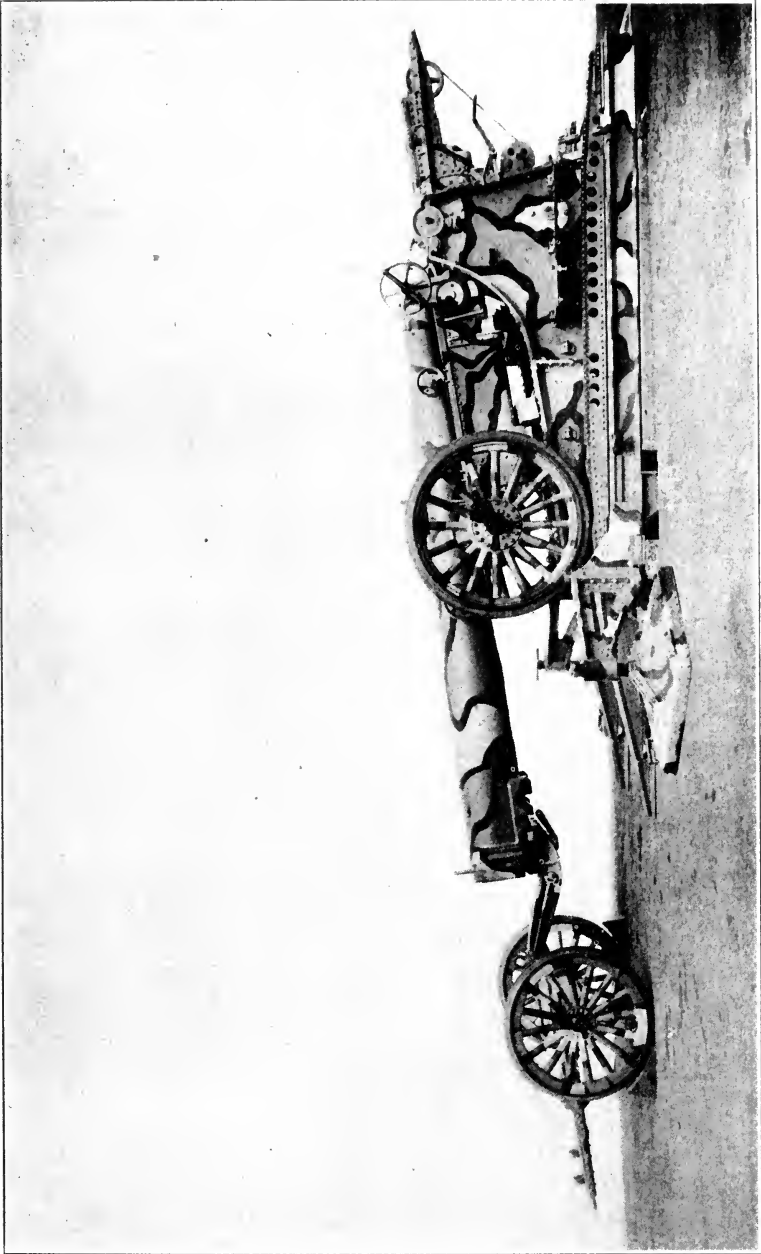

MOUNTING THE HOWITZER.

240-MILLIMETER HOWITZER TRANSPORT LIMBERS AND WAGONS.

In order to transport the complete carriage there are provided four transport vehicles, namely, the howitzer transport wagon, top carriage-transport wagon, platform-transport wagon, and cradle-transport wagon. Each wagon consists principally of a limber, false trail, rear axle, and wheels.

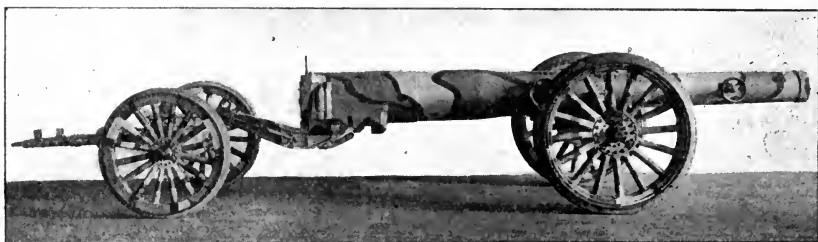

HOWITZER TRANSPORT WAGON.

The limber consists of two wheels, an axle, pole, and turning arc, all of which are similar for each wagon.

The pole is composed of two steel parts joined with a flexible spring coupling, consisting of a coil spring, plunger, and hinged joint, providing a movement of about 15 inches at the end of the pole to

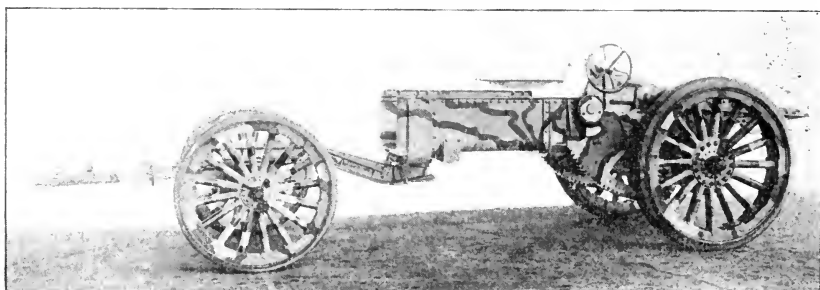

CRADLE TRANSPORT WAGON.

make up for any difference in height between the limber and the vehicle to which it may be coupled. This spring coupling also relieves the vehicles of any sudden shocks during transportation.

Each limber is provided with a pintle over which fits the lunette ring of its false trail. Safety chains are attached to the pole to hold the false trail on the pintle in proper position.

The turning arc is attached to the axle and the false trail bears on it as it rotates around the pintle.

Four false trails are provided, one for each wagon. They are similar in most respects, especially the front end that has the lunette ring. This lunette ring floats in the trail and is surrounded by coiled springs which take up the shocks incidental to transportation.

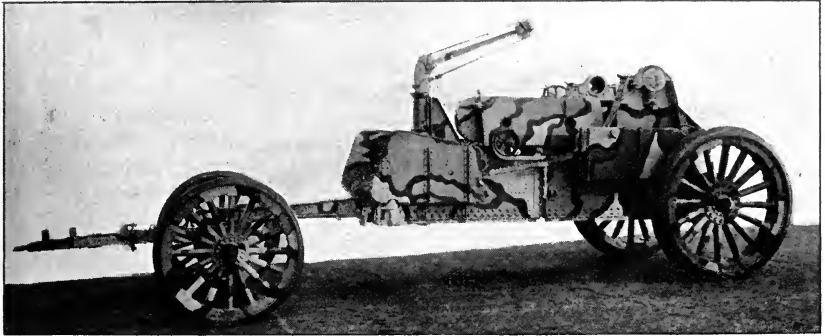

TOP CARRIAGE TRANSPORT WAGON.

The body of the false trail is formed to suit the heights of the unit to which it attaches and has brace rods for stiffening. A locking arrangement is provided to lock the units to the false trails and is operated by means of a hand lever.

The rear axle of the transport wagon is made of a special forging shaped to suit the unit which it carries. The axle for the howitzer-

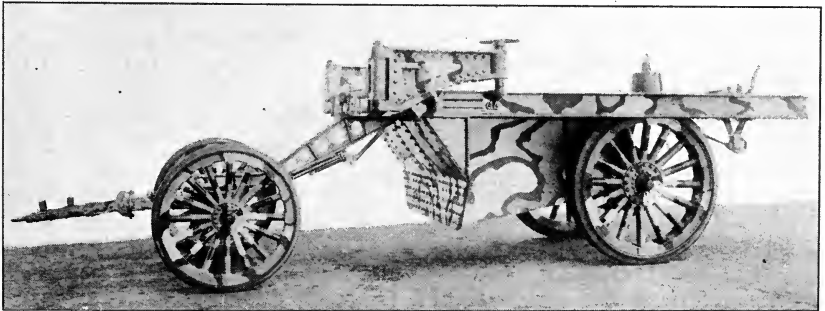

PLATFORM TRANSPORT WAGON.

transport wagon is curved to suit the radius of the howitzer and has pawls which lock the howitzer in place.

Band brakes are used and are alike for all four types of rear axles, but the brake-operating mechanism is different for the various transport wagons. The brakes on each vehicle are connected by a connecting lever shaft which is operated by a lever with ratchet and pawl. Provision is made for the setting of the brakes by the operator

of the hauling tractor by means of a rope attached to the operating lever and extending to the tractor.

When the complete carriage is set up for firing, the transport vehicles are close coupled by the false trail and form short units, having four wheels which can be drawn away. Brackets are provided attached to each axle for the brace rods which are used when the vehicles are unloaded and close coupled.

Both the limber and rear axles are equipped with standard rubber-tired wheels.

Weights and dimensions.

Howitzer and transport wagon (complete).....	pounds..	15, 200
Weight of transport wagon (close coupled).....	do....	4, 385
Weight of front wheels and axle.....	do....	1, 185
Weight of rear wheels, axle, and brake.....	do....	2, 750
Weight under front wheels.....	do....	4, 864
Weight under rear wheels.....	do....	10, 356
Wheel base.....	inches..	162
Overall length.....	do....	314
Cradle (with elevating arms and sleigh) transport wagon.....	pounds..	14, 605
Weight of transport wagon (close coupled).....	do....	4, 335
Weight of front wheels and axle.....	do....	1, 185
Weight of rear wheels, axle, and brake.....	do....	2, 700
Weight under front wheels.....	do....	3, 530
Weight under rear wheels.....	do....	11, 075
Wheel base.....	inches..	150
Overall length.....	do....	267
Top carriage (with rammer car, loading platform, loading crane) and transport wagon.....	pounds..	12, 545
Weight of transport wagon (close coupled).....	do....	4, 285
Weight of false trail complete for platform.....	do....	475
Weight of false trail for cradle, howitzer and top carriage, each.....	do....	450
Weight of front wheels and axle.....	do....	1, 185
Weight of rear wheels, axle, and brake.....	do....	2, 650
Weight under front wheels.....	do....	4, 030
Weight under rear wheels.....	do....	8, 515
Wheel base.....	inches..	181
Overall length.....	do....	280
Platform and transport wagon (including brake lever and draft hook).....	pounds	16, 230
Weight of transport wagon (close coupled).....	do....	4, 335
Weight of front wheels and axle.....	do....	1, 185
Weight of rear wheels, axle, and brake.....	do....	2, 675
Weight under front wheels.....	do....	4, 485
Weight under rear wheels.....	do....	11, 745
Wheel base.....	inches..	153
Overall length.....	do....	292
Weight of limber wheel.....	pounds..	350
Weight of transport wagon wheel.....	do....	1, 050
Howitzer transport wagon (close coupled).....	do....	4, 385
Cradle transport wagon (close coupled).....	do....	4, 335
Top carriage transport wagon (close coupled).....	do....	4, 285
Platform transport wagon (close coupled).....	do....	4, 335

Maximum width of transport wagons (platform).....	inches..	102
Maximum height of transport wagons (top carriage).....	do....	102
Minimum road clearance (distance between lowest point of wagon and ground)	
	inches..	15
Diameter of smallest circle in which a transport wagon will turn.....	do....	544
Wheels on transport wagons, rubber tired.....	do....	60 by 8
Wheels on limber, rubber tired.....	do....	49 by 4
Limber wheels:		
Width of track, center to center of tire.....	do....	60. 83
Bearing surface.....	do....	3. 54
Rear wheels:		
Width of track, center to center of tire.....	do....	63. 84
Bearing surface.....	do....	4. 74
Maximum width of widest transport wagon (platform).....	do....	102
Maximum height of highest transport wagon (top carriage).....	do....	102
Maximum overall length of longest transport wagon (howitzer).....	do....	314

ANTI-AIRCRAFT ARTILLERY.

In considering the question of antiaircraft matériel it is to be remembered that the science of anti-aircraft gunnery has changed probably to a greater extent than that of any other branch of the service. It was unheard of at the beginning of the war, and in consequence has grown from nothing at all to an important phase of operations. As a result, matériel is constantly changing and can not be said to have reached a definite basis even at this time. The matériel was greatly affected also by the change from "position warfare" to warfare of motion; portability changing from a somewhat neglected factor to one of paramount importance.

In field artillery practice range problems are presented in connection with mortars, howitzers, and guns, but the results to be accomplished and the problems in connection with each of these weapons are quite different. The provided elevation of the guns of some calibers is small, while the muzzle velocity of some of the howitzers and all of the mortars is comparatively low; also the traverse of all three different types of weapons is limited. The field target is usually stationary, maps being available for establishing its position, and ample time is available in which to figure its range. Observation of the point of fall of one shot serves as a guide in correcting the range for the next shot. Frequently it is possible to choose atmospheric conditions under which the weapon would be employed, and assisting or opposing longitudinal windage, or driftage due to side windage, is calculated with the aid of wind gauges.

For anti-aircraft service the problem is entirely different. The single weapon must be able to cover the elevations of all three types of the field artillery weapons and preferably have a traverse of 360° . These wide variations in elevation introduce serious recoil problems, and the difference in the traverse problem may be to some extent illustrated by reference to the fact that the total traverse of the 75-millimeter French, model 1897 M1, field gun is only 6° .

Instead of a stationary target there may be presented one whose speed is one-sixth of the speed of the projectile itself and whose course can in no wise be forecast by road direction or terrain formation and whose position may be at any vertical or horizontal angle. The possible altitude and speed of airplanes increased from time to time, making useless the earlier and present basic data to be employed in the design of protective matériel. Under certain conditions of airplane approach the range must be calculated on the instant and there is no choice as to atmospheric conditions. As the target is not stationary, range corrections are difficult to estimate by observation.

While gauges may indicate the direction and force of the wind at the altitude at which they are set, they furnish no indication of air currents existing at other altitudes through which it might be necessary for the anti-aircraft projectile to pass. With the flat trajectory of a fieldpiece at but a few degrees elevation, the density of atmosphere through which the projectile must pass is largely uniform, while at

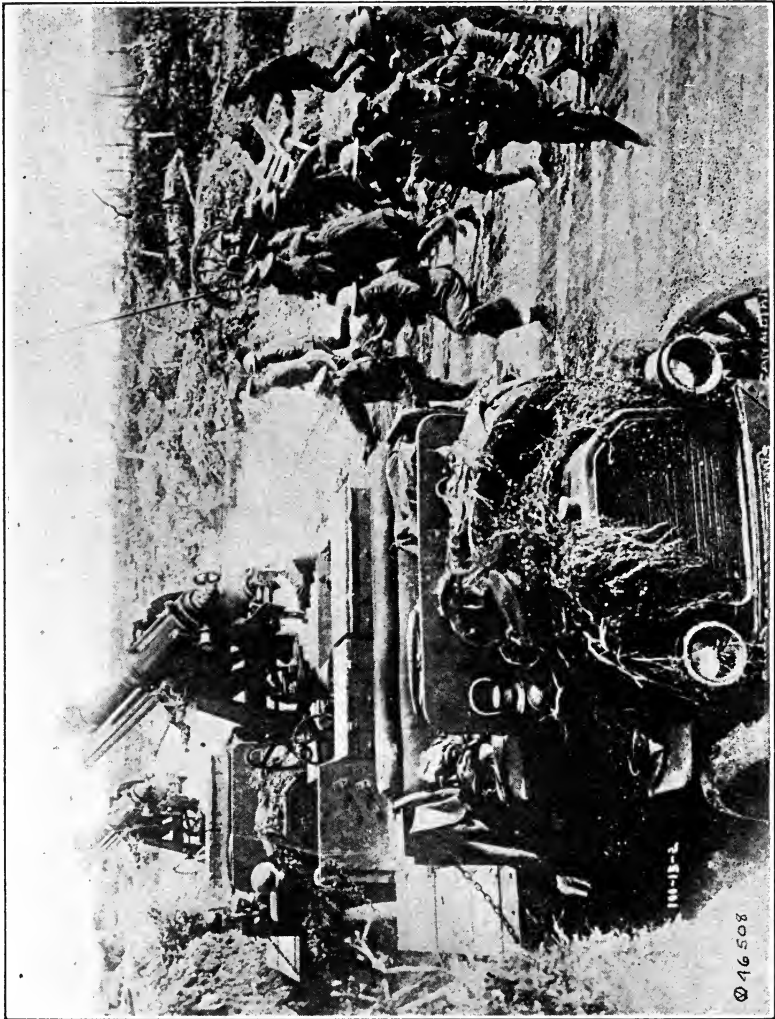

CANADIAN ANTI-AIRCRAFT GUN MOUNTED ON AUTOTRUCK IN ACTION.

high angles of fire with anti-aircraft guns the projectile passes through atmospheres of different rarefactions, and hence different resistances to the passage of the projectile. These influences affect the trajectory of the projectile, the rate of travel of the projectile, and the time element of the burning of the fuze.

With field artillery, shrapnel is employed with both a time fuze and an impact fuze, and high-explosive shell with impact fuze only, but

anti-aircraft disrupting projectiles are fitted only with time fuzes, as otherwise a projectile which has missed its aerial mark would be apt to cause damage within friendly lines through impact explosion on reaching the ground.

As there is practically no position which is entirely free from the possibility of aircraft attack, and as there is no means of determining the direction from which such attack may come, ready mobility of anti-aircraft guns is most desirable, and as opportunity to reach the target is frequently only momentary, rapidity of sighting and of firing is essential. In the case of indirect fire from a camouflaged position, the gunner has not even had a view of the approaching plane, but must lay his gun on the basis of telephone data, or data otherwise transmitted from the battery commander's station.

The anti-aircraft target may be a balloon—either stationary or towed—a dirigible, or an airplane, but is most frequently the latter. Location of the position of balloons or dirigibles is comparatively simple, as compared with airplane location, owing to the size of the target and the stationary position or low speed of motion. For night fire, searchlights or other illuminating means are required, and for night fire or protective fire in thick weather, sound-locating devices are employed.

The earlier fire from anti-aircraft artillery was directed solely from the burst; that is, by firing a shot, and judging of the direction of the next shot solely by observation of the nearness to which the burst of the first shot had approximated the position of the target. In the meantime, however, the position of the target had changed. This system has given way to the use of an elaborate system of instruments for the determination of fire in accordance with certain established principles.

In the attack upon aircraft the desired end may be accomplished either by the destruction of the aircraft itself or by the disabling of its occupants, in which latter case the destruction of the aircraft would follow. The methods adopted include destruction by incendiarism, by direct hits, by flying particles from exploding shell or shrapnel, and by shell shock. Methods of fire may involve explosive projectiles from a single gun, salvos or barrage fire from a number of guns, rapid firing from pom-poms (small caliber guns, firing explosive projectiles), or from machine guns firing small arm ammunition.

Because of the important field played by aerial sound-detecting apparatus, searchlights, and telephony, including wireless, future progress in the design of anti-aircraft artillery will consider these subjects. With the perfection of airplane motors and their interconnected functioning apparatus, the design of aircraft, and the art of flying, other factors upon which the design of artillery equipment should likewise be based, enter into this problem.

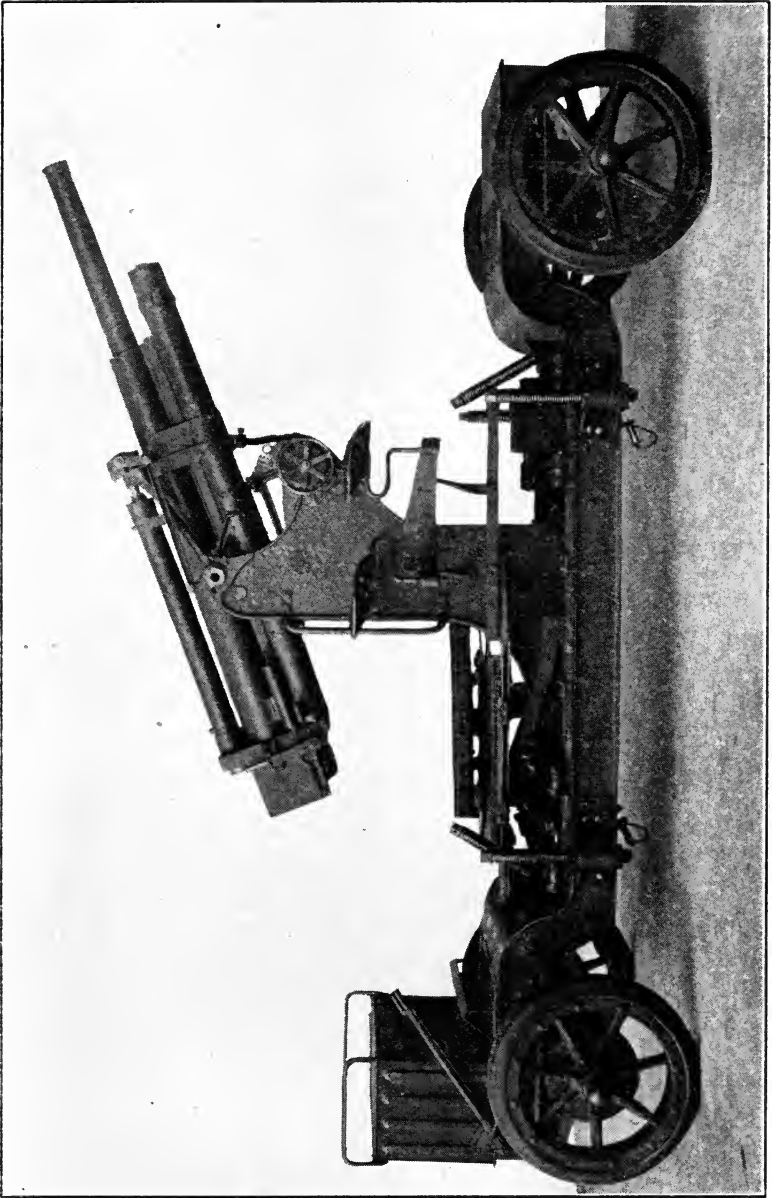

RIGHT SIDE OF AUTO-TRAILER CARRIAGE IN TRAVELING POSITION.

3-INCH ANTI-AIRCRAFT GUN MATÉRIEL, MODEL 1918.

It is hardly possible to estimate how great will be the future importance of the perfection of the country's aerial defense from a strategic point of view. Aviation as an offensive arm will remain a principal arm, and anti-aircraft artillery, as a defense branch, will play the part that coast artillery plays to the naval squadrons.

Anti-aircraft gunnery differs from other forms of gunnery, such as field-artillery problems. It is a new subject, one more complicated than any other artillery problem, and consequently one which essentially demands new methods and modes of measurement. Development, however, has led to the design of the 3-inch auto-trailer carriage.

The 3-inch auto-trailer carriage unit consists of a 3-inch gun, model 1918, anti-aircraft, and a 3-inch auto-trailer carriage, model of 1917, mounted on a four-wheel trailer truck, having springs and solid rubber tired wheels. The gun and the mount remain fixed on the trailer, both in traveling and in battery positions.

The muzzle velocity of the gun is 2,400 foot-seconds. Both shrapnel and high-explosive shells, each weighing about 15 pounds, are employed. At a maximum elevation of 85° the maximum vertical ordinate, limited by the time fuze, is 7,940 meters. At minimum elevation of 10° the projectile strikes the ground at approximately 6,100 meters. At 23° elevation the bursting vertical ordinate is 1,176 meters, and the horizontal ordinate approximately 7,025 meters.

The recoil mechanism is similar to that employed with the American 75 millimeter, model 1916, field gun, but with the use of a spear-head counter-recoil buffer. This recoil mechanism is of the hydro-spring type and the variable adjustment of the stroke is governed by a rotating valve, the movement of which moves port holes behind the edges of three lands permitting the passage of oil to the by-passing recesses.

The anti-aircraft gun, together with the recoil mechanism, is held by the cradle and swings from 10° to 85° elevation in the trunnion bearings of the top carriages. A base plate rigidly bolted to the trailer chassis supports the top carriage on traversing rollers on which the top carriage rotates 360° in azimuth around a pintle on the base plate.

The trailer carriage is equipped with outriggers. Stability and lifting jacks which, when in firing position, rest on detachable floats

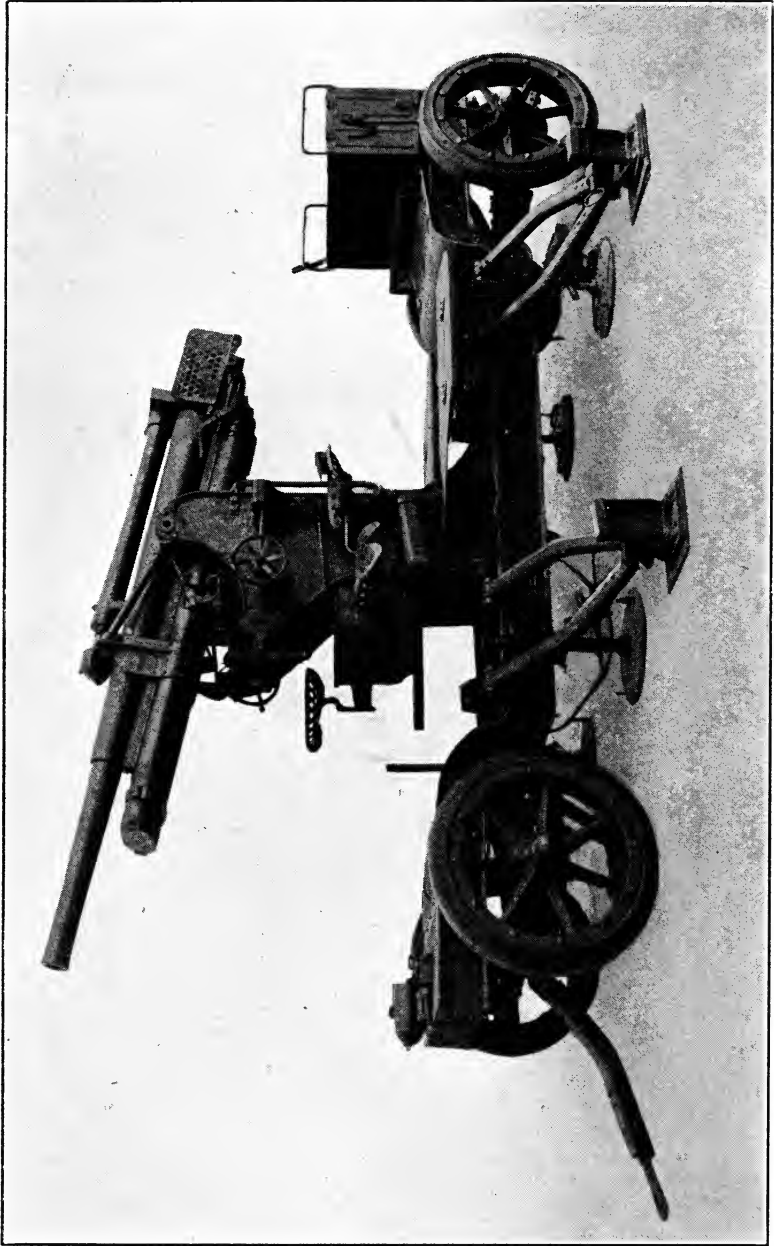

FRONT VIEW OF CARRIAGE IN BATTERY.

on the ground and support the entire weight of carriage and trailer. These outriggers and jacks are employed to stabilize this unit when in action and to prevent the mount from overturning when the gun is fired at low angles of elevation.

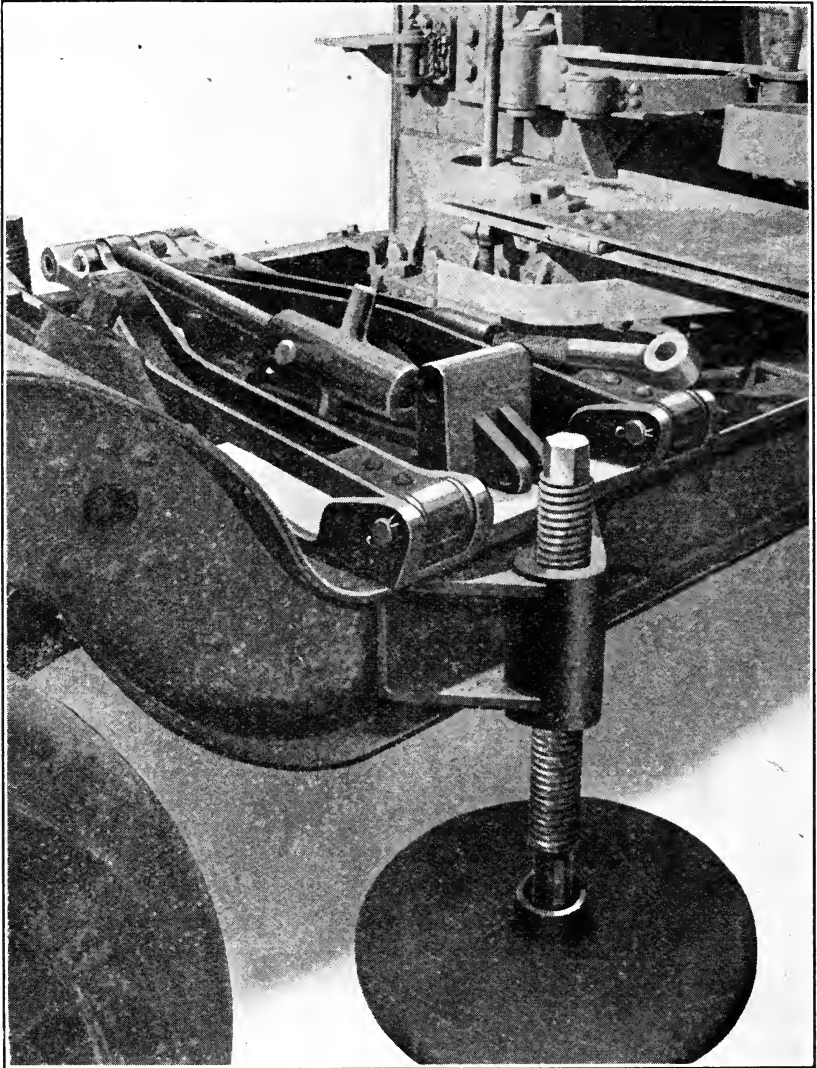

VIEW OF REAR OUTRIGGERS FOLDED; OUTSIDE END OF RIGHT OUTRIGGER BRACE READY TO BE PLACED IN RECEPTACLE; SCREW JACK WITH OUTRIGGERS FOLDED.

In traveling position the outriggers are folded up, the jack screws raised, the floats and spades being carried in another vehicle, with the exception of the stability jack floats which are attached to the jack screws. Traveling locks are provided to lock the gun at about

**3 IN. AUTO-TRAILER, ANTI-AIRCRAFT CARRIAGE
MODEL OF 1917
LONGITUDINAL SECTION**

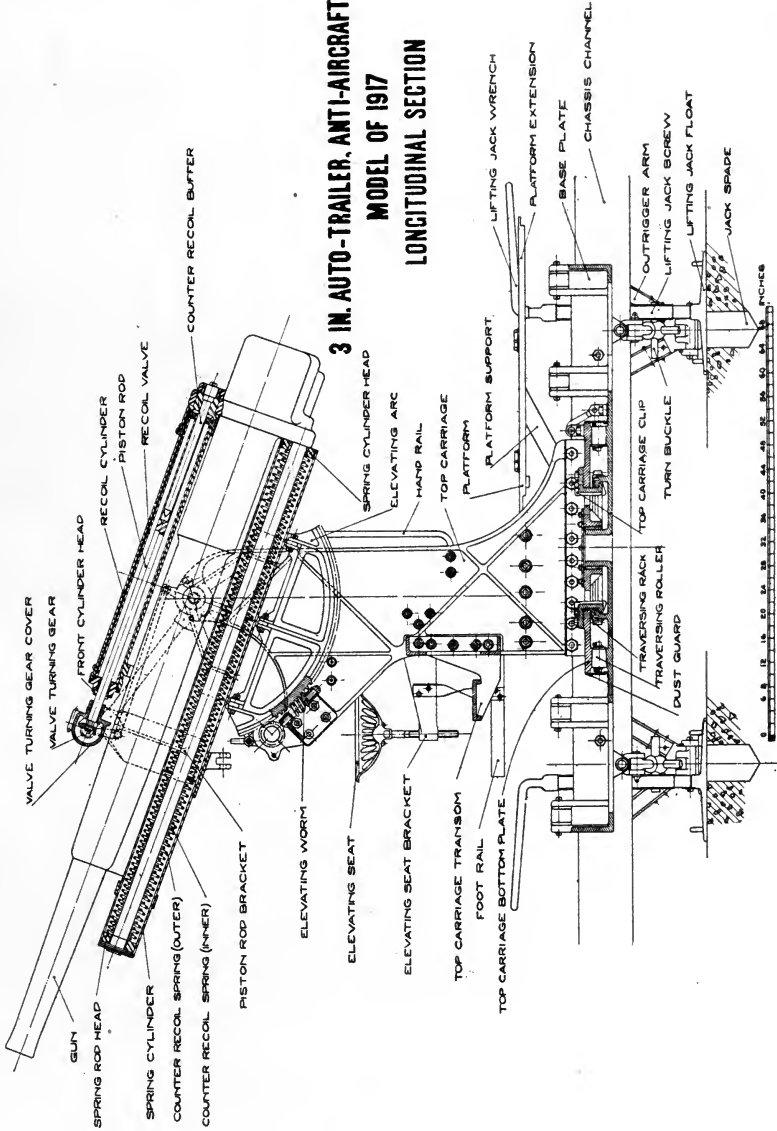

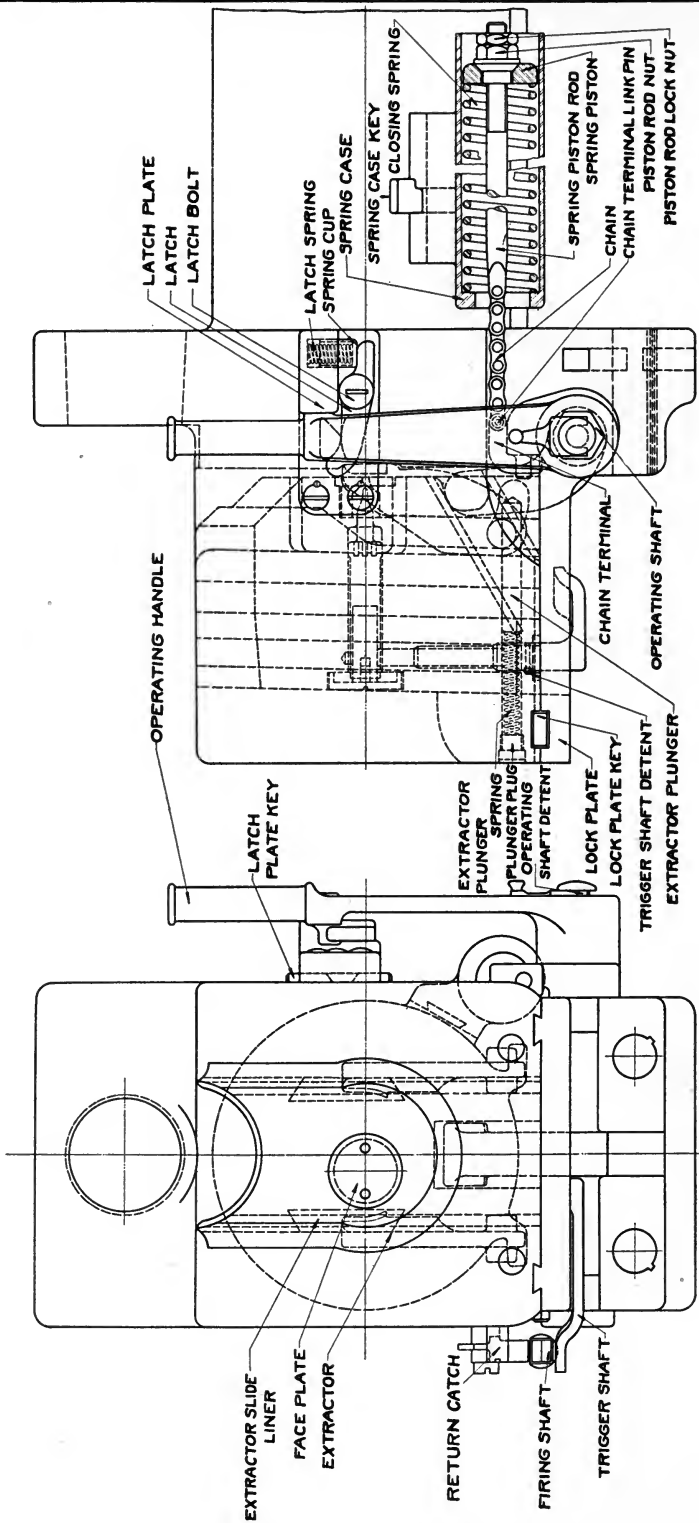

20° elevation to protect the elevating mechanism. In azimuth the carriage is locked lengthwise of the trailer to remove unnecessary strains from the traversing mechanism when the unit is traveling.

Adjustable seats and foot rests for the gunners and platforms that fold up when traveling are fastened to the top carriage. This unit is considered able to negotiate any roads suitable for field artillery. Weight of complete unit is approximately 14,000 pounds.

Fixed ammunition is used with these guns, consisting of time-fuzed high-explosive, illuminating shell, tracer shell, and shrapnel. All the shell and shrapnel are issued fuzed.

3-INCH AUTO-TRAILER CARRIAGE.

The 3-inch auto-trailer carriage consists of a 3-inch gun, model of 1918, anti-aircraft, and a 3-inch auto-trailer carriage, model of 1917, mounted on an autotrailer.

The gun, of which there are two models, 1918 and 1918MI, is built up of nickel-steel forgings and consists of a tube, a jacket, and a breech ring, the latter being screwed to the rear end of the jacket forming a housing for the breech mechanism. Lugs are provided at the top and bottom of the breech ring to which are secured, respectively, the recoil cylinder and counter-recoil spring rods. The 1918MI model differs from the 1918 model only in the jacket which is 1.6 inches longer at the threaded part allowing a greater thickness of metal in rear of the jacket, thereby strengthening the gun around the chamber.

The breech mechanism is practically the same as that used on the 75-millimeter field gun, model of 1916 (American) (see p. 73), being of the drop block type, semiautomatic, and operated by a handle on the right side of the breech which is pulled backwards and down to open the breech.

Weights, dimensions, and ballistics of gun.

Weight of gun (including breech mechanism).....	pounds..	1, 966
Caliber.....	inches..	3
Total length of gun.....	do.....	129. 69
Length of bore.....	do.....	120
Volume of chamber.....	cu. in..	200
Length of rifled portion of bore.....	inches..	95. 87
Number of grooves.....		24
Width of grooves.....	inches..	0. 2927
Depth of grooves.....	do.....	0. 03
Width of lands.....	do.....	0. 10
Muzzle velocity.....	ft. per sec.	2, 400
Twist, right hand increasing from one turn to 50 calibers at the origin to one turn in 25 calibers at a point 8.87 inches from the muzzle and uniform from that point to the muzzle.		

The carriage comprises the top carriage and cradle. The top carriage consists of two side frames bolted to a bottom plate which in turn rests on a circular roller frame and rotates about a pintle on

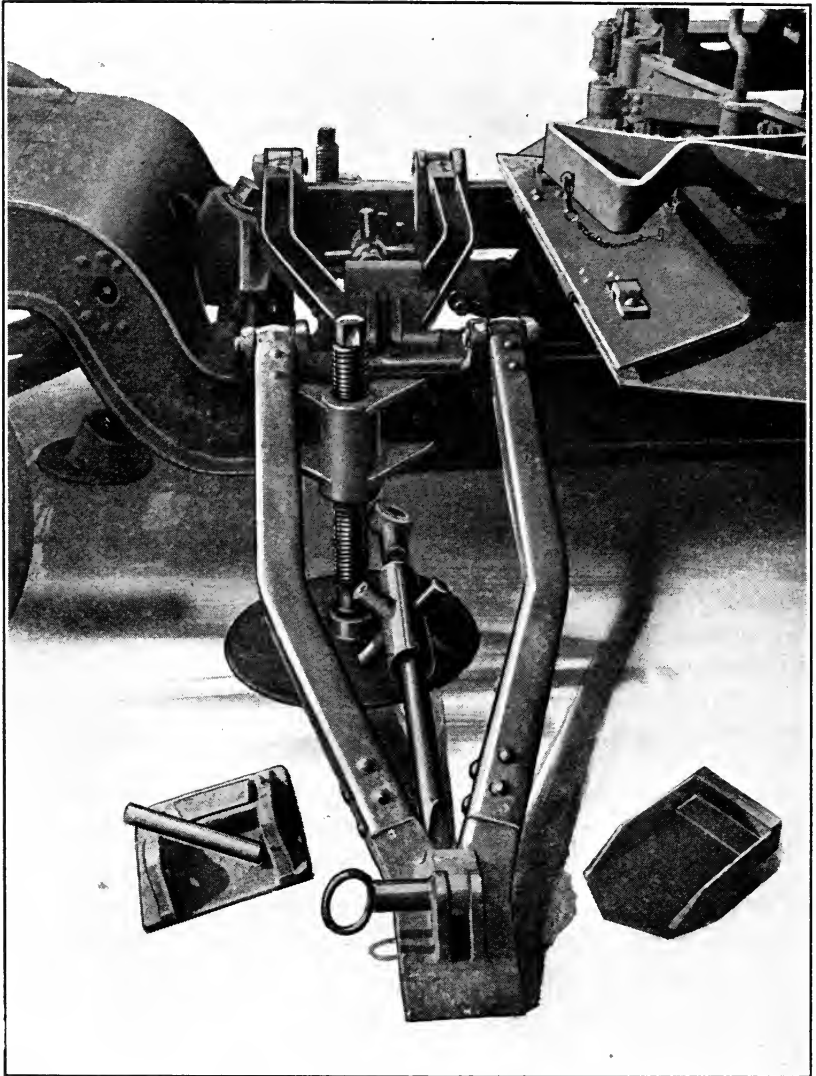

VIEW OF RIGHT REAR OUTRIGGER WITH JACKSPADE AND FLOAT REMOVED AND BRACE DROPPED FROM SHACKLE AT INSIDE END; LEFT REAR OUTRIGGER IN POSITION, WITH FLOAT CONNECTION FOLDED.

the base plate. The base plate is rigidly bolted to the trailer chassis and is equipped with outriggers and stability and lifting jacks which when in firing position, rest on detachable floats on the ground and support the entire weight of the carriage trailer. The top carriage

is prevented from tipping or lifting from the traversing rollers by a front and rear clip which are fastened to the bottom plate and which engage an annular flange on the base plate.

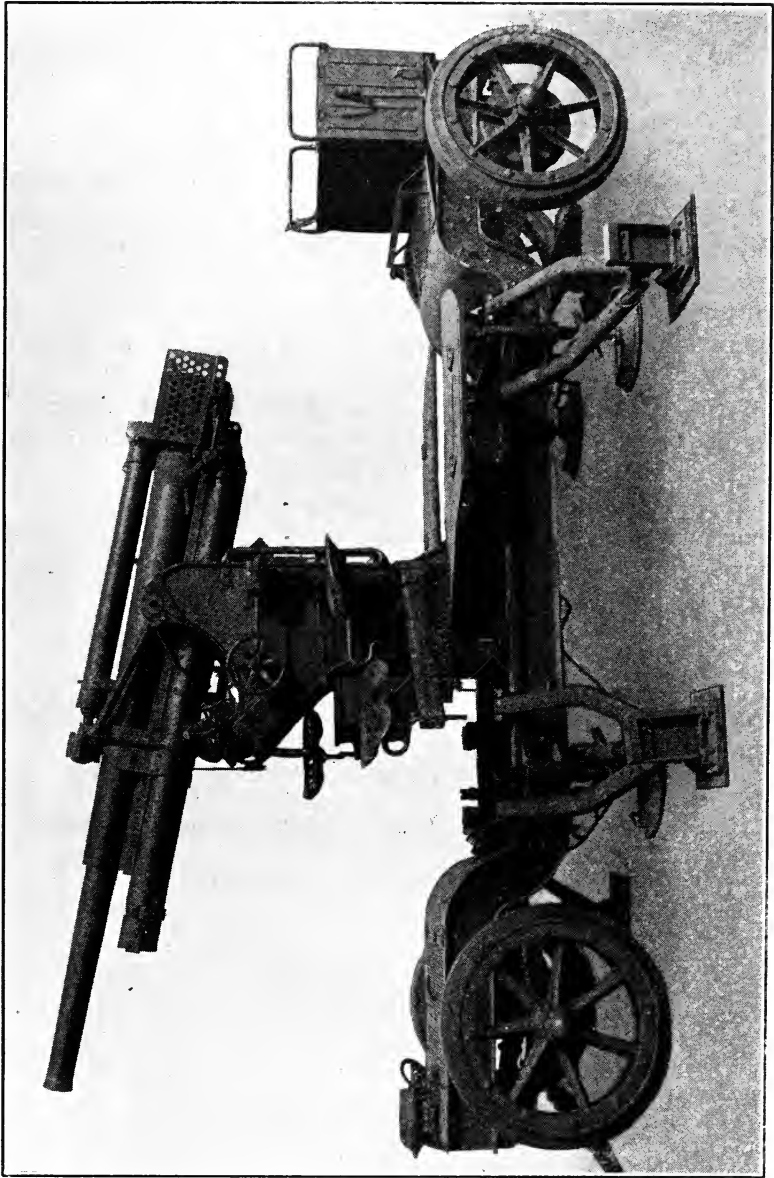

SIDE VIEW OF CARRIAGE IN BATTERY POSITION.

The recoil mechanism is of the variable recoil hydro-spring type and operates the same as that of the 75-millimeter field gun, model of 1916. The only noticeable difference between the two is that a

spear buffer is used instead of a valve in the buffer rod head as is used in the 75-millimeter gun. The length of recoil varies from 16 inches at 85° elevation to 40 inches at 10° elevation.

An elevating arc having teeth is secured to the lower side of the cradle and meshes with a Hindley worm which is driven through bevel and spur gears by a handwheel located on the right side of the top carriage.

The traversing mechanism is attached to the left side of the top carriage. The handwheel, through bevel gears, a worm, a worm wheel, and a friction clutch, rotates a pinion which in turn meshes with an annular rack bolted to the base plate. The pinion when rotated causes the top carriage to revolve about its pintle on the traversing rollers.

Four seats are attached to the top carriage, two on either side, which are used by the personnel who operate the sights and elevating and traversing mechanisms.

Platforms are bolted to both sides at the rear of the top carriage for the personnel who load and fire the piece. The platforms may be folded up and the seats swung to one side for traveling.

When traveling, the gun is locked at an elevation of about 20° and lengthwise of the trailer by upper and lower traveling locks for the purpose of taking up any strains or shocks which might come on the elevating or traversing mechanisms.

Weights and dimensions of Carriage.

Weight of carriage unit complete (including spare ammunition chest filled with ammunition, tools, and accessories).....	pounds..	14, 085
Weight of cradle (recoil cylinder complete, including oil, trunnions, gun slides, piston rod bracket complete, and spring cylinder with springs assembled).....	pounds..	1, 293
Weight of trailer (with ammunition chest only, without tools and accessories or ammunition)	pounds..	4, 085
Weight of trailer with carriage, gun, and ammunition chest only.....	do....	13, 200
Weight under front wheels (fully equipped).....	do....	7, 075
Weight under rear wheels (fully equipped).....	do....	7, 010
Weight of one round of ammunition (complete).....	do....	26. 8
Maximum angle of elevation.....	degrees..	85
Minimum angle of elevation.....	do....	10
Traverse of carriage.....	do....	360
Maximum length of recoil.....	inches..	40
Minimum length of recoil.....	do....	10
Number of rounds in ammunition chest.....		14
Number of rounds in spare ammunition chest.....		16
Height from ground to center of trunnions.....	inches..	85
Height from ground to top of gun (in traveling position).....	do....	119
Maximum width of carriage.....	do....	77
Maximum length of carriage (drawbar up).....	do....	230
Maximum length of carriage (drawbar down).....	do....	243

**3 IN. AUTO TRAILER CARRIAGE
MODEL OF 1917
ASSEMBLED VIEW**

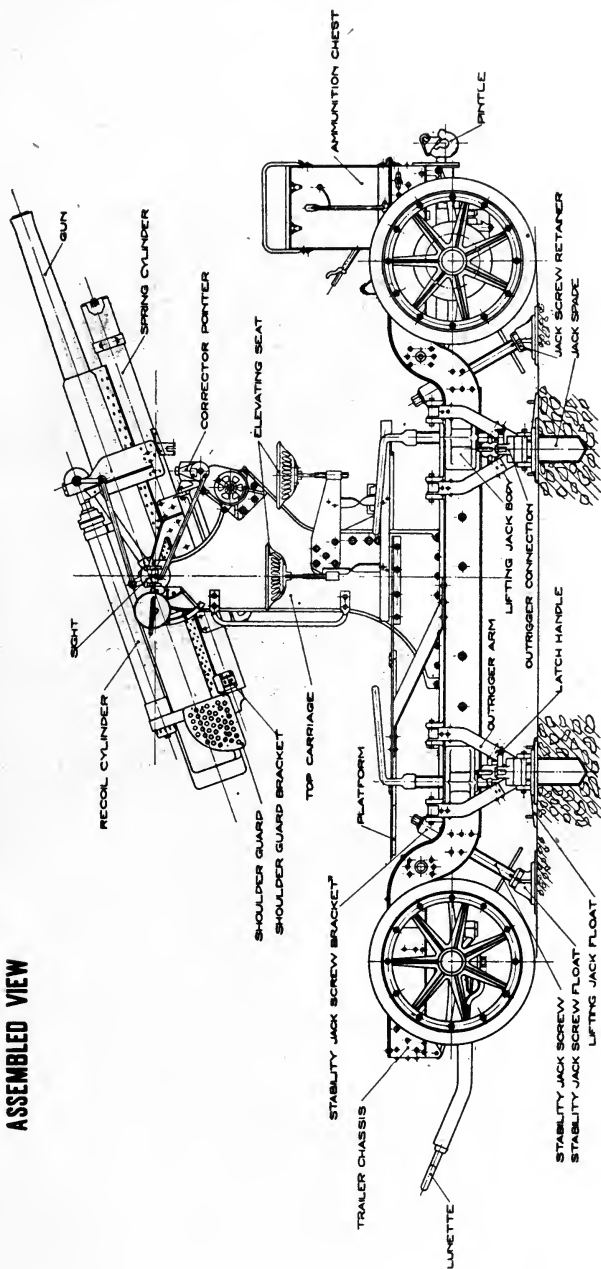

The trailer upon which the carriage is mounted consists of two parallel side frames, between which are secured the cross members, bracing and making up the complete chassis. Between the front and rear wheels the frame is so depressed that the base plate of the carriage is on the same plane as the hubs of the wheels, thus bringing the center of gravity of the carriage lower and lessening the possibility of overturning. The space at the front of the trailer formed by the side frames and cross members is provided with a bottom

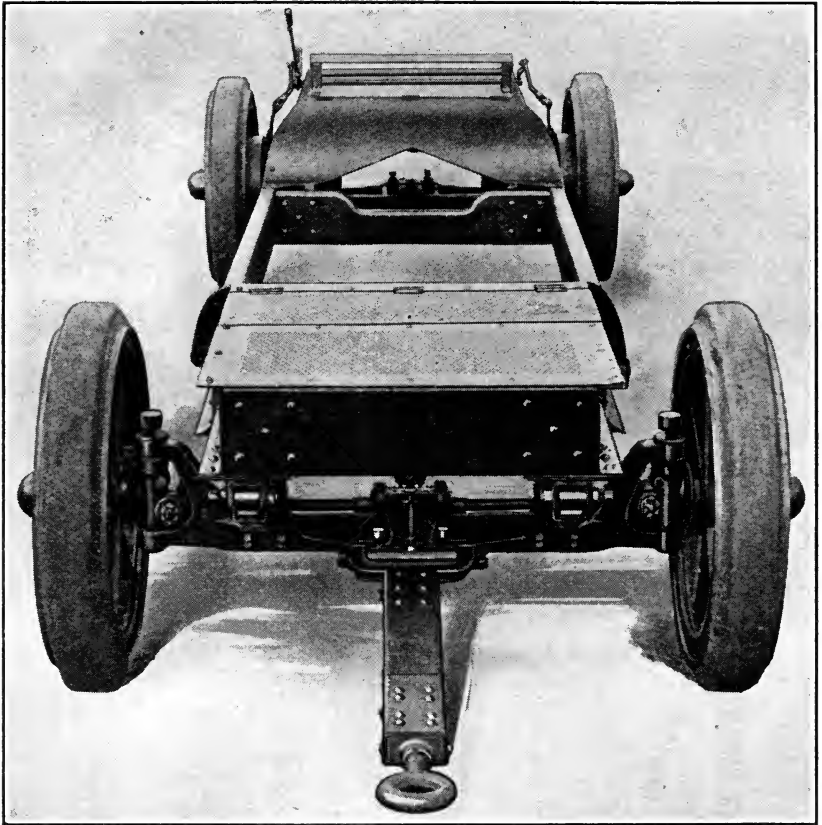

FRONT VIEW.

plate, a top plate and hinged cover, and is utilized as a tool box. The rear section is similar to the front, except that a support is provided for the ammunition chest. The chest which carries 16 rounds of ammunition also serves as a seat for the operators of the carriage. A foot rest is fastened to the rear tool box cover. The chassis is supported on the axles, both front and rear by semielliptical springs.

The trailer is towed and steered by a drawbar equipped with a lunette and fastened to the front axle in such a manner that the

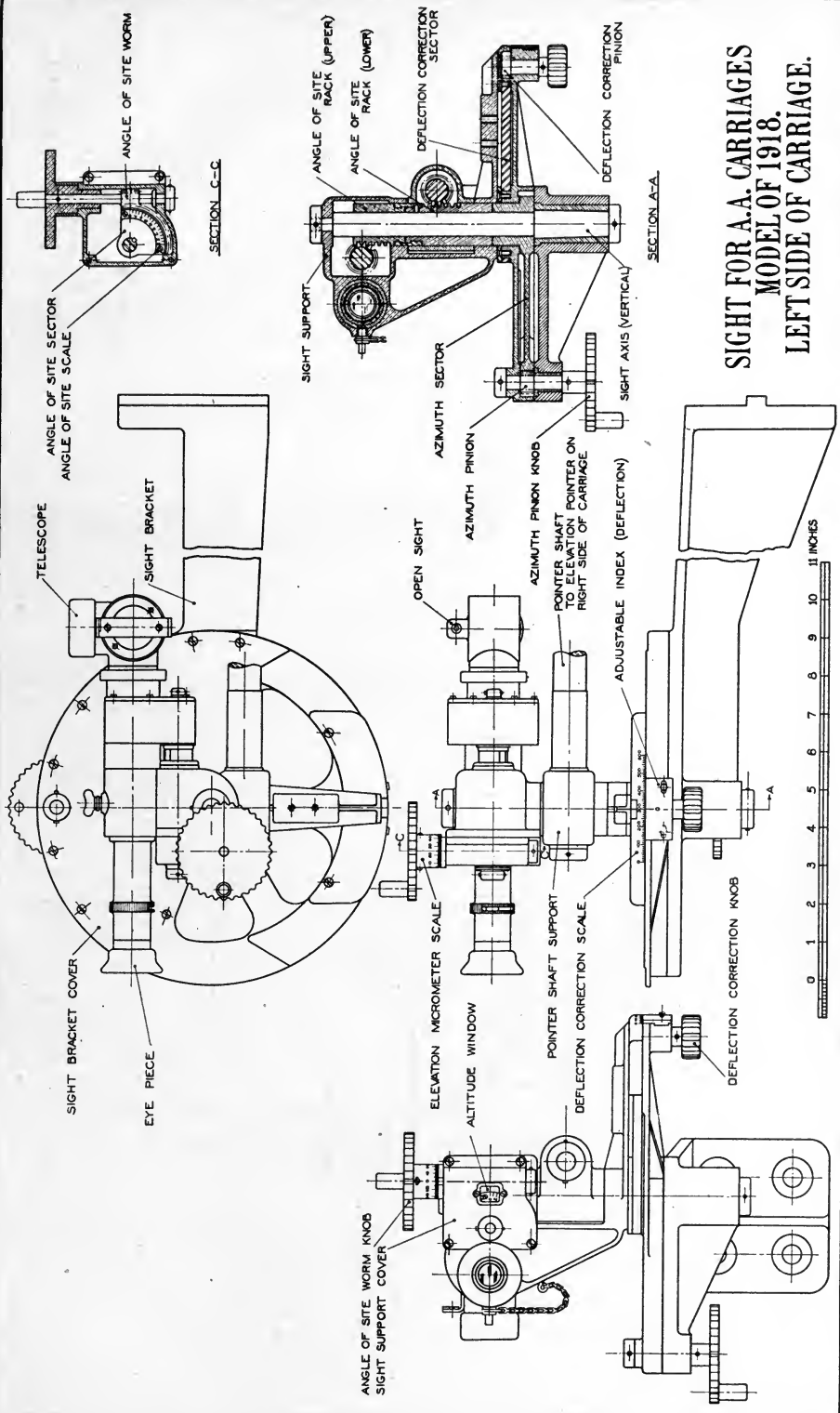

SIGHT FOR A.A. CARRIAGES
 MODEL OF 1918.
 LEFT SIDE OF CARRIAGE.

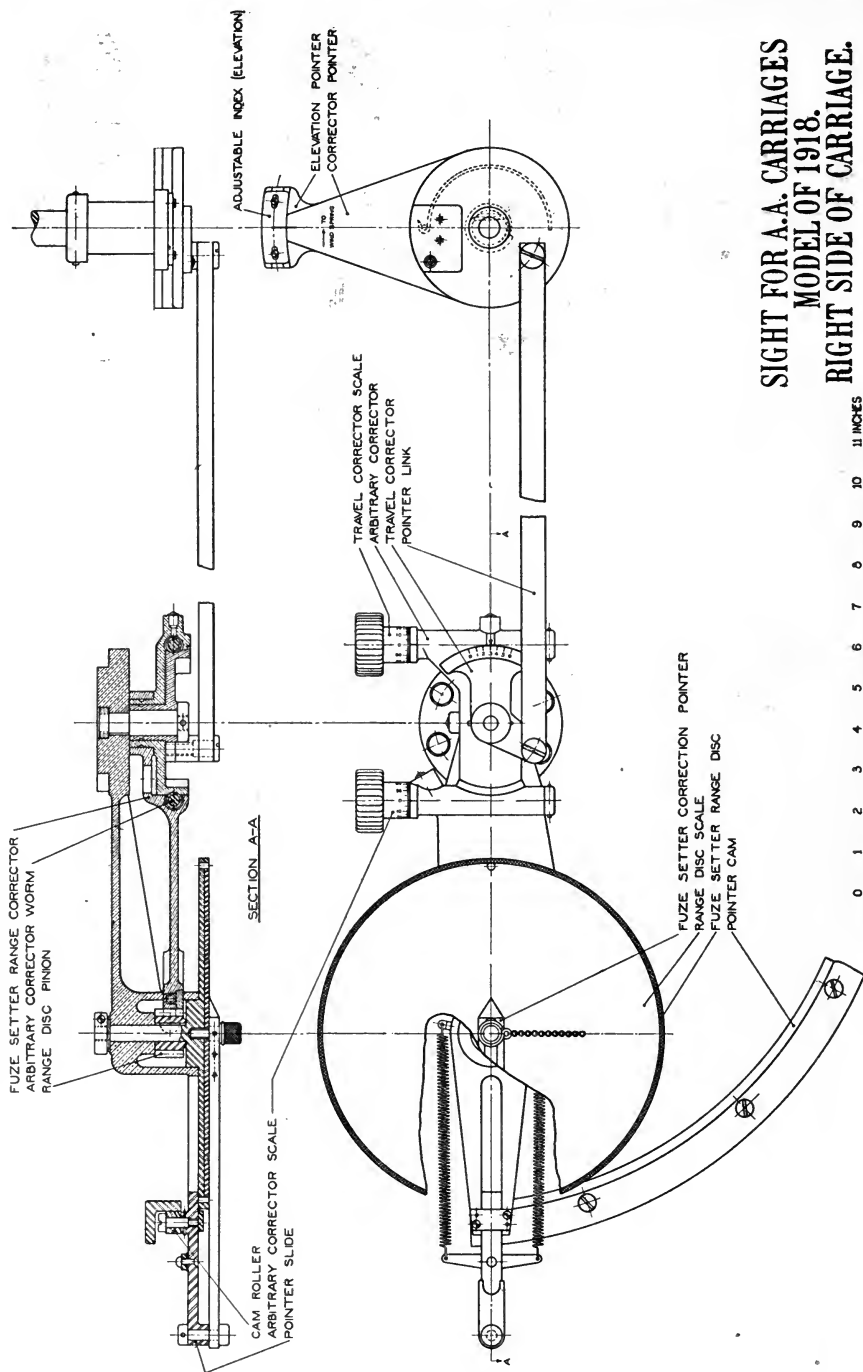

**SIGHT FOR A.A. CARRIAGES
 MODEL OF 1918.
 RIGHT SIDE OF CARRIAGE.**

trailer will actually follow in the path of the truck or tractor by which it is drawn. The trailer may also be steered by the rear wheels when the rear wheel lock is released and the steering bar is inserted. A pintle is provided on the rear end of the trailer to accommodate any vehicles which may be attached thereto.

This vehicle is equipped with a brake of the internal expanding type operating within drums attached to the rear wheels and applied and released by a lever on the right side of the trailer by one of the personnel seated on the ammunition chest.

Weights and dimensions of Trailer.

Wheelbase.....	inches..	156
Width of track.....	do....	60
Length of frame over all.....	do....	200
Width of frame over all.....	do....	48. 125
Weight of chassis.....	pounds..	3, 800
Size of tires.....	inches..	37
Width of tires.....	do....	6
Height from ground to center line of drawbar.....	do....	15
Height from ground to top of frame, empty.....	do....	13
Diameter of brake drum.....	do....	16. 625
Turning radius.....	feet..	28. 6
Road clearance under front axle.....	inches..	10. 281
Road clearance under rear axle.....	do....	11. 375
Height from ground to center line of pintle.....	do....	20. 5
Over-all width at widest part.....	do....	77. 25
Center to center at spring pads, front.....	do....	28. 5
Center to center to spring pads, rear.....	do....	28. 5

The sight issued for anti-aircraft carriages, model of 1918, consists of two units, one being mounted on the right trunnion of the cradle and the other on a bracket attached to the left side of the carriage, the two units being connected by a coupling shaft. The elements on the right side are the range and elevation corrector and those on the left side are the angle of site and deflection corrector. An open sight is attached to the sight proper for rapid location of the target.

All necessary points for night firing are illuminated by the electrical equipment. A 6-volt system is used, the current being supplied by dry batteries, storage battery, or by a manually operated generator. Small lamps of one or two candlepower shielded by reflectors, are used to illuminate the necessary scales and cross hairs.

3-INCH ANTI-AIRCRAFT GUN MOUNT, MODEL OF 1917.

The principle use of anti-aircraft artillery is mainly to hinder aviators from carrying out their missions. The destruction of airplanes, with the means actually at its disposal, is still a question of luck. Experience has taught aviators to defend themselves against fire by continual changes in direction.

The earlier anti-aircraft artillery fire was directed by observation of the burst, but that eventually gave away to direction of the fire by carefully deduced principles. Nevertheless, the anti-aircraft artillery theory lays but little stress upon the possibility of inflicting

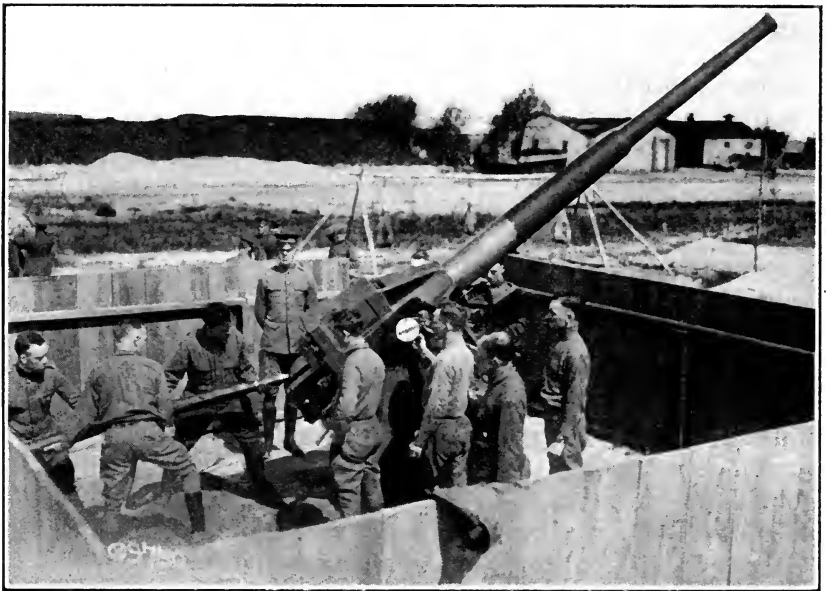

GUN MOUNT IN ACTION.

damage through a direct hit by the projectile which is fired from the gun, as it is considered that the possibility of such hit is too remote. The artillery practice is, therefore, to so direct the projectile that it will explode at a more or less predetermined position and cause damage either by the fragmentation of the projectile, which covers a very much larger volume than the intact projectile, or through the concussion caused by the exploding projectile and whose effects would also be felt through a considerable sphere.

No one type of anti-aircraft gun carriage or mount can possibly satisfy all conditions of modern warfare. It is, however, possible to

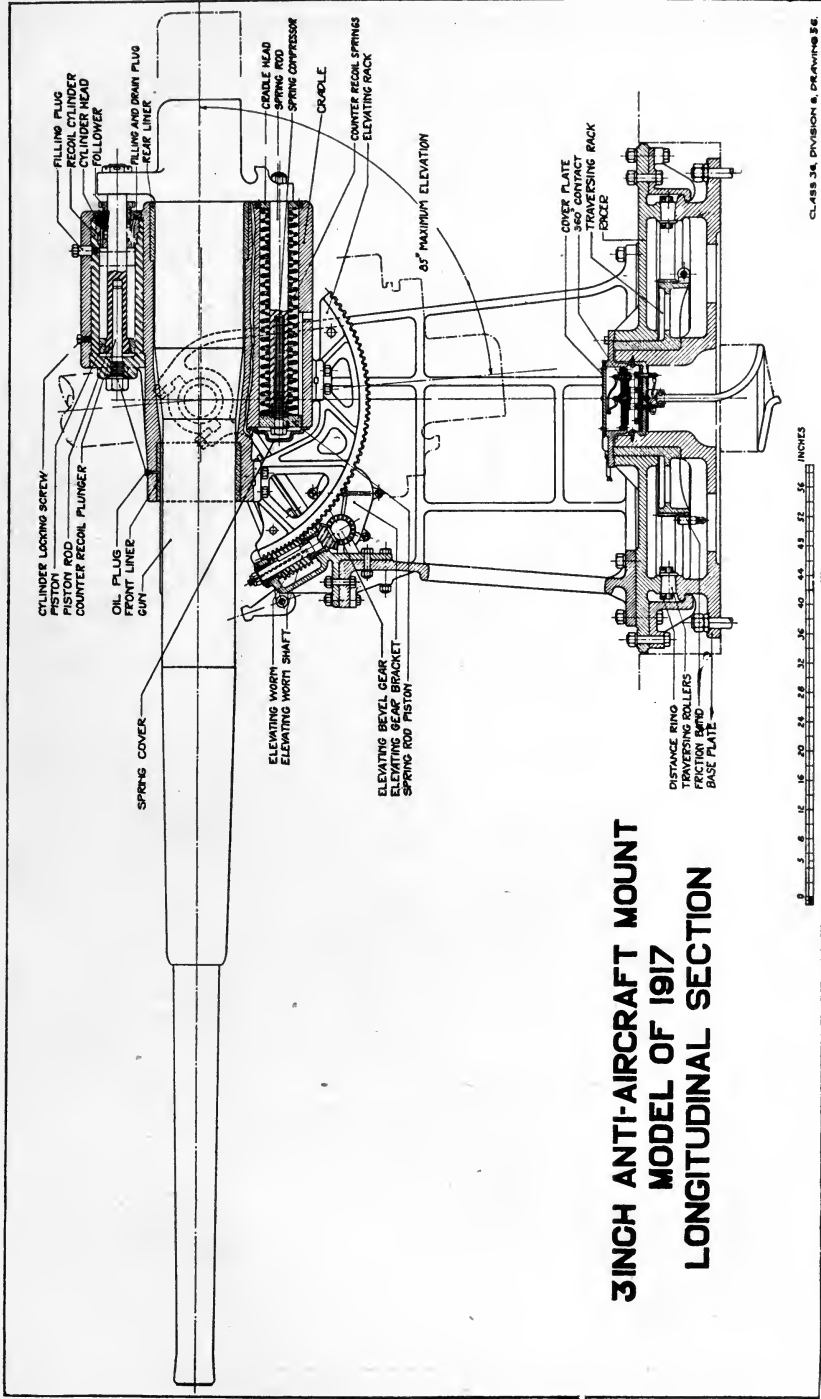

**3 INCH ANTI-AIRCRAFT MOUNT
 MODEL OF 1917
 LONGITUDINAL SECTION**

design a standard gun and top carriage having a wide range of action and by means of interchangeability enabling this mount to be used on either a truck mount, a two or four wheel trailer, a caterpillar tread trailer, or as a semifixed mount, as each of these types of vehicles has its own sphere of action. However, the problem of seacoast defense and for the defense of depots, etc., led to the design of the 3-inch anti-aircraft gun mount, model of 1917.

The 3-inch anti-aircraft mount is of the barbette type, with constant recoil, designed to be mounted on a solid concrete base about



VIEW SHOWING RIGHT SIDE OF MOUNT.

30 inches thick and 18 feet in diameter. The gun mount is designed to mount the 3-inch anti-aircraft gun, model 1917, 1917, MI, or 1917 MII, commonly known as the 15-pounder gun.

The gun has a 12-inch recoil and a muzzle velocity of 2,600 foot-seconds. Both high explosive shell and shrapnel may be employed, the weight of the projectile being 15 pounds, and of the complete round of fixed ammunition being 28.38 pounds.

The gun is mounted on a cradle of the sleeve type, which also serves as a housing for the spring and recoil systems. The cradle is

suspended by the trunnions from the top of the pivot yoke. The pivot yoke is bolted to the racer, which rests and revolves on 30 rollers on the roller path of the base plate. The base plate is held in position in the emplacement by 16 anchor bolts set in the concrete.

The field of fire is 360° , 0° to 90° elevation. Removable stops are provided, however, to limit the elevation of 85° , due to possible injury to the personnel when the piece is fired at a higher angle.

Fixed ammunition is used in these guns, consisting of a time-fuzed high-explosive shell, illuminating shell, tracer shell, and shrapnel. Each round consists of the cartridge case with its primer and powder charge; also the filled and fuzed projectile.

Weights, dimensions, and ballistics.

Weight.....	pounds..	3, 105
Caliber.....	inches..	3
Total length.....	do....	174. 65
Length of bore in calibers.....		55
Length of rifled portion of bore.....	inches..	137. 28
Rifling:		
Number of grooves.....		24
Width of grooves.....	inch..	0. 2927
Depth.....	do....	0. 03
Twist, right hand, 1 turn in 50 calibers at origin to 1 turn in 25 calibers at 9.28 inches from muzzle; thence uniform.		
Weight of projectile, filled and fuzed.....	pounds..	15
Weight of charge.....	do....	5. 32
Weight of fixed ammunition (1 round).....	do....	28. 375
Travel of projectile.....	inches..	139. 33
Volume of chamber.....	cu. in..	296
Muzzle velocity.....	ft. per sec..	2, 600
Maximum pressure per square inch.....	pounds..	32, 000
Maximum horizontal range.....	yards..	12, 755
Maximum vertical range.....	do....	9, 000

The model of 1917 gun is built up of alloy steel, consisting of tube, jacket, and locking hoop. The jacket envelops the rear portion of the tube and forms the recess or seat for the breech mechanism. A recoil lug projects from the upper surface of the jacket near its extreme end and affords a point of attachment for the piston rod of the recoil cylinder. A lug also projects from the under surface, to which are attached the counterrecoil spring rods. The locking hoop is forced on the tube and forward end of the jacket, securing the latter against any rearward movement of the tube under firing stresses.

The model of 1917 MI gun is similar in general construction to the model of 1917 gun, except that instead of the breech ring being integral with jacket, it is a separate piece. The breech end of jacket is threaded to receive the breech ring, which is screwed and shrunk on the jacket and held by a lock screw. The locking hoop is omitted.

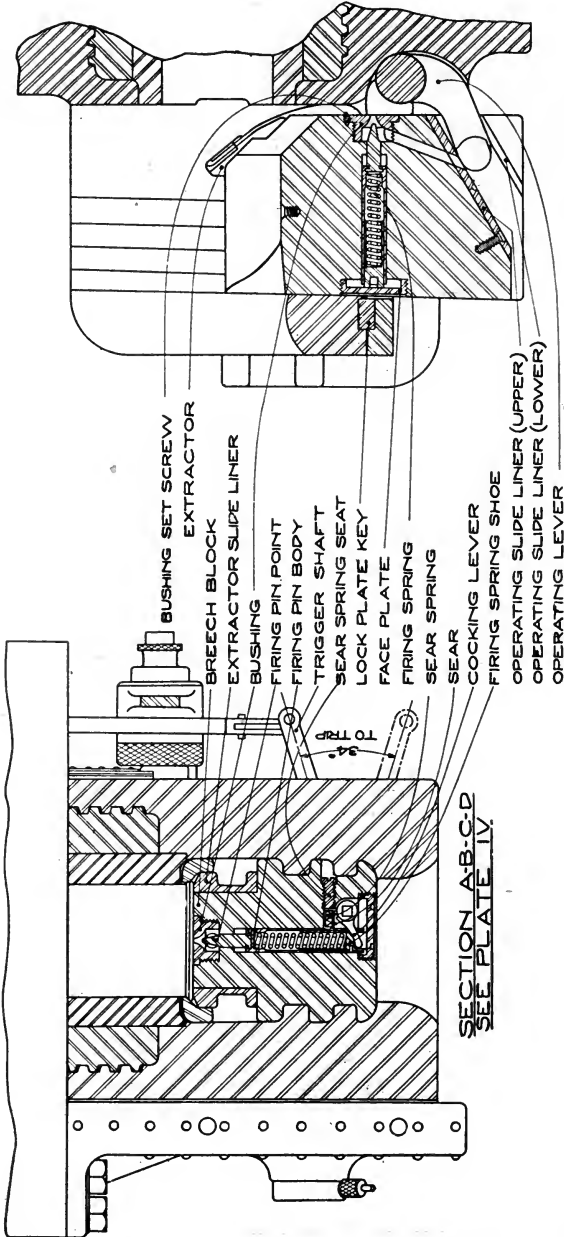

VERTICAL SECTION
 SHOWING BREECH OPEN

The model of 1917 MII is similar in general construction to the model of 1917 MI, except in the method of securing the latch plate to the gun. On the models of 1917 and 1917 M1, the latch plate is secured to gun by screws, while on the 1917 M1 the latch plate is secured to gun by means of a lug.

The breech recess is rectangular in shape. Two extractor trunnion seats, one in each side, are cut to the proper radius for the extractor to rotate and slide. Two holes are drilled from the rear face of the breech, one on each side, to accommodate a spring and plunger which press against the hub of the extractor, keeping it in place and also aids the extractor in ejecting the cartridge case.

The breech mechanism consists of the following parts: Breech block, operating lever, operating handle, operating cam, operating cam cover, trigger shaft, extractors, firing mechanism, latch, and closing spring case.

The breechblock is of the drop-block type and is rectangular in shape. Two grooves run lengthwise on the block, giving a wedging effect against the end of the cartridge case when the block is closed, and when opened insuring a clearance between the cartridge case and the block thus eliminating any chance of the cartridge case jamming. A venthole permits the escape of gas from a ruptured primer.

Two extractor grooves, one on each side of the block, are cut parallel to the guide grooves and curve to a certain cam development which permits the proper action of the extractors. At the top of the block a radius is cut to permit of clearance when inserting the projectile. The toe of each extractor is cut to a radius which will just slide along the body of the cartridge when in place and engage the rim of the cartridge case.

The firing mechanism belongs to that type known as the continuous-pull mechanism; that is, no cocking of the firing pin is required other than a pull on the lanyard or trigger shaft. This arrangement permits of repetition of the blow from the firing pin in case of a misfire, as often as desired without the opening of the mechanism.

Weights, mount, etc.

Weight of mount only.....	pounds..	12, 175
Weight of gun and mount.....	do....	15, 280
Weight of gun and cradle.....	do....	7, 105
Weight of cradle and recoil systems.....	do....	4, 000
Weight of yoke with elevating and traversing mechanisms.....	do....	5, 100
Weight of traversing rack, friction band, roller cage, and base plate.....	do....	3, 000
Weight of sight and supports.....	do....	75

The mount is emplaced in a concrete emplacement, in which 16 anchor bolts are set, and depressions provided for 8 leveling screw thrust plates. A niche for an outlet box, through which electrical connections are made to the main base, or for a storage battery when

generated current is not available, is constructed in the concrete to meet the requirements of the mount.

This emplacement is constructed by the Engineer Corps, which also furnishes and installs the necessary outlet or storage battery and furnishes the plug box portable lamp, cable, and plug.

The principal parts of the mount are the base plate; racer; pivot yoke; cradle (containing recoil cylinder and counterrecoil mechanism); traversing mechanism, including traversing rollers and distance ring; elevating mechanism; firing mechanism; illuminating circuit and sight.

The base plate is a circular steel casting which rests on the concrete emplacement with its upper surface machined to form the lower roller path. Sixteen holes, equally spaced around the circumference of the flange, are provided to receive the foundation bolts which retain the base plate in its proper position in the emplacement. A cylindrical projection in the center forms on its interior the housing for the 360° electrical contact, and on its exterior receives the traversing rack.

The racer is a circular steel plate, upon which the pivot yoke is bolted. The under surface is machined to form the upper roller path, and the upper surface to fit the yoke. The racer rests on the rollers and rotates freely about the hub on the traversing rack. Two clips, front and rear, are bolted to the under side of the racer, and engage with a lug on the base plate to prevent the racer from leaving the rollers, and overturning the mount, when the gun is fired.

The pivot yoke is a steel casting, consisting of two vertical side frames joined in front by a transom. At the top of each frame is a trunnion bearing and trunnion cap lined with bronze bushings. Tapped holes are provided in the left frame for the depression and elevation stop. The distance ring is a circular bronze ring provided with spaces and bearings for the traversing rollers. The traversing rollers, 30 in number, are interposed between the roller paths of the base plate and racer, bearing the weight of the mount. The rollers, roller paths, traversing rack, and pinion are protected from the entrance of dust, sand or grit, by dust guards. The oil grooves on the circumference of the distance ring serve to distribute oil from the holes in the flange forming the base of the yoke to the axles of the rollers. A friction band, resting on the base plate, is made to grip the traversing rack. To adjust this band, which allows slipping of the traversing rack to protect the teeth of the traversing pinion from too heavy a stress, a cover in the base of the yoke is removed, giving access to the parts beneath.

Motion of the mount in azimuth is obtained by a traversing pinion and shaft, the pinion meshing with the teeth of the traversing rack. Power is transmitted from the traversing handwheel to the traversing

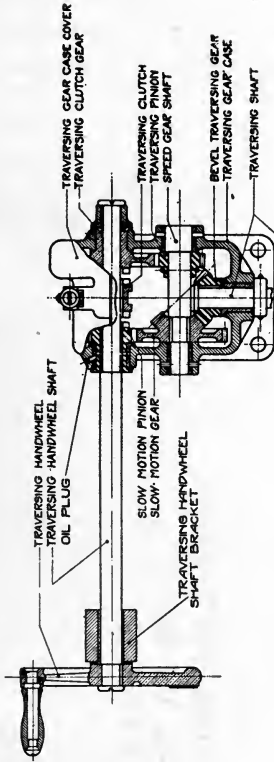

TRAVERSING HANDWHEEL MECHANISM

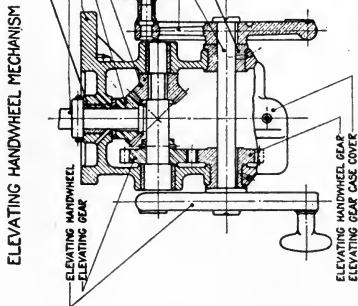

ELEVATING HANDWHEEL MECHANISM

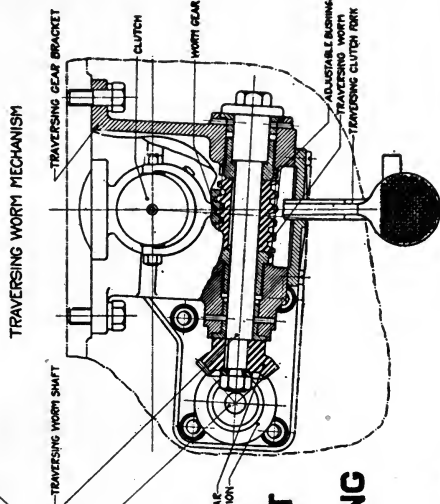

TRAVERSING WORM MECHANISM

3 INCH ANTI-AIRCRAFT MOUNT MODEL OF 1917 ELEVATING AND TRAVERSING MECHANISMS



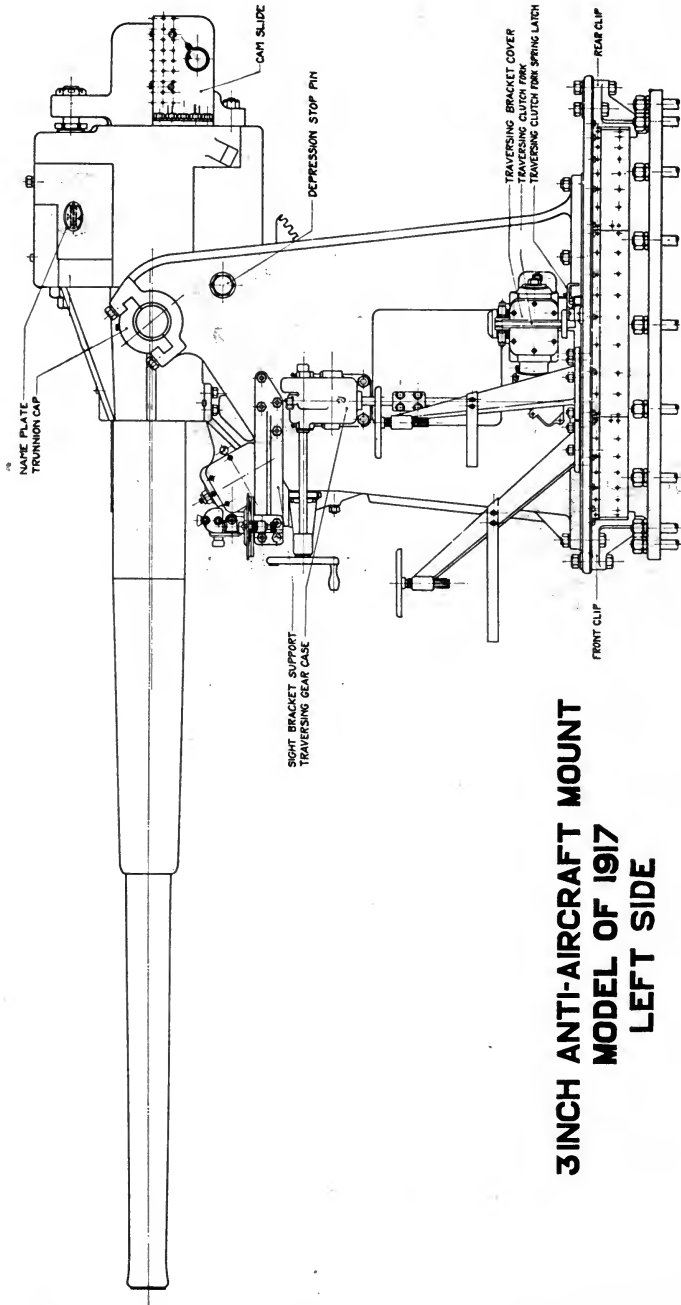

**3 INCH ANTI-AIRCRAFT MOUNT
MODEL OF 1917
LEFT SIDE**

worm, thence to the mount through a set of gears and a clutch mounted in the traversing gear case. Two speeds of traverse are possible upon throwing the clutch in by means of a handle, so that high or low speed gears are connected to the upper traversing shaft.

The elevating mechanism consists of an elevating rack keyed to the underside of the cradle, having on its face teeth which mesh with the elevating worm. The rack is of sufficient length to provide for elevations from 0° to 90° .

The cradle is bored and bushed to receive the gun. Front and rear liners are provided through which the gun slides in recoil. In addition the cradle forms the housing for the recoil and counterrecoil systems. The interior of the cradle has a cored recess to suit the firing mechanism.

Recoil mechanism is of the hydro-spring type. The recoil cylinder is screwed from the front into a seat provided in the top of the cradle. The piston rod is attached to the gun lug at one end and provided at the other end with a piston, slightly smaller than the bore of the cylinder. Three longitudinal throttling grooves are cut in the interior surface of the recoil cylinder, each groove subtending an arc of 30° . With the cylinder in assembled position one groove is located at the bottom. The recoil cylinder has a capacity of $6\frac{1}{2}$ pints of hydroline oil.

Two cylindrical holes bored in the cradle form the housing for the counterrecoil springs. Spring rods are attached at one end to the gun lug and at the other end to the spring-rod piston. When the spring compressor is first assembled it is secured against rotation by a retaining screw. The counterrecoil plunger, designed to check the recoiling parts as they return to battery, passes through the front end of the recoil cylinder and enters the recess in the forward end of the piston rod.

When the gun is fired it recoils to the rear about 12 inches in the cradle, carrying with it the recoil piston and spring rods, thereby compressing the counterrecoil springs. A portion of the energy of recoil is taken up by the resistance the liquid offers to being forced through the variable slots formed by the throttling grooves and the constant clearances between the piston head and the interior surface of the cylindrical bore, the remainder of the energy being absorbed by the springs. The width of the grooves is uniform, but their depth is proportioned so that the areas of the orifices, varying with the position of the piston during recoil, will be such as to give, with the aid of the counterrecoil springs, a constant resistance throughout the length of recoil. The pressure in the cylinder is therefore a uniformly decreasing one.

The counterrecoil buffer is tapered so that the escape of oil during counterrecoil, through the varying diametrical clearances between

the plunger and the hole in the piston, will offer such resistance as will control the motion of the gun during its return to battery position after firing.

The firing mechanism consists of a firing handle whose shaft passes through the center of the right trunnion and carries on its inner end a lever which operates the firing shaft. Previous to the firing the gunner pulls the firing handle which compresses the cocking spring solid and moves the lever on the breech to the tripping position; the gunner will know when the mechanism has reached this position by feeling the increased pressure exerted by the firing spring. To fire the gun, the gunner pulls the firing handle, compressing the firing spring, thus tripping the firing pin. The two-stage movement of the firing handle is intended to permit a shorter movement at the moment of firing.

The illuminating circuit has a 360° contact mounted in the base plate. Direct-current mains of either 110 or 220 volts are connected with an outlet box located in the concrete emplacement.

Two circuits are led from the 360° contact, one leading to the plug box for use as a portable lamp of line voltage, and the other circuit leads to the switch box; from here it is led to the rheostat from which two branch feeders are taken to the two receptacle boxes and bolted to the yoke. A circuit is taken from the right receptacle box with a spliced branch feeder to a candelabra receptacle for the reticule lamp and deflection pointer lamp. Another circuit is run from the left receptacle box with two spliced branch feeders to a candelabra receptacle for the elevation pointer, range disk pointer, and elevation correction lamps. These lamps are supported by lamp brackets fastened to the trunnion and sight mechanism.

The rheostat used cuts down the voltage and makes the use of low-voltage lamps and batteries practicable in case the line voltage fails through accident.

The cable leading from the 360° contact with the plug, switch, and rheostat is of the twin conductor, leaded, and armored type. The two branch feeders leading from the rheostat to the receptacle boxes and thence to the lamp brackets are of the portable conductor type. The various cables are fastened to the mount by means of cable straps and twisted hooks.

Sight for anti-aircraft mount, model of 1917.—This instrument includes all parts used to direct the elevating and traversing of mount so that the gun may be pointed properly in elevation and direction. The parts consist of a sight proper (telescope), the sight mount, range disk, correction scale, and pointer. For any visible target the data necessary to properly lay the gun consists of fuse-setter range, travel in elevation and deflection, and the required arbitrary correction.

The target is brought into the field of view by turning the azimuth and the angle-of-site knobs, imparting to the sight a movement in azimuth and elevation, respectively.

A scale is provided whereby the sight proper may be set in elevation at any desired angle, whence the gun by means of the elevating mechanism is also elevated to the same angle (corrections being zero).

An azimuth scale is also provided between the fixed and rotating parts of the carriage so that the gun by means of the traversing mechanism may be set at any desired angle in azimuth.

75-MILLIMETER ANTI-AIRCRAFT TRUCK MOUNT.

(MODEL OF 1917.)

To appreciate the difficulty of anti-aircraft fire it suffices to consider that one is firing practically at a bird whose velocity is about 50 meters per second, i. e., one-sixth the average velocity of the projectile itself in the case of the 75-millimeter field gun. The principal result hoped for by the anti-aircraft artillery fire is to prevent airplanes from accomplishing their mission by obliging them to fly at increasing altitudes, to continually change their direction, and also to prevent their crossing certain regions.

At the present time the anti-aircraft artillery aims to keep airplanes beyond the limit of their range. Observation airplanes are obliged to fly out of range, reconnoitering airplanes continually increase the



TRUCK IN TRAVELING POSITION (RIGHT SIDE VIEW).

height at which they cross the lines, and battle planes must also fly very high, except when they wish to attack trenches or batteries with machine guns. Raids of this kind are almost exclusively carried on at night. The result is that three kinds of fire have become particularly important:

Fire against airplanes at a great range and a great height.

Fire against very speedy airplanes attacking positions.

Fire at night against bombarding airplanes.

The need of an anti-aircraft weapon to meet the above requirements led to the design of the 75-millimeter anti-aircraft truck mount. This development involved the use of an American model 1916 field gun, equipped with a hydro-spring recoil mechanism having throttling

valves cut in the cylinders. This gun and recoiling mechanism is secured on an offset swivel gun mount, suitably mounted on a 2½-ton White gasoline-driven truck, Model TBC, designed to receive the base plate of the top carriage.

The gun (see p. 72) is carried on a cradle which rocks in elevation about the trunnions of the top carriage, and, by means of the elevating mechanism, a range of elevation from 31° to 82° is obtainable. The piece has a recoil of 33 inches on its cradle and is provided with a recoil cylinder, counter-recoil springs, and buffer.

The piece has a muzzle velocity of 1,830 feet per second, and uses high-explosive and shrapnel shells, the former weighing 14.7 pounds and the latter 14.3 pounds, employing a 20-second (maximum) time fuze with each. With a maximum vertical elevation of 82° a vertical bursting ordinate of 5,980 meters is obtained, and with the minimum elevation of 31° a vertical bursting ordinate of 1,750

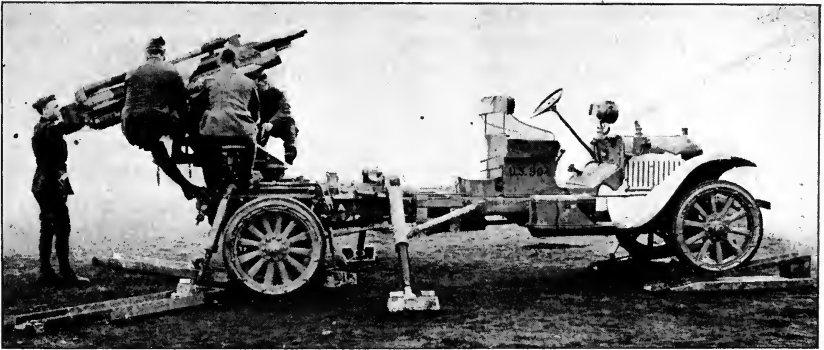

VIEW SHOWING TRUCK MOUNT IN ACTION.

meters is obtained. In both cases the bursting ordinates were limited by the time fuze.

The gun with the breech is located directly behind the driver's seat, but as the length of recoil is fixed, the firing position is limited to such horizontal position of the mount as would permit of the gun recoil clearing the sides or rear of the truck chassis.

A heavy base plate is secured to the rear end of the chassis, and the top carriage swings in azimuth about a central pintle bolt on rollers. By means of the traversing mechanism, the carriage, carrying the gun and its corresponding mechanism, can be traversed through 240°, which is the field of fire. The chassis is equipped with firing and stability jacks to relieve the rear springs and truck of all firing strains. With the jacks properly placed and leveled, the vehicle is supported on a rigid horizontal platform formed by the firing jacks and the base plate. When in action the stability equipment functions to prevent the mount from overturning when the gun is fired at low angles of elevation.

Weights, dimensions, and ballistics.

Caliber	inches	2. 953
Total length of gun	do	90. 9
Length of the rifled portion of the bore	do	72. 72
Length in calibers	do	28. 4
Weight of projectile:		
Shell	pounds	14. 7
Shrapnel	do	14. 3
Weight of full powder charge	do	1. 625
Service muzzle velocity	feet per second	1, 830
Horizontal range at 45° elevation (14.3-pound shell)	yards	10, 595
Maximum elevation	degrees	82
Minimum elevation	do	31
Total traverse	do	240
Weight of gun and breech mechanism	pounds	750
Weight of gun, breech mechanism, and carriage	do	3, 300
Weight of chassis, including attachments and accessories	do	4, 500
Weight of top carriage, and its corresponding mechanism, etc	do	4, 250
Total traveling weight of unit (fully equipped)	do	9, 500
Overall length of vehicle (traveling position)	inches	209
Overall width of vehicle (traveling position)	do	74½
Weight of chassis only (without attachments)	pounds	4, 100
Wheel base	inches	157½
Wheels, front	do	36 x 4
Wheels, rear	do	36 x 7
Road clearance	do	9½
Rating of load	tons	2½
Tread	inches	62

The principal parts of the carriage are: The base plate, top carriage, recoil mechanisms, cradle, elevating and traversing mechanism, angle of sight mechanism, firing jacks, stability jacks, and rails.

The base plate is a rectangular steel casting secured to the truck chassis, and serves as a support for the top carriage. The traverse of the top carriage is limited by lugs provided on the top of the clip surface. The clip prevents the traversing rollers from leaving their path due to the shock caused by action of recoil or counterrecoil. Four lugs radiating from the pintle bearing serve as points of attachment for the firing jacks and rail tie rods. At the forward end of the base plate are two lugs, one on either side, which project out at right angles to the truck chassis, serving as points of attachment for the stability jacks. The firing strains produced during action are transmitted through these lugs and jacks, thus eliminating all unnecessary strains from the rear springs and wheels of the truck.

The top carriage is a steel casting, comprising a base and two vertical side frames designed to mount the cradle to permit sufficient clearance for the recoiling parts at high angles of fire. A pintle bolt projecting from the base plate through the case of the top carriage forms an axis about which the carriage is rotated in azimuth upon four rollers resting on the roller path of the base plate. Between the two side frames is housed the angle of sight mechanism. The traverse of the carriage

is limited to 240° by means of a traversing stop plunger, which engages the lugs on the clip surface. When preparing for travel the stop plunger can be raised to clear the limit stop, thus permitting the proper position of carriage when en route. Four seats (two on each side) riveted to swinging arms, for the use of the cannoneers during action, are secured to the top carriage.

Recoil mechanism.—The recoil mechanism is of the hydro-spring type, with recoil cylinder mounted above the gun. Three longitudinal ribs, or throttling bars, of uniform width but varying height, are formed on the inside of the cylinder and engage with corresponding grooves in the piston head. The clearance between the bars and grooves determines the amount of oil which may pass from the back to the front of the piston head, thereby regulating the amount of recoil.

The piston rod is a hollow steel tube and is fitted with a bronze head. The rear end of the piston rod is bored out to accommodate the counterrecoil buffer, which fits into the bore with a small clearance. This clearance depends on the taper of the buffer, as the hole in the piston rod is of constant diameter.

In each spring cylinder, three coils of inner and outer counterrecoil springs are assembled over the spring rod. The inner and outer springs are wound in opposite directions to prevent nesting, and each pair of inner springs is separated from the next pair by a bronze separator.

When fired, the gun moves back on its slides carrying with it the recoil cylinder and counterrecoil springs. The piston rod is secured to a nonrecoiling part of the carriage, thus when the recoil cylinder moves to the rear, the oil in it must pass from one side of the piston to the other. The energy of recoil of the gun is absorbed by the resistance which the oil offers to being forced through small openings past the piston, also by the compression of the counterrecoil springs. The energy stored up by the springs returns the gun to battery position. The return movement is eased and regulated by the counterrecoil buffer, which prevents any undue shock to the recoiling parts by offering resistance due to the fluid in the hole of the piston rod being forced out as the buffer gradually enters the hole.

The cradle comprises the counterrecoil spring cylinders with their component attached parts. The spring cylinders are below the gun and in the form of two cylinders joined at the center. Above the cylinders are the bronze lined gun ways or slides. The trunnions are secured to the cylinders, and the elevating arc is bolted to lugs on the bottom. Riveted to the right side of the cradle is the elevation stop and the depression stop.

The rocker, a U-shaped forging, is journaled upon the trunnions. Bearings are provided in the bottom of the rocker for the elevating mechanism and a rack is cut on the exterior of its yoke for the angle of sight worm.

The traveling lock is located under the rear end of the spring cylinder. This device functions to lock the cradle at an angle of approximately 32° in elevation when preparing for travel, thus the elevating angle of



GUN MOUNT SHOWING GUN AT MAXIMUM ELEVATION.

site and traversing mechanisms are relieved of all unnecessary vibrations when the vehicle is en route. At the front end of the base plate is hinged a lock bar and brace, which engage a lug provided on the rear

end of the cradle. In order to bring this lug in proper position to receive the lock bar, the cradle must be traversed to its traveling position, that is, to bring the axis of the gun into a vertical plane with the center line of the truck chassis.

The elevating mechanism consists of an elevating worm, an elevating arc or rack, and a train of miter gears mounted on the right side of the rocker. The shaft on which the elevating handwheel is mounted extends through the side frame of the top carriage.

The worm is operated through gears and a shaft by means of a handwheel, and rotates the cradle about the trunnions. Any movement imparted to the worm by the handwheel will cause the cradle to move with relation to the top carriage. One turn of the handwheel will cause the gun to be elevated or depressed approximately

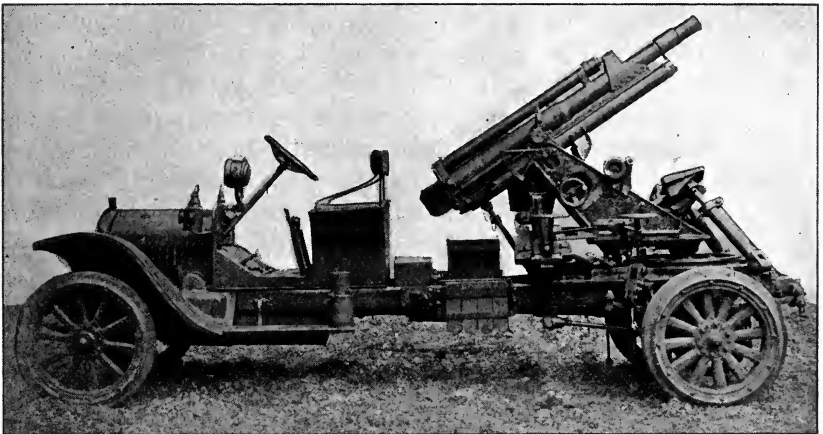

TRUCK IN TRAVELING POSITION (LEFT SIDE VIEW).

1.7°. The elevating arc permits a change of elevation from 31° minimum to 82° maximum.

The traversing mechanism located on the left side of the top carriage, consists mainly of a traversing handwheel and shaft, worm, worm wheel, clutch, bevel pinion, traversing pinion, and rack. The worm engages the worm wheel and can be either engaged with or disengaged from the shaft by means of a clutch operated by a foot lever. If the clutch be disengaged, the worm and worm wheel are released from the gear train, and the top carriage may be traversed about the pintle bolt by hand. The traversing pinion engages the traversing rack which is secured to the base plate. One turn of the handwheel will cause the gun to be traversed approximately 2°.

The angle of site mechanism consists of a handwheel, handwheel shaft, and angle of site worm. The angle of site worm is secured to the top carriage and engages in a rack cut in the face of the yoke of the rocker. To one end of the shaft which extends out to the right

side of the top carriage is secured the handwheel and to the other end is fixed a miter gear.

The angle of site worm is a one-piece forging comprising a worm, a shaft, and a miter gear of the same size as that on the bracket at an angle of 90° to the handwheel shaft and with the miter gears at the ends in mesh. One turn of the handwheel will cause the rocker and the cradle to be elevated or depressed approximately 25 mils. The rocker allows a correction of 124 mils depression and 200 mils elevation.

Firing and stability jacks.—The principal parts of the firing jacks are the jack body, jack screw, foot, and spade. There are two firing jacks, the bodies being hinged at the rear corners of the base plate as shown on page 363. At the end of the jack screw the foot, or float, is secured by a ball joint which enables the jack to be seated on inclined surfaces. The foot is provided with a sharp-pointed spade, which is driven into the ground. A tie rod is used between the two jacks to keep the jack bodies from spreading out when the load is put on the screws. The firing jacks act as rigid supports for the base plate at the rear corners, and relieve the truck chassis of firing strains.

The stability jacks are essentially the same in construction as the firing jacks, but heavier. Their function is to prevent the overturning of the truck when the gun is fired at low angles of elevation, and also to take the firing strains. The stability jacks are hinged to the base plate, one on each side and each is supported by a strut hinged in a lug secured to the truck chassis. The stability jack floats are provided with spades.

When the carriage is in the traveling position, the firing jacks and stability jacks are folded up and secured by chains. The spades are removed and placed in receptacles provided on the chassis. The stability jack struts are unpinned from the forward lugs, removed and carried in holders on the base plate. The tie rods are folded with the jacks and chained in position.

Two stability rails and tie rods are provided with each mount, one being straight and the other having an offset. They are crossed under the rear axle of the truck, the rear ends being located so that the firing jack floats set in the spaces between the angles of each rail. The middle angles at the front ends of the stability rails are attached to the stability rail tie rods, which in turn are connected to the adapters on the lugs, directly opposite the firing jack lugs, on the base plate.

When the vehicle is to be emplaced, both of the truck wedges are placed on the ground with the channel side up, and the front wheels of the truck are run up the channels between the flanges. The purpose of these wedges is to raise the front end of the truck so that the mount will be level when the rear end is jacked up. Two steel blocks are provided for blocking the front wheels when they are run up on the truck wedges.

Rear axle slings.—When traveling, the slings hang loosely under the truck, one on either side of the transmission. The front ends of the slings are looped around through holes in the base plate and clamped in place permanently. Two steel rods are inserted in the rear loops of the slings and placed across the rear end of the chassis when the mount is emplaced, and two pieces of pipe are inserted in the front loops of the slings and placed across the ribs on the front end of the base plate. The purpose of these slings is to keep the



FIRING AND STABILITY JACKS.

rear springs compressed and the rear wheels off the ground when the mount is jacked up.

The electrical equipment consists of five lamps receiving current from a storage battery, suitable wiring, and switching arrangements.

Two three-cell, 6 to 8 volt batteries are provided, one for reserve, each of 120-ampere-hour capacity, and are carried in a metal container which is bolted to the chassis of the truck. One battery, when fully charged and in good condition, will furnish energy for about 24 hours' continuous service for all lamps.

All wiring is permanent and the connecting wires are protected by steel armor wherever mechanical injury is likely. Should it be necessary to remove the top carriage, the lead from the battery which runs through the pintle bolt may be disconnected above the top of the bolt by unwrapping the insulation and opening the connecting plug there provided.

The lamps are specially designed to withstand the shock of firing and are rated at 2 candlepower. One lamp is provided for illuminating each of the following parts:

- Deflection correction pointer.
- Reticule.
- Elevation pointer.
- Range disk pointer.
- Elevation correction pointer.

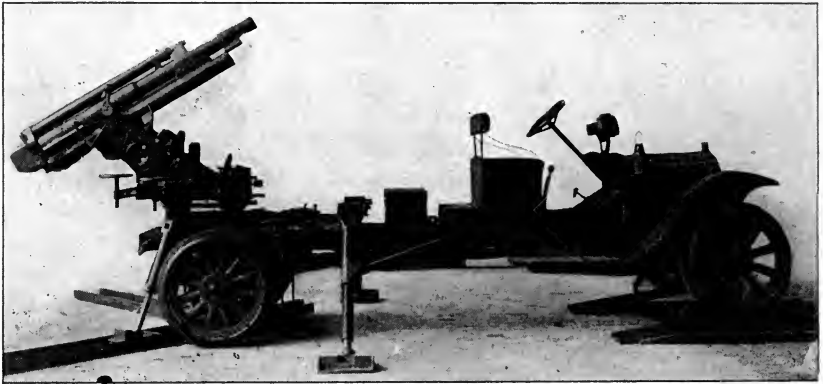

TRUCK MOUNT IN BATTERY POSITION.

A snap switch is provided in the main battery lead which controls all the lamps, and the lamps should be disconnected by means of this switch when not in use.

The sight for this anti-aircraft vehicle is an instrument which includes all parts used to direct the elevating and traversing of the mount so that the gun may be pointed properly in elevation and azimuth. The parts consist of a sight proper (telescope), the sight mount, range disk, correction scale and pointer. For any visible target, the data necessary to properly lay the gun consist of fuze setter range, travel in elevation and deflection, and any desired arbitrary correction.

The object is brought into the field of view by turning the azimuth and the angle of site knobs imparting thereby to the sight a movement in azimuth and elevation respectively. The object is followed by continuing the movement of these knobs. Detailed description of the model 1917 anti-aircraft sight may be found in separate pamphlet covering fire-control instruments.

TRENCH WARFARE MATÉRIEL.

The trenches constitute the most advanced position of a combat army and the equipment and supplies placed at the disposal of those occupying them are generally classified under the broad heading of "Trench warfare matériel."

The trench forms protection against horizontal firing and permits of secret massing of troops for surprise attacks, and it is the constant aim of the Air Service, with its photographic equipment and telegraphic communications, to reduce this element of surprise. Concealment of the general outline from airplane observation is impossible, but details may be concealed, for an observer in an airplane can not see whether a trench is occupied unless the airplane flies dangerously low.

The trenches are carried up to within 200 yards or less of the enemy's front line and are the scene of constant watchfulness to prevent enemy advance and of constant attempts to reduce the enemy personnel, lower his morale, capture prisoners for the purpose of obtaining information, and to advance the position of our own lines.

The field artillery is located from 1 to 5 miles or more behind the front line, in order to protect it from sudden rushes by the enemy, while the infantry, machine gun, and trench mortar personnel occupy the trenches interlaced through the intervening terrain to afford this protection and also to place the personnel of the army in a position to come into contact with the enemy without being obliged to pass over a wide intervening stretch of terrain under enemy fire.

The operation of all branches of the service are interrelated, and nothing is haphazard or independent of the comprehensive plan, save during the heat of action or in the event of units becoming isolated, and such movements are temporary only in their independence, as their effects are consolidated with the complete plan so soon as opportunity permits. The air service, field artillery, the signal service and the tanks are all coordinated through headquarters with the service of the trenches and communication is maintained through an elaborate system of telephone and telegraph wires, pyrotechnic flashlights, flare, or other visual signals.

The trench system includes a front-line trench of broken line formation, whose individual straight lines are from 9 feet to 18 feet in length. An enemy entering this trench can sweep only the length of

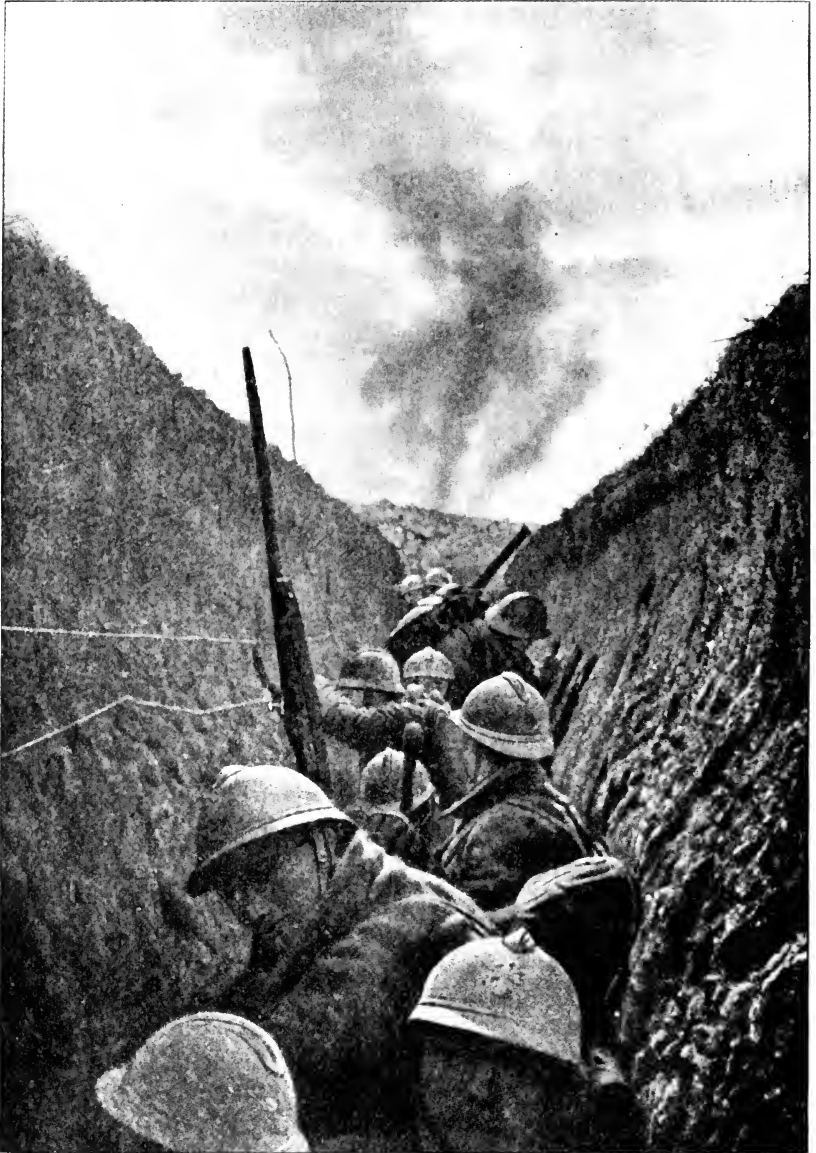

TRENCH WARFARE.

the straight line, and must fight around a barrier for the balance of the trench. This trench is connected by communication trenches to a supervision trench located to the rear, and thence by other trenches, possibly several miles further back, into friendly territory. The communication trenches are curved, elbowed or zigzagged and have T or L connections, island pockets, tunnels, bombing pits, strong points, keeps, shelters, dugouts, or other provisions as the conditions may demand.

Traps are arranged for the confusion of an enemy entering the trench, positions are arranged for dropping barbed wire, knives, or frames quickly into position to retard the advance of the enemy troops who have gained the trench. Machine gun and mortar emplacements are built where needed and bomb-proof dugouts provided for rest quarters, storage and forward dressing stations for the treatment of wounded.

The narrower a trench is the better the cover which it affords. Communicating trenches are made of sufficient width to permit of



ARRANGEMENT OF TRENCHES.

the carrying of stretchers, and thus allow for the evacuating of the wounded during daylight. The wider trench submits it to greater effect from enemy artillery fire, but if trenches are not wide enough for stretchers, losses result through the detention of casualties in the trenches until darkness permits of their removal to dressing stations. The wider trench also permits a more rapid movement of men and supplies between the front line and rear areas, and thus reduces the time during which men and supplies are detained under concentrated fire, and hence reduces the casualties and destruction from this cause.

Gas is a constant menace in the trenches, as it is heavier than air, and its effects vary with the nature of the gas employed. Flame or liquid fire is employed both with a view to inflicting injury to the enemy and lowering his morale. The presence of water is always taken into consideration, for the trench is open to water resulting from rainfall. Provisions are made for footing and drainage, advantage being taken of natural slope where possible.

Trench warfare has shown the necessity for hurling large charges of high explosives for comparatively short ranges. This necessity has led to the development of the trench mortar, a type of weapon that is a short smooth bore of simple construction. They are muzzle loaders and use as their projectile a thin-walled shell, known as a trench-mortar bomb.

In trench warfare the rôle of trench artillery is to harass the enemy by engaging living targets where opportunity offers, to attack and destroy enemy defensive works and obstacles within range limits, and to prevent the construction of new works.

The trench mortar is essentially a trench artillery weapon of limited range which will render very efficient service when properly emplaced, skillfully handled and served.

The trench mortars are divided into three classes, light, medium, and heavy calibers.

The light trench mortar is very mobile. Its effect against material is inconsiderable, but is particularly effective against massed troops, or troops driven into the open, due to its rapidity of fire. These mortars are used to form a barrage behind the hostile line to prevent reserves and ammunition being brought up. Owing to their high mobility, limited only by the difficulty of ammunition supply, they are especially fitted to accompany the infantry as it advances, and are used to attack machine-gun shelters and other points which have temporarily checked the forward movement of the infantry.

The medium trench mortar, with its range of approximately 1,200 meters, is very effective against wire entanglements, machine-gun shelters, strong points, trenches, and other similar objectives not too strongly protected.

The heavy trench mortar is designed for the attack of heavily protected shelters and dugouts, trenches, machine-gun shelters, and strong points. It is seldom used against wire entanglements because of the large crater formed by the explosion.

In most types of trench mortars the propelling charge is carried at the base of the bomb and is ignited by striking a pin at the breech of the piece. The bomb is dropped into the muzzle and slides down by its own weight until the firing pin ignites the charge.

The types now issued to the service are:

3-inch Stokes trench mortar, Mark I.

6-inch trench mortar, Mark I.

The characteristics of each type will be discussed on the following pages.

3-INCH STOKES TRENCH MORTAR (MARK I).

The 3-inch Stokes trench mortar is of British origin, and proved a very useful and excellent weapon owing to its simplicity, light weight, and the principle of auto-ignition. Its principle has practically been



3-INCH STOKES TRENCH MORTAR, MARK I, SHOWING MORTAR IN ACTION.

copied by both the French and our armies and applied to other mortars.

The mortar essentially consists of the following components: A smoothbore barrel, a bipod, and base, the complete unit weighing 108 pounds. The barrel is a seamless drawn steel tube, lapped to

size and necked down at one end and called the breech or base end. To the breech end is fitted a base cap, within which is secured a firing pin protruding into the barrel. The barrel is supported near the muzzle end, by a steel bipod fitted with elevating and traversing screws. The recoil of the mortar is taken up by a base plate against which the base cap of the barrel rests.



FRONT VIEW OF TRENCH MORTAR.

The elevating stand is made of tubular steel, consisting of two legs attached to a center trunnion by means of a compass joint; these legs are held apart by a cross stay which is arranged to spring just past the dead center in such a manner as to hold the two legs rigidly apart. The trunnion standard is fitted with a pair of bevel gears operated by a handle, by means of which the elevating screw can be rapidly raised or lowered. The upper end of the elevating screw is fitted with a yoke to support the transversing screw shaft, which,

together with a traversing handle and a dog clutch, forms a bolt and is held in position by a locking pin. A traversing screw carried by the traversing screw shaft and driven by the dog clutch forms the means of traversing the mortar by engaging a nut fixed to the barrel. The barrel can be quickly disconnected from the mounting by lifting the locking pin and withdrawing the traversing bolt. The barrel may then be lifted out of position.

The base plate has three depressions. The shape of the base cap permits the lower end of the barrel to rest in any of these depressions, and by shifting the barrel from one to another a change of 6°



REAR VIEW OF TRENCH MORTAR.

in direction of line of fire can be made on either side of the center position.

In firing position the base plate is embedded in the ground at about a 45° angle. The lower end of the barrel is placed in the indentation in the base plate which gives the barrel the direction nearest to that desired, the upper end of the barrel being supported by the legs of the bipod. Minor adjustment for direction is secured by means of the traversing screw. The barrel is then given the elevation corresponding to the desired range by operating the elevating screw. The range quadrant (or clinometer), being set for the desired range, indicates when the barrels has the proper elevation.

The shell or bomb used with this mortar is a cylinder loaded with high explosive, fitted at its head with a detonating fuze. The weight of the shell is approximately $11\frac{1}{2}$ pounds. The propelling charge consists of 12-gauge shotgun shell, which fits in a cartridge container at the rear end of the shell. To secure additional range, 1 to 3 rings of ballistite can be placed around the cartridge container. The range secured with cartridge alone varies from 150 yards at 75° to 300 yards at 40° . With cartridge and three rings, the range reaches a maximum of 750 yards at 40° elevation.

The firing operation is as follows: The shell with propelling charge in position (the cartridge inserted in the cartridge container and the rings around the container) is dropped into the muzzle of the mortar, cartridge end first, and slides down the barrel. The primer of the cartridge is fired on impact with the firing pin. Ignition of the ballistite rings is obtained from the flash of the cartridge through ports in the cartridge container. The shell, carrying the cartridge case with it, is projected from the barrel and the mortar is ready for another shell.

The extreme rate of firing under average conditions is about 25 rounds per minute, but 10 rounds per minute is considered the average effective rate. The crater formed by the shell has a depth of about 2 feet and a diameter of about 4 feet.

Weights of mortar.

	Pounds.
Barrel, ring, clamp, traversing screw, and base cap-----	43
Bipod (mounting complete)-----	37
Base plate-----	28

6-INCH TRENCH MORTAR (MARK I).

This mortar is an American adaptation of the British 6-inch Newton trench mortar. It is operated by dropping the shell down the barrel of the gun and thus igniting the propellant. While the principle of firing is the same as in the 3-inch Stokes mortar, the mounting is somewhat different, in that no bipod is employed; the breech end of the barrel resting on a cupped base plate and being supported in an overhanging position therefrom by three guy rods. This weapon is a most effective agent against machine-gun nests, barbed-wire entanglements, fortifications, etc., but is seldom used against personnel.

This mortar consists of the following essential components:

Barrel with clinometer.

The platform, base, guys, and fittings.

The sub-base.

The barrel is of one piece, muzzle loading, having a smooth bore. The breech is closed and rests in a hemispherical socket supported upon a stationary platform to which the barrel is stayed by three adjustable guys. The elevation, which varies from a maximum of 75 to a minimum of 40°, and lateral deviation is made by altering the length of the guys, which are adjustable by means of handwheels. These adjustments are determined by the setting of the clinometer attached to the barrel. The range can be varied by changing either the elevation of the gun or the weight of the propelling charge.

The setting up of this mortar is a more elaborate proceeding than the setting up of the 3-inch Stokes mortar. The cast steel base is bolted to a hardwood platform, which is mounted on a sub-base made up of timbers and a rectangular iron frame bolted together. The sub-base may in some cases be dispensed with, as shown on page 373.

The barrel is furnished internally at the breech end with an axial firing pin or anvil and externally with a guide stud and a misfire plug. Should the ignition cartridge fail to function when the shell is dropped down the barrel, the misfire plug permits of the introduction of a small powder charge with fuze for the ignition of the propelling charge. Graduations are engraved on the barrel on the right and left of a zero line and are used for traverse setting of the clinometer.

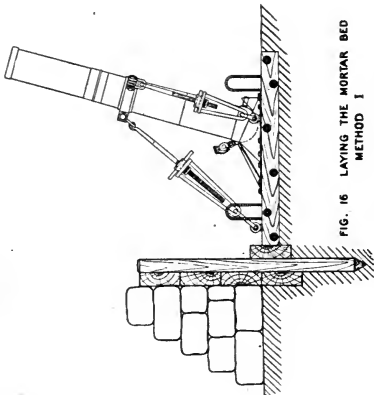

FIG. 16 LAYING THE MORTAR BED METHOD I

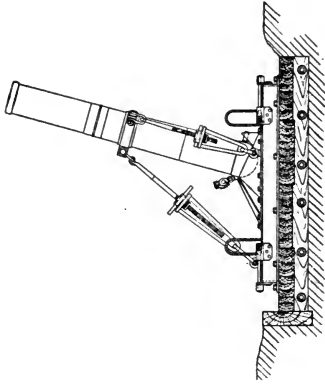

FIG. 17 LAYING THE MORTAR BED METHOD II

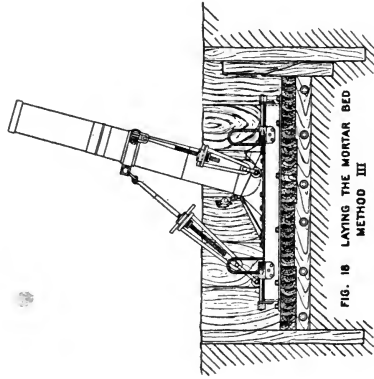

FIG. 18 LAYING THE MORTAR BED METHOD III

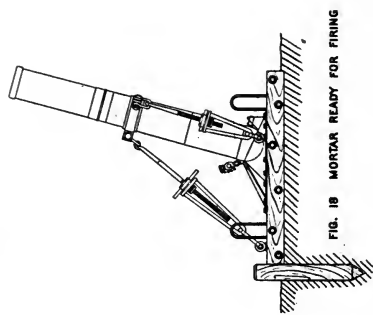

FIG. 19 MORTAR READY FOR FINING

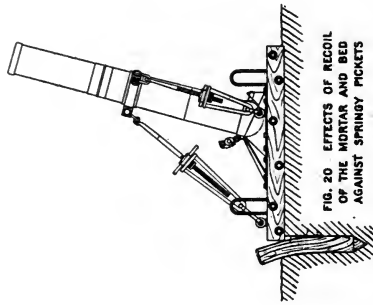

FIG. 20 EFFECTS OF RECOIL OF THE MORTAR AND BED AGAINST SPRINGY PICKETS

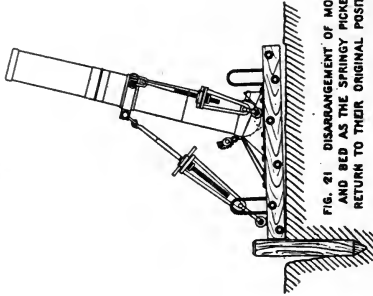

FIG. 21 DISARRANGEMENT OF MORTAR AND BED AS THE SPRINGY PICKETS RETURN TO THEIR ORIGINAL POSITION

The base is a steel casting having a machined hemispherical socket on the upper side to receive the rounded end of the barrel and provided with a guide groove which engages the guide stud on the barrel when in position.

The base is bolted to the hardwood platform. Elevating and traversing guys are anchored to the upper side of the platform, while the free ends of the guys are hooked into clevises on the barrel when the latter is mounted on the base. Special hooks provide a method



LEFT SIDE VIEW OF 6-INCH TRENCH MORTAR.

of fastening the guys during transportation. Four wire-rope handles are provided as a means for carrying the platform.

The clinometer consists of a quadrant graduated with an elevation scale and straddled by a bubble carrier which oscillates about a center on the quadrant. The bubble carrier is provided with a pair of cross bubbles. The clinometer is attached to the mortar barrel by steel bands and a clamping screw.

In laying of the piece, an arrow on the quadrant is set to coincide with the desired traverse and the indicator on the bubble carrier is also set coincident with the desired elevation. The guys are then

adjusted so that both bubbles are exactly level, the barrel of the gun in the desired direction.

The gas ejector consists of a metal head to fit the bore and a tube at one end of which is a handle. When the gas ejector is pushed down the barrel the burned gases are forced up through the handle and out of the gun. When the gas ejector is removed cold air is sucked through the handle and into the gun. The head is threaded to receive a wire brush or a sponge head whenever it is desirable to clean or sponge out the bore.



METHOD OF LOADING TRENCH MORTAR.

The projectile is a cast iron fragmentation shell with vanes, weighing approximately 42 pounds unloaded, and containing a bursting charge of approximately 11 pounds of high explosive. The projectiles are fitted with delay and nondelay fuzes.

The propelling charge consists of sporting ballistite contained in silk bags of 1 and 2 ounces capacity. With these two sizes of bags a number of combinations can be obtained and the range can be varied according to these combinations. The maximum charge is

9 ounces and the minimum 3 ounces. The bags are held in place between the vanes of the shell by a propelling bag holder. The charge is ignited by an ignition cartridge made from a standard rifle cartridge which is fired when it strikes the firing pin as the shell reaches the bottom of the barrel.



REAR VIEW OF MORTAR.

Weights, ballistics, etc.

Overall length of barrel.....	inches..	57
Weight of barrel.....	pounds..	162
Weight of base.....	do....	75
Weight of platform.....	do....	160
Weight of sub-base.....	do....	530
Weight of shell, loaded (approximately).....	do....	53
Weight of shell box.....	do....	10
Range, minimum.....	meters..	200
Range, maximum.....	do....	1,700

PROSPECTUS.

The trend of design for field artillery now proposed and under way shows several digressions from the present practice.

Motor transportation promises to almost completely revolutionize artillery design. A motor-drawn carriage is not so limited in weight as the horse-drawn type, thus permitting heavier and more powerful weapons. At the same time the carriage must be designed to withstand the more severe usage of motor traction.

A further development along the line of motor transportation is the self-propelled caterpillar mount for field artillery. The performance of the experimental mounts of this type has been very satisfactory, and no doubt manufacture in quantity will be ordered in the near future. The piece is mounted with a suitable top carriage directly on the caterpillar, and thus forms a self-contained unit capable of rapid and easy maneuvering. This type of mounting permits of carrying various calibers of guns and howitzers, and has the further advantage of permitting all around traverse by maneuvering the vehicle under its own power. They are also able to negotiate rough and difficult terrain more readily than any other type of vehicle yet developed.

The self-propelled caterpillar, Mark II, 8 units of which have been recently issued to the service, is a road vehicle of the track-laying type; that is, the power is transmitted to the ground through a flexible, endless track composed of steel shoes, instead of directly through the drive wheels as in the usual type of truck construction.

This caterpillar has been designed and constructed to mount the 155 mm. gun, and be able to withstand its firing stresses. Although not primarily a hauling or towing type of machine, it is provided with a rear pintle for towing an ammunition trailer or similar vehicle. On each side at the front of the main frame draw hooks are provided for towing the mount when necessary.

The various units composing the vehicle are assembled on the main frame which is a rigidly reinforced steel casting. The main frame is supported on the track by truck roller frames on which it rests through the medium of an equalizing mechanism and spring buffers.

The power unit of this vehicle is mounted longitudinally at the forward end beneath the muzzle end of the gun, consisting of a Sterling "FT" six-cylinder internal combustion engine with its fuel, carburetion, ignition, lubrication, and cooling systems.

The power developed is transmitted to the drive sprockets, which drive the track through the following power system. A master clutch controls the application of power between the engine and main transmission unit containing selective gears by which the speed and direction of travel are controlled. From the transmission unit the power is transmitted to two propeller shafts through the steering clutches and reducing planetaries. These propeller shafts transmit the power from the intermediate transmission to the final drive gears on the drive sprockets.

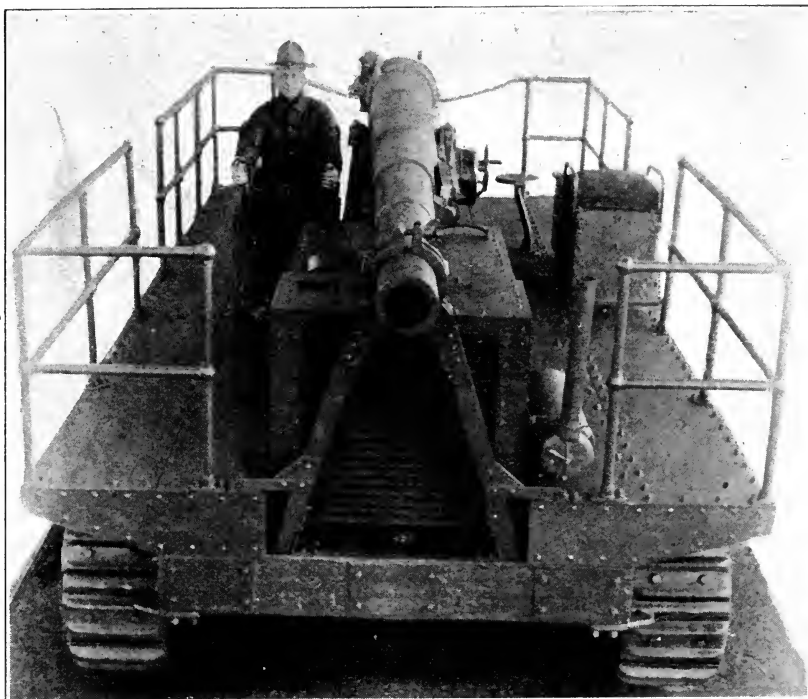

PLAN VIEW OF SELF-PROPELLED CATERPILLAR, MARK II.

The driving mechanism is so designed that the forward travel of the vehicle is the pointing direction of the gun. The combination of selective and planetary gears provides four speeds forward and two reverse. The direction and speed of travel are under the direct control of a single operator, seated where he is able to obtain full view ahead and may readily gain access to engine in case of emergency.

The planetary brake, the master clutch, and the gear shift are operated by hand levers. The planetary brake and steering clutch on the same propeller shaft are operated by the same lever. Having a separate lever for each propeller shaft the steering clutches and planetaries can be operated separately or simultaneously, as desired, and in this way the vehicle is steered.

When both steering levers are in the forward position, the steering clutches are engaged, and power is transmitted to both tracks at the direct speed. By placing the right steering lever in the central or neutral position, the right steering clutch is disengaged and power is transmitted to the left track only and the vehicle can be made to turn sharply to the right by applying the right steering clutch brake.

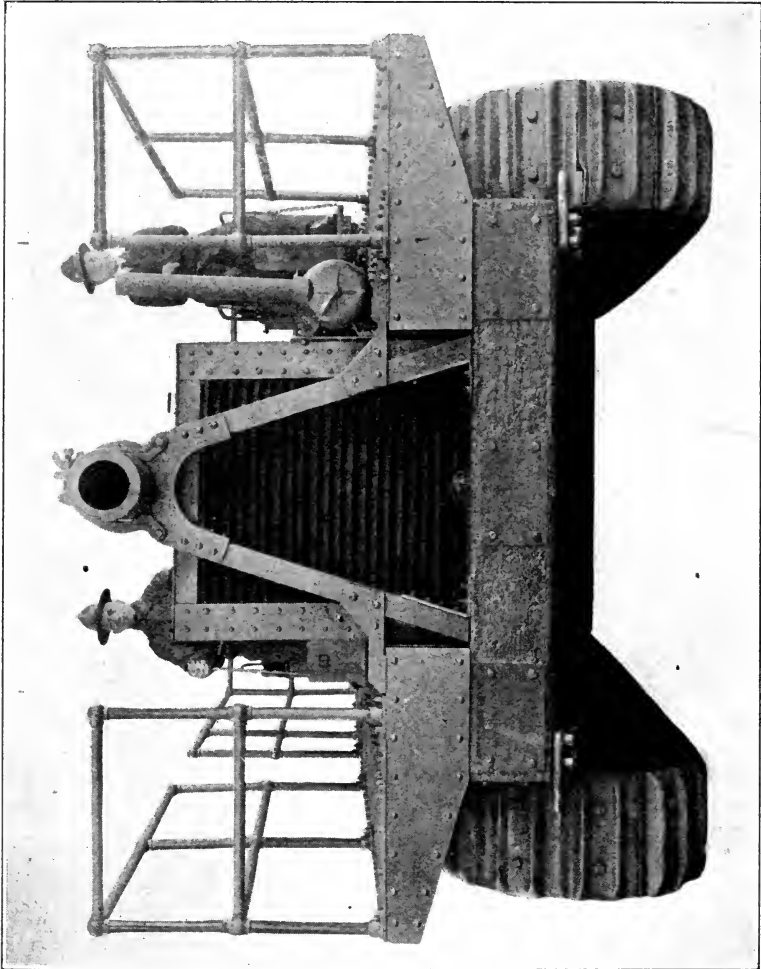

FRONT VIEW OF SELF-PROPELLED CATERPILLAR, MARK II.

Placing the right steering clutch lever in the rear position sets the planetary brake and reduces the speed of the right so that the vehicle turns slowly to the right. In a similar manner the vehicle can be turned to the left by the use of the left steering lever. Applying both planetaries at the same time furnishes a reduced uniform speed to both tracks and a low gear ratio for a hard pull. With both

steering levers in neutral, or with the master clutch disengaged, both brakes may be set simultaneously by the use of the hand lever located between the two foot brake pedals. The speed and direction of the direct drive is controlled by the selective transmission gear-shift lever, which can only be operated when the master clutch is disengaged, thereby breaking the power between the engine and the transmission.

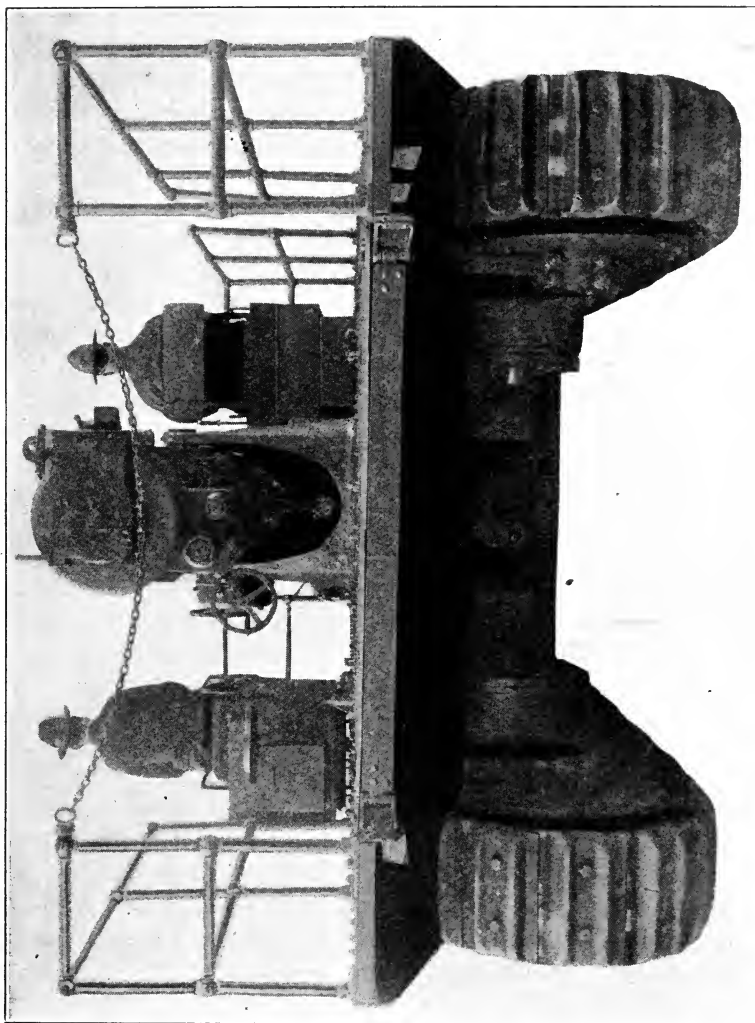

REAR VIEW OF SELF-PROPELLED CATERPILLAR, MARK II.

The steel deck plates directly over the transmission case, planetary brakes, and steering clutches are removable to provide ready access for repairs and adjustments. Doors are provided in the sides of the armor plate engine hood for the same purpose.

The equalizer arrangement is pivoted at the front end of the main frame and operates so that one track, when passing over a log or

obstruction, forces the track on the opposite side down into firm bearing with the ground, thus preventing the caterpillar tipping sideways, or the front end riding up and running down with a jar when the center of gravity passes over the obstruction. The forward end of the caterpillar is covered with steel plates forming a protecting nose when forcing its way through brush, trees, and other field obstructions.

The rear deck plates under the gun breech are hinged so that they may be folded back out of the way to enable the gun crew to load and handle the gun from the ground.

A traverse of the gun relative to the caterpillar of 5° to the right and 5° to the left is provided, which is sufficient for corrections and accurate pointing. Any necessary traverse beyond this limit is obtained by traversing the caterpillar vehicle under its own power by the use of the steering levers. Under ordinary ground conditions an all around traverse can be obtained in this way. The 0° to 35° range elevation of the standard wheeled carriage is retained in this mount.

A structural steel deck, with necessary guard railing is secured to side plates of main frame, and extending over the entire length of the tracks, thereby preventing accidents to the personnel during traveling, and may be conveniently used for mounting of the sight, tool and spare part chests, etc., when deemed necessary.

This self-propelled caterpillar type unit has successfully demonstrated its advantages, for, due to its mobility, it may readily be transported from place to place under unfavorable ground and weather conditions and is able to open fire immediately upon its arrival in a position. The advantage of this type of machine having artillery mounted directly on a vehicle with caterpillar treads for military purposes lies in its ability, due to very low unit ground pressure, to negotiate soft and uneven surfaces, impossible to the usual type of power vehicle, except under the most extreme difficulties.

Anti-aircraft guns are receiving careful attention with the view of further development of easily maneuvered and quickly handled pieces. They are mounted on self-propelled vehicles, as trucks or caterpillars, or on some easily drawn vehicle such as an autotrailer. They must of course be designed for all around and high angle fire. Used as they are against swiftly moving aircraft, special guns of high velocity and sights specially adapted to this work must be considered.

Several changes are apparent in the trend of design for new field-pieces of the wheeled type.

The desirability of wider traverse and higher angles of elevation has led to the development of the split trail carriage for both guns

and howitzers. Many of the newer guns permit of as high elevation as that of the howitzers.

Another development is that of interchangeable guns and howitzers for the same carriage. For example, one type of carriage being developed is that for mounting a 75 millimeter gun or a 105 millimeter howitzer.

The hydro-spring type of recoil mechanism seems to be almost entirely superseded in the latest designs by the hydropneumatic recoil mechanism.

The tendency in latest practice is to relieve the carriage from road shocks as much as possible by the use of spring suspension and rubber-tired wheels.

The desirability of small light fieldpieces which can be taken to the front by the infantry has led to the infantry accompanying gun and howitzer. Some of the latest experimental guns of this type are 2.24-inch pieces so light that they are easily moved by man power.

In general, it will be seen from the above that future artillery will more nearly approach the ideal, to the degree that the principles of high power and swift transportation are incorporated in the design.







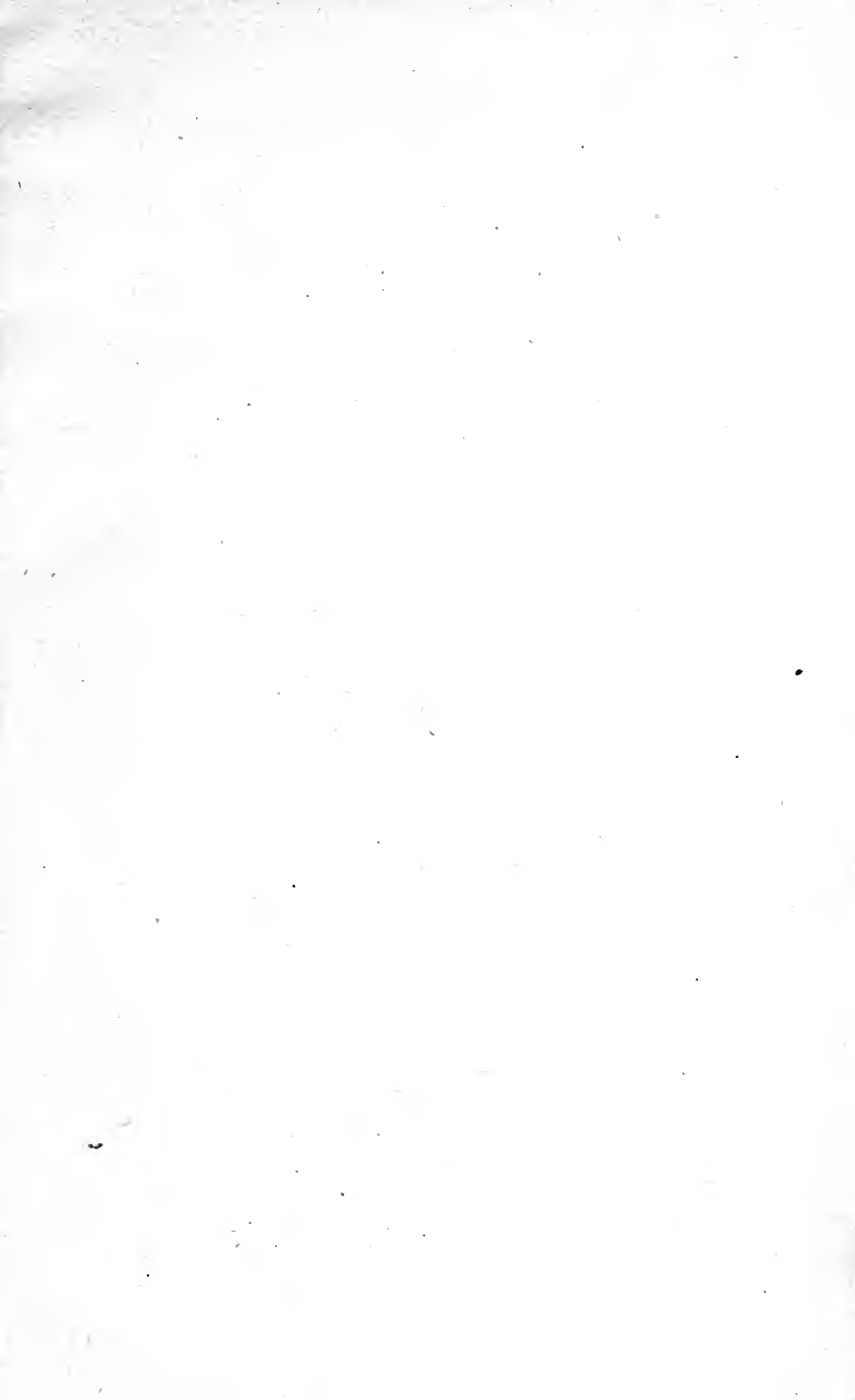

UNIVERSITY OF CALIFORNIA LIBRARY,
BERKELEY

**THIS BOOK IS DUE ON THE LAST DATE
STAMPED BELOW**

Books not returned on time are subject to a fine of 50c per volume after the third day overdue, increasing to \$1.00 per volume after the sixth day. Books not in demand may be renewed if application is made before expiration of loan period.

T 25 1928

DEC 18 1924

FEB 16 1927

Mar 25 1927

JAN 10 1929

24

Feb. 7

" 21

~~12/11/60RR~~

REC'D LD

JUL 11 1960

4 Jun '64 BG

REC'D LD

JUN 29 '64 - 12 M

432322

UFN3

A3

UNIVERSITY OF CALIFORNIA LIBRARY

